



## **LETTER OF TRANSMITTAL**

**TO: HOLDERS OF 1124/1124A WESTWIND MANUALS**

Included with the enclosed Revised Service Data Book Index Pages are current revision listings for the Westwind manuals and microfiche. Please compare these listings to your manuals to ensure they are current.

It is also recommended you compare the Service Data Indexes to your Service Data Books to ensure this data is current.

Please send any discrepancies or missing publication requests to:

**Astra Jet Corporation  
Technical Publications  
Post Office Box 10086  
Wilmington, DE 19850**

or FAX to: 302-324-5159, Attention: Technical Publications

WW: Wiring Diagram Manual Temp # 28-1  
30-1  
+ Rev 20

Last Done Dec 15, 1981

Fiche: MX manual 12-1A Apr 12/95

SB'S

- 1124-29-014  
Rev #1  
Feb 2/18/86 Emerg. hyd. pump protec. Cover installation
- ✓ 1124-35-021  
10/21/88 Horiz. Sub. Assy. - Insp, Repair + Improvement (AFC 2037)
- 1124-23-041  
6/14/85 Bypass of CTL(XX) Control Head Volume Controls
- 1124-24-043  
6/8/92 Starter/Generator Field Circuit Wiring Modification
- 1124-34-047  
12/11/91 Nav. Static Source Improvement for Co's Alt.
- 1124-34-064  
2/16/87 Nav. Repeat VOR/LOC Switching Improvements
- 1124-30-090  
9/8/89 - Ice + Rain NAC/ENG Anti-Ice Switch Reliability  
(AFC 2071)
- 1124-034-099  
9/1/89 - Nav. Pitot Head - exchange of certain Aero Instruments  
Company P/N #1100 Pitot heads
- 1124-11-103  
11/26/90 Placards + Markings - Towing Instruction placard Replacement  
(AFC 2074)
- 1124-27-104  
6/17/92 Flight Controls - Relocate Bonding Jumpers Between  
Horizontal + Vertical Stabilizers + Control Surfaces  
(AFC 1056)
- 54-112  
10/7/92 Nacelles - Cowling Door Corrosion Inspection Prevention +  
Repair
- ✓ - 32-116  
11/23/94 Landing Gear - Nose wheel steering system - Steering  
Cable control Diagram

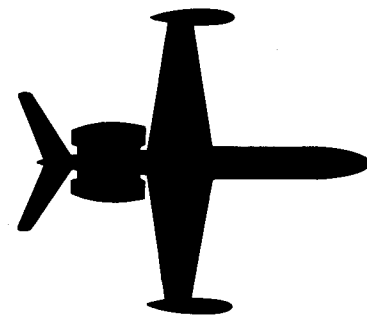

## SERVICE DATA

---

---

### SERVICE DATA CHAPTER INDEX

<u>CHP</u>	<u>TYPE</u>	<u>PUB NO.</u>	<u>SUBJECT</u>
	SIL	03	CANCELLED
	SIL	01A	Service Information Letter
	SL	WW-2479A	Horizontal Stabilizer Hinge Inspection
	SL	WW-2478 Rev. No. 1	Inspection and Lubrication of Drive Coupling in Hydraulic Pumps P/N 713524
	SL	WW-2474 Rev. No. 1	Inspection of Aileron Control for Freeplay
	SL	WW-2457 Rev. No. 1	Wing Flap Hinge and Bearing Inspection
	SL	WW-2427C	50-Hour Phase Inspection
	SB	WW-24-14	Inspection of Horizontal Stabilizer Hinge Fitting
5	SIL	37 Rev. No. 1	Emergency Exit Checks
5	SIL	15	1124 Time Limit Changes
5	SIL	1124-05-097	Time Limits/Maintenance Checks - Pressure Cylinders Hydrostatic Test Interval Revisions
5	SIL	1124-05-088 Rev. No. 1	Time Limits/Maintenance Checks - Structural Inspection Program
5	SIL	1124-05-079 Rev. No. 2	Time Limits/Maintenance Checks - 50-Hour Phase Inspection
5	SL	WW-2420F	Time Limits/Maintenance Checks - Chapter 5
9	SIL	1124-09-077	Towing and Taxiing - Proper Towing Procedures

SERVICE DATA CHAPTER INDEX

<u>CHP</u>	<u>TYPE</u>	<u>PUB NO.</u>	<u>SUBJECT</u>
11	SIL	1124-11-094	Placards - Protection From Skydrol Damage
11	SL	WW-2445A	Placard - Take Off and Landing Limitations Placard
11	SB REC	1124-11-103	Placards and Markings - Towing Instruction Placard Replacement (AFC 2074)
11	SB REC	1124-11-088A	Placards & Markings - Overwing and Single Point Fueling Filler Ports Placard Replacement
12	SIL	1124-12-110	Servicing - Rental Tooling/Components Available Through Astra Jet Corporation
12	SIL	1124-12-061	Servicing - Over Wing Refueling Ports
20	SIL	1124-20-111	Standard Practices - Unairworthy Emergency Equipment
20	SIL	1124-20-106	Standard Practices - Noise Level Certificate
20	SIL	1124-20-104	Standard Practices - Airfield Crash Crew Information
20	SIL	1124-20-102	Standard Practices - Airworthiness of Parts
20	SIL	1124-20-072	Service Bulletin - Compliance Designations
21	SIL	36	1124 Westwind Refrigeration Unit Installaltion
21	SIL	32	Replacement of P/N 572375-3 Cooling Turbine with P/N 572375-2 Cooling Turbine
21	SIL	19	Application Instructions for Skin Temperature Sensor
21	SIL	14	Airesearch Service Information Letter No. 21-L-522
21	SIL	12	Airesearch Service Information Letter No. 21-L-526
21	SIL	1124-21-109	Air Conditioning - Improved Refrigeration Bypass Valve
21	SIL	1124-21-085	Air Conditioning - 35 Degree F Temperature Control Sensor Installation

SERVICE DATA CHAPTER INDEX

<u>CHP</u>	<u>TYPE</u>	<u>PUB NO.</u>	<u>SUBJECT</u>
21	SIL	1124-21-078 Rev. No. 1	Air Conditioning - 35 Degree Temp Sensor Connector - Reliability Improvements
21	SIL	1124-21-069	Air Conditioning - Improved Bleed Switching Valve Body Seals
21	SIL	1124-21-066 Rev. No. 3	Air Conditioning - Improved Bleed Switching Valve (Garrett P/N 3213894-4-1)
21	SIL	1124-21-043	Improved Gaskets for Bleed Switching Valve
21	SIL	1124-21-017	Cooling Turbine - Oil Sump Drain Plug Accessibility Improvement
21	SIL	1124-21-014	Pressurization - Maintenance of Outflow Valves
21	SIL	1124-21-013	Approved Alternate Lubricants for Airesearch Cooling Turbine 572375-1-2 and -3
21	SIL	1124-21-007 Rev. No. 1	Adjustment Procedures for the 3213894-1-1 Bleed Switching Valve
21	SIL	1124-21-001	Pressurization - Deletion of Adjustment for Fluid Pressure Regulator Valve
21	SL	WW-2471	Improve Emergency Overheat Light Indication
21	SL	WW-2458	Removal of Cooling Turbine Dipstick
21	SL	WW-2449A	Inspection of ECU Mount Assembly P/N 5783588-1
21	SL	WW-2449 Rev. No. 1	Inspection of ECU Mount Assembly P/N 5783588-1
21	SL	WW-2446	Marking of Oil Dipstick for the ECU
21	SL	WW-2442 Rev. No. 2	Adaptor Kit for 2200165-2 and -3 Refrigeration Unit
21	SL	WW-2410A	Modification of Environmental Control System Wiring
21	SL	WW-2405	Removal of Air Conditioning Muffler
21	SL	WW-2403	Glareshield Ventilation Openings
21	SB	WW-24-1A	Improved Cooling of E.C.U. from Ram Air Inlet to E.C. Bearing (External Area) and Modifying Ram Air Exhaust Port to Different Shape

SERVICE DATA CHAPTER INDEX

<u>CHP</u>	<u>TYPE</u>	<u>PUB NO.</u>	<u>SUBJECT</u>
21	SB OPT	1124-21-115 Rev. No. 1	Air Conditioning - Improve Operation of Cabin Auto Temp System
21	SB REC	1124-21-108	Air Conditioning - Water Separator Duct Clamping Improvement (AFC 2077)
21	SB OPT	1124-21-089	Air Conditioning - Incorporation of Refrigeration Unit Overtemperature Protection System (OPS)
21	SB OPT	1124-21-076A	Air Conditioning - Improved Cap Assembly for Unused Port on Air Gasper P/N 2708 "WEMAC"
21	SB REC	1124-21-029	Baggage Compartment Heat System
21	SB OPT	1124-21-028	Reduction of Cooling Air Volume to Both DC Contactor Boxes and Closure of Air Outlet Near Battery Installation
22	SIL	07	AP105/APS80 Capstan Tension Tests, 1123, 1124, and 1124A Westwind Series Aircraft
22	SIL	1124-22-076	Auto Pilot-Altitude Preselect Errors
22	SIL	1124-22-075	Auto Pilot - Vertical Gyro Precession
22	SIL	1124-22-068	Autopilot - To Reduce Roll Axis Cycling and Improve Vertical Mode Performance
22	SIL	1124-22-065A	Autopilot - To Reduce Roll Axis Cycling
22	SIL	1124-22-056	Inadvertent Annunciator Lamp Control
22	SIL	1124-22-045B	Six-Pole Relay Contact Failures and Replacement Information
22	SIL	1124-22-042	Horizontal Trim Actuator Response Time
22	SIL	1124-22-039	Vertical Gyro Improvements
22	SIL	1124-22-038	Vertical Gyro Adjustment Procedure
22	SIL	1124-22-011 Rev. No. 1	Air Data/Computer and Altimeter Certification for 1124A
22	SIL	1124-22-004	Pilot and Copilot Annunciator Panel Interconnect Plug Wiring
22	SL	WW-2455 Rev. No. 1	Improvement of FDS/FCS System Responses in Lateral Mode
22	SL	WW-2451	Improvement of FDS/FCS System Responses in Vertical Modes

SERVICE DATA CHAPTER INDEX

<u>CHP</u>	<u>TYPE</u>	<u>PUB NO.</u>	<u>SUBJECT</u>
22	SB	WW-24-29	Prevention of Improper Flight Director Glideslope Display
22	SB OPT	1124-22-079	Autoflight - Establish Linear Deviation Steering Command to Autopilot
22	SB REC	1124-22-072A	Autoflight - Elevator and Rudder Servo Idler Arm - Install New Attach Bolts
22	SB OPT	1124-22-056	Autoflight - Correction of Flight Director Annunciator Self-Test Circuit
22	SB OPT	1124-22-032	Collins VNI-80 ( ), Vertical Navigation Indicator Altitude Preslave Switch
22	SB OPT	1124-22-031	Vertical Gyro Fast Erect Switch
22	SB REC	1124-22-025A	Autoflight - Elimination of 1124A Overspeed Warning Failures
22	SB OPT	1124-22-024 Rev. No. 1	Elimination of FCS 105 Altitude Mode Transition Errors
22	SB OPT	1124-22-018	Autoflight - Nuisance Autopilot Disengagement
22	SB OPT	1124-22-001	Navigation - Alternate Location for G/A (Go Around) and Vertical Sync Buttons
23	SIL	25	Aft Baggage Compartment Mic Wiring Conformity Check
23	SIL	24	Microphone System Update
23	SIL	23	Intercom System Audio Clarity Rev.
23	SIL	1124-23-060	Communications - Audio - Sidetone Adjustment Procedures
23	SIL	1124-23-049 Rev. No. 1	CTL 20/30 COM/NAV Control Interchangeability
23	SIL	1124-23-048	Aircraft Microphones and COM Unit Adjustment
23	SIL	1124-23-047	Collins HF220 System Improvements
23	SIL	1124-23-044	To Prevent Failure of Stereo System and "L" Pad Cabin Volume Controls
23	SIL	1124-23-016	Static Wick and Base Bonding Tests
23	SL	WW-2495A	HF System Improvements
23	SL	WW-2454	Improper Transmitter Modulations

SERVICE DATA CHAPTER INDEX

<u>CHP</u>	<u>TYPE</u>	<u>PUB NO.</u>	<u>SUBJECT</u>
23	SB	WW-24-25	Rockwell-Collins Service Bulletin No. 3 for CTL-20, CTL-60 and CTL-90 Controls, and Service Bulletin No. 4 for CTL-30
23	SB	WW-24-23	Replacement of Audio Load Resistor, R-61
23	SB OPT	1124-23-082	Communications - Replacement of Audio Selector Panel Volume Controls
23	SB OPT	1124-23-081A	Communications - Alternate VHF COM 1 Antenna
23	SB OPT	1124-23-080	Communication - Elimination of Cross-Side Transmitter Sidetone
23	SB OPT	1124-23-074 Rev. No. 1	Communications - Radio Telephone Improvements and Corrections
23	SB OPT	1124-23-073	Communications - DMQ-18-1A ELT Antenna Hum Correction During High Speed Flight
23	SB OPT	1124-23-051	Communications - Stereo System Improvements
23	SB OPT	1124-23-050	Communications - VHF COM 3 System Improvements
23	SB OPT	1124-23-046	Replacement and Relocation of Flight Telephone Antenna
23	SB OPT	1124-23-041	Bypass of CTL(XX) Control Head Volume Controls
23	SB OPT	1124-23-038 Rev. No. 1	Stereo Configuration Errors
23	SB OPT	1124-23-033 Rev. No. 1	400 Cycle Hum in VHF COM Modulation
23	SB OPT	1124-23-016 Rev. No. 2	Installation of Additional and Improved Static Wicks
23	SB OPT	1124-23-013	VHF COM and Audio System Conformity
24	SIL	28	Learavia Battery Temp System Tests, 1124/1124A Westwinds
24	SIL	04	Generator Control Wires 1P16B and 1P17B on Left Engine and 2P16B and 2P17B on Right Engine
24	SIL	1124-24-091	Electrical - Lucas Aerospace (Lear Siegler) Starter Generator Bearing Replacement



SERVICE DATA CHAPTER INDEX

<u>CHP</u>	<u>TYPE</u>	<u>PUB NO.</u>	<u>SUBJECT</u>
24	SIL	1124-24-054	AC Static Inverter Improvements
24	SIL	1124-24-037	Storage of Nickel Cadmium Aircraft Batteries
24	SIL	1124-24-023	Minimizing Precipitation Static Interference through Proper Aircraft Bonding
24	SIL	1124-24-019B	Distribution Bus Circuit Breaker Inspection
24	SIL	1124-24-006	Alternate Part for Engine Pylon Firewall Bulkhead Connectors J313 and J314
24	SIL	1124-24-005 Rev. No. 1	Inspection and Test of Priority Bus Diodes
24	SL	WW-2496	Battery Switch Wiring Modification
24	SL	WW-2485	External Power Control Circuit Improvement
24	SL	WW-2483 Rev. No. 1	Feeder Protector Relay Mounting Improvements
24	SL	WW-2480	Generator Cable Shield
24	SL	WW-2473	One Time Inspection and Protection of Wire Bundle Routed above Cockpit Overhead Circuit Breakers
24	SL	WW-2467	One Time Inspection of Wire Bundle Routed above "No Smoking-Fasten Seat Belts" Warning Sign for Chafing
24	SL	WW-2461 Rev. No. 1	Replacement of Generator Start Contactor (GSC)
24	SL	WW-2421	External Power Fuse Replacement
24	SB	WW-24-27	General Electric DC Starter Generator Model 2CM504D2D Limitations and Ammeter Markings
24	SB	WW-24-26	Removal of Zener Diodes and Resistors from Air Data Power Supply Circuits
24	SB	WW-24-20 Rev. No. 1	Part I - Inspection of Electrical Wires for Chafing Against Upper Hot Liquid Container in Galley, Part II - Rerouting of Electrical Wiring Behind Hot Liquid Container Compartments of Galley P/N CMA521288

## SERVICE DATA CHAPTER INDEX

<u>CHP</u>	<u>TYPE</u>	<u>PUB NO.</u>	<u>SUBJECT</u>
24	SB	WW-24-12	Inspection of Generator Circuit Resistors R-11 and R-12
24	SB	WW-24-4B Rev. No. 1	Inspection of Generator Control Units
24	SB OPT	1124-24-120	Electrical Power - Improved Ground Returns
24	SB REC	1124-24-075 Rev. No. 1	Electrical Power - Cockpit Voice and Flight Data Recorder Bus Change
24	SB REC	1124-24-065	DC Electrical System - Remote Circuit Breaker Random Tripping
24	SB OPT	1124-24-054 Rev. No. 1	Electrical Power - Fuel Quantity and ITT Gauges to Priority Bus
24	SB OPT	1124-24-043 Rev. No. 2	Starter/Generator - Field Circuit Wiring Modification
24	SB REC	1124-24-008 Rev. No. 2	Installation of Larger Capacity Priority Bus Diodes and Elimination of Ground Pressure Bumps
25	SIL	1124-25-096	Equipment/Furnishings - Extended Over Water Operations, Safety and Survival Equipment
25	SIL	1124-25-095	Equipment/Furnishings - Monogram Series 15500 Toilet Maintenance
25	SIL	1124-25-059 Rev. No. 1	Portable Fire Extinguishers
25	SIL	1124-25-055	Sherwood Toilet P/N 2051 Timer Failures
25	SIL	1124-25-027	Improved Stereo Speaker Clarity
25	SIL	1124-25-010	Passenger Seat Recline Control Removal/Installation Improvement
25	SL	WW-2447	Inspection of Seat Belt Attaching Bolt for Looseness
25	SB	WW-24-22	Inspection of Pilot and Copilot Seat Attachment
25	SB OPT	1124-25-117	Equipment/Furnishing - Passenger Life Vest Accessibility
25	SB OPT	1124-25-085	Equipment/Furnishings - Crew Seat Slide Release Arm Assembly Improvement
25	SB OPT	1124-25-063A	Equipment/Furnishings - Hot Liquid Container

## SERVICE DATA CHAPTER INDEX

<u>CHP</u>	<u>TYPE</u>	<u>PUB NO.</u>	<u>SUBJECT</u>
25	SB REC	1124-25-006	Cockpit Panels - Installation/Rework
26	SL	WW-2499 Rev. No. 1	Modification of Left Engine Bleed Air Leak Detector Installation
26	SB REC	1124-26-119	Fire Protection - Inspection of Aft Fire Extinguisher Line in Left and Right Engine Pylons
26	SB OPT	1124-26-022 Rev. No. 2	Fire Protection - Addition of Sonalert Horn to Fire Warning System
27	SIL	18 Rev. No. 1	Flap System Flex Shaft Pin Replacement
27	SIL	1124-27-107	Flight Controls - Right Inboard Flap Flexible Drive Shaft Routing
27	SIL	1124-27-070	Flight Controls - Suggested Specialty Tooling for Control System Free Play Measurement
27	SIL	1124-27-064	Horizontal Trim Actuator - Axial Play
27	SIL	1124-27-063	To Announce the Availability of a New EMI Filter
27	SIL	1124-27-057	Rudder and Tabs - Synchronization of Dual Actuators
27	SIL	1124-27-030 Rev. No. 1	Measurement Limits of Aileron Trim and Servo Tab Free Play
27	SIL	1124-27-028 Rev. No. 1	Flap Limit Switch Replacement
27	SIL	1124-27-002	Flap Asymmetry Comparator Control Box Failures and Nuisance Flap Imbalance Warnings
27	SL	WW-24105	Flight Controls - Horizontal Stabilizer Aural Warning Horn Replacement
27	SL	WW-2493 Rev. No. 2	Replacement of Both Flap Linear Potentiometers P/N 4 833523-1 with New P/N 4 833523-501
27	SL	WW-2489A	Horizontal Trim Electrical Wiring Modification
27	SL	WW-2464 Rev. No. 1	Replacement of Trim Tab Actuator Rod End Assy
27	SL	WW-2448	Flap Gear Box - Position Transmitter Protection

SERVICE DATA CHAPTER INDEX

<u>CHP</u>	<u>TYPE</u>	<u>PUB NO.</u>	<u>SUBJECT</u>
27	SL	WW-2424D	Inspection and Lubrication of Wing Flap Flexible Drive-Shafts
27	SL	WW-2423	Flap Control Circuit Breaker Replacement
27	SB	WW-24-19	Inspection of Aileron Control Pulley P/N 3533032-1
27	SB	WW-24-11	Replacement of Aileron Control Chain Assy P/N 3533516-1 and Sprocket P/N 2533049-501 in Flight Control Columns
27	SB MAN	1124-27-129	Flight Controls - Aileron Push-Pull Tube and Guide Roller Inspection
27	SB REC	1124-27-104 Rev. No. 2	Flight Controls - Relocate Bonding Jumpers Between Horizontal and Vertical Stabilizers and Control Surfaces (AFC 1056)
27	SB MAN	1124-27-100 Rev. No. 2	Flight Controls - Replacement of Left and Right Aileron Control Rod Assemblies P/N 513506-503
27	SB REC	1124-27-095	Flight Controls - F44-14 Rod-Ends - Inspection/Replacement
27	SB REC	1124-27-086	Flight Controls - Inspection and/or Replacement of LH and RH Elevator Reducer Tube Collars
27	SB REC	1124-27-062	Flight Controls - Speed Brake - Inadvertent Deployment
27	SB OPT	1124-27-061	Flight Controls - Wing Flap Actuators, Improvement/Repair
27	SB REC	1124-27-017	Flight Controls - Modification of Rudder Servo Trim Tab
27	SB	1124-27-012	Flap Acatuator - Improvement and Repair
27	SB	1124-27-003	Flight Controls - Flap Vane Inspection
28	SIL	30 Rev. No. 1	Use of BIOBOR®JF Fuel Additive
28	SIL	20B	Intertechnique Fuel Boost Pumps, P/N 5653744-1, -501 and -503 Brush Inspection
28	SIL	17	1124 Westwind Fuel Management Procedure
28	SIL	1124-28-103 Rev. No. 1	Fuel - Improved Fuel Boost Pump
28	SIL	1124-28-090	Fuel - Fuel Dump Stop Level Switch Precautions

SERVICE DATA CHAPTER INDEX

<u>CHP</u>	<u>TYPE</u>	<u>PUB NO.</u>	<u>SUBJECT</u>
28	SIL	1124-28-062	To Announce the Availability of a New Fuel Vent Valve
28	SIL	1124-28-026	Replacement of Firewall Fuel Shut-Off Valve Light Circuit Relay
28	SIL	1124-28-020A	Fuel - Dump Valve Interchangeability
28	SIL	1124-28-009	Wing Fuel Probe Gasket, Left and Right Outboard
28	SL	WW-2472	Installation of Cable Clamp on Fuel Boost Pump Ground Wires
28	SL	WW-2436	Installation of Additional Wiring in Fuel Measurement System
28	SL	WW-2434	Retrofit Installation of Redesigned Fuel Sump and New Main Boost Pumps
28	SL	WW-2418	Fuel Vent Valve Seal Replacement
28	SL	WW-2412	Engine Fuel Computer-Filter Installation
28	SB REC	1124-28-106	Fuel - Tip Tank - Sealing of Float Switch Wire Conduit
28	SB OPT	1124-28-098	Fuel - Preventing Fuel Spillage through Vent System During Refueling or Transfer Operations (AFC 2074)
28	SB REC	1124-28-087	Fuel - Removal of EMI Filters from Intertechnique Boost Pump Circuit
28	SB	1124-28-083	Fuel - Modification of Fuel Transfer Pump
28	SB OPT	1124-28-078	Fuel - Fuel Status System Improvements
28	SB OPT	1124-28-035 Rev. No. 1	Elimination of Erratic Fuel Quantity Indications
28	SB REC	1124-28-002 Rev. No. 1	Inspection of Fuel Sump Check Valve Lever and Installation of Manual Lever Handle Stop
29	SIL	1124-29-108	Hydraulic Power - Self-Sealing Couplings (Quick-Disconnects) Basic Overhaul Manual
29	SIL	1124-29-074	Hydraulic - Approved Use of Teflon Back-Up O-Rings
29	SIL	1124-29-067	Hydraulic Power - Suggested Inspection Methods for Aft Fuselage (Station 316) Hydraulic Lines

## SERVICE DATA CHAPTER INDEX

<u>CHP</u>	<u>TYPE</u>	<u>PUB NO.</u>	<u>SUBJECT</u>
29	SIL	1124-29-051	Hydraulic Power - Emergency Hydraulic Pump Shaft Seal Drain Fitting - Proper Installation Instructions
29	SL	WW-2492	Hydraulic Hose Inspection
29	SL	WW-2482 Rev. No. 1	Retrofit to Emergency Hydraulic Pump P/N 4713010-503
29	SL	WW-2481	Modification of Hydraulic Quick Disconnect Fitting Installation
29	SL	WW-2466	One Time Inspection and Installation of Tie-Wrap on Hydraulic Tubes in Wing Root Adjacent to Wing Rib (STA. Xw-33.000)
29	SL	WW-2429 Rev. No. 1	Hydraulic System Attenuator Installation
29	SL	WW-2415	Installation of Additional Check Valves into Hydraulic Reservoir Pressurization Source
29	SL	WW-2411B	Hydraulic Reservoir Standpipe Modification - Installation of Additional Filter Gasket and Replacement of Filter Element
29	SB	WW-24-10 Rev. No. 1	Chafing of Tubes near R.H. Engine Pylon
29	SB	WW-24-6	Chafing of Tubes in L.H. Engine Pylon and Relocation of Nitrogen Gauges and Charging Valves
29	SB	WW-24-5 Rev. No. 1	Engine Driven Hydraulic Pump Bypass Port Plug Replacement
29	SB OPT	1124-29-014 Rev. No. 1	Emergency Hydraulic Pump Protective Cover Installation
30	SIL	1124-30-080	Ice and Rain Protection - Engine HP Bleed manifold Assembly
30	SIL	1124-30-003	Pitot and AOA Heat Limitations
30	SL	WW-24106	Power Plant - Inspection and Replacement of Grumman Engine Inlet Anti-Ice Valves Manufactured by Sterer Engineering and Manufacturing Co., Serial Numbers 001 through 478
30	SL	WW-2465	Removal of Vertical Stabilizer Deicer Boot

SERVICE DATA CHAPTER INDEX

<u>CHP</u>	<u>TYPE</u>	<u>PUB NO.</u>	<u>SUBJECT</u>
30	SL	WW-2456	Pitot Heat Off Warning Light Installation
30	SL	WW-2444	Replacement and/or Rewiring of NAC/ENG Anti-Ice Control Switches
30	SL	WW-2430	Re-Calibration of Deice High Pressure Switch
30	SL	WW-2425	Installation of Additional Purging Hole in Birdproof Windshield
30	SB OPT	1124-30-090 Rev. No. 1	Ice and Rain - NAC/ENG Anti-Ice - Switch Reliability (AFC 2071)
30	SB REC	1124-30-066A Rev. No. 1	Ice and Rain Protection AOA and SAT TAS Probes Heat Wiring Improvement
30	SB REC	1124-30-036 Rev. No. 1	Ice and Rain, PART I Windshield Heat Control Wiring Modification, PART II Windshield Heat Cycling Contractor Inspection and/or Replacement
31	SIL	1124-31-093	Indicating - Recording Systems - Cockpit Voice Recorder Underwater Acoustic Beacon Field Maintenance
32	SIL	31A	Replacement of Brake Assembly to Axle Mounting Bolts
32	SIL	27	Upper and Lower NLG Bearing Precautions
32	SIL	11	Cold Weather Tire Precautions
32	SIL	05	Nose Wheel Steering System
32	SIL	1124-32-100	Landing Gear - Wheel Inspection And Overhaul Schedules
32	SIL	1124-32-098	Landing Gear - Nose Wheel Bolt Hole Repair
32	SIL	1124-32-089	Landing Gear - MLG Tire Shoulder Cracks
32	SIL	1124-32-041	Goodyear Nose Gear Bearing Seals
32	SIL	1124-32-033	Main/Nose Landing Gear - Revised Limit Switch Adjustments
32	SIL	1124-32-022	Steering Yoke - Grease Fitting Replacement
32	SL	WW-24107	Landing Gear - Addition of Optional Anti-Skid Indicator Lights
32	SL	WW-24103	Inspection and Replacement of Brake Assembly to Axle Mounting Bolts

SERVICE DATA CHAPTER INDEX

<u>CHP</u>	<u>TYPE</u>	<u>PUB NO.</u>	<u>SUBJECT</u>
32	SL	WW-24101	Typical Repairs for MLG Strut Door
32	SL	WW-24100	58 Degree Nose Gear Steering Modification
32	SL	WW-2494 Rev. No. 3	One Time Replacement of MLG Actuating Cylinder Inboard Attach Bolts, Inspection of Inboard and Outboard MLG Actuating Cylinder Attach Points and Lubrication Requirements for the Attach Points
32	SL	WW-2491 Rev. No. 1	Inspection and Lubrication of NLG Upper and Lower Outer Body Bearings and Upper Bearing Retaining Nut Seal Improvement
32	SL	WW-2488	Goodyear Service Bulletin 1124-32-3
32	SL	WW-2486	Moisture Drain for Main Landing Gear Axles
32	SL	WW-2477 Rev. No. 1	Nose Landing Gear Door Bellcrank Attach Bolt Check
32	SL	WW-2439A	Availability of Improved Main Landing Gear Piston Plug and Retaining Bolt
32	SL	WW-2431	Installation of Brake Wiring Support Bracket
32	SL	WW-2428 Rev. No. 1	Gear Horn Override System Installation
32	SL	WW-2426 Rev. No. 1	Nose Wheel Steering Sensitivity Improvement
32	SL	WW-2413	Wire Chafing in Nose Gear Well
32	SL	WW-2409B	Nose Gear Steering Roll Pin Replacement at Steering Wheel and Universal Joint
32	SL	WW-2402 Rev. No. 1A	Main Landing Gear - Parallelism Requirements
32	SB	WW-24-28A Rev. No. 1	Landing Gear-Inspectin of Nose Landing Gear Outer Strut-Body Forging
32	SB	WW-24-15 Rev. No. 1	Power Brake Valve - Replacement of Poppet Retainer Pin P/N 117W50D12
32	SB	WW-24-9 Rev. No. 1	Modification of Main Landing Gear
32	SB OPT	1124-32-110	Landing Gear - Emergency Gear Down Handle
32	SB REC	1124-32-105 Rev. No. 1	Landing Gear - Nose Landing Gear Door Modification (AFC 1055)



SERVICE DATA CHAPTER INDEX

<u>CHP</u>	<u>TYPE</u>	<u>PUB NO.</u>	<u>SUBJECT</u>
32	SB REC	1124-32-096	Landing Gear - F44-14 Rod-Ends - Inspection/Replacement
32	SB REC	1124-32-094	Landing Gear - Selector Valve Arm - Secure Roll Pin (AFC 2063)
32	SB REC	1124-32-045 Rev. No. 1	Inspection of MLG Actuating Cylinder Inboard Rod-End Bearings and Attach Bolts
32	SB OPT	1124-32-030 Rev. No. 1	Rerouting of Nose Landing Gear Wiring Harness
32	SB OPT	1124-32-009	Gear Warning Horn Automatic Disable
33	SIL	1124-33-101	Lighting - Alternate Cockpit Map Light
33	SIL	1124-33-099	Lights - Cabin Fluorescent Support System Parts Upgrade/Replacement
33	SIL	1124-33-099 Rev. No. 1	Lights - Cabin Fluorescent Support System Parts Upgrade/Replacement
33	SIL	1124-33-084	Lighting - Tip Tank Strobe Light Wiring
33	SIL	1124-33-058	Electrical Noise Radiation from Cabin Fluorescent Lighting System
33	SIL	1124-33-032	Lighting - Cockpit Glareshield - Floodlight Improvement
33	SIL	1124-33-025 Rev. No. 1	Failure of Aircraft System and Lamp Test Function
33	SIL	1124-33-008	Staco Switch and Lamp Assemblies
33	SL	WW-2484 Rev. No. 1	Deletion of Glareshield Lighting Forward Pressure Bulkhead Connector
33	SL	WW-2463 Rev. No. 1	Replacement of PS-274A Power Supply (MFG. EMP) with Power Supply LT-52A (MFG. KGS)
33	SL	WW-2417	Drainage for Upper Anti-Collision Light Mechanism
33	SB REC	1124-33-122	Lights - Tip Tank Strobe Light Wiring Conduit
33	SB REC	1124-33-121	Lights - Cabin Fluorescent Lighting Support System Improvement
33	SB OPT	1124-33-069	Lights - Change in Power Source for Cabin Lighting System
33	SB OPT	1124-33-060	Lights - Instrument Light Intensity and Dimmer Balance

SERVICE DATA CHAPTER INDEX

<u>CHP</u>	<u>TYPE</u>	<u>PUB NO.</u>	<u>SUBJECT</u>
33	SB OPT	1124-33-058 Rev. No. 2	Lights - Corrections and Improvements to Dimming System for Avionics Digital Displays
33	SB OPT	1124-33-034 Rev. No. 1	Logo Light Modification
33	SB REC	1124-33-010 Rev. No. 2	Emergency and Entrance Light Module Corrections
34	SIL	35	Vibration Level for #2 Altimeter
34	SIL	34	Intermittent Collins Rack Mount Connectors
34	SIL	26	#1 or #2 Compass System - DG Switch Modification
34	SIL	22	Sperry GH14A/B Attitude Gyro Installations
34	SIL	21	NCS31A Read Out Problems
34	SIL	13 Rev. No. 1	Rockwell-Collins WXR300 Radar System Dessicant Replacement
34	SIL	10 Rev. No. 2	Ledex Rotary Solinoid Failure
34	SIL	09	Reduction of Pitch Bumps, 1124 Westwind Series
34	SIL	08	Manual VOR/RNAV Select, 1124 Westwind Series
34	SIL	06	ADF 60 Accuracy, 1124 Westwind Series
34	SIL	1124-34-112	Navigation - Weather Radar Antenna
34	SIL	1124-34-086 Rev. No. 1	Navigation - Weather Radar Antenna
34	SIL	1124-34-073 Rev. No. 1	Weather Radar - Collins IND-300 Weather Radar Indicator Mandatory Service Bulletin
34	SIL	1124-34-053	FMS-90/LRN-85/GNS-500 Backlighting
34	SIL	1124-34-052 Rev. No. 1	NCS/FMS Electro-Magnetic Interference Problems
34	SIL	1124-34-050	HSI-84/REU-84 Modification/Status Changes
34	SIL	1124-34-046	NCS31/A Slant Range Correction
34	SIL	1124-34-040	Radar Stabilization Improvements

SERVICE DATA CHAPTER INDEX

<u>CHP</u>	<u>TYPE</u>	<u>PUB NO.</u>	<u>SUBJECT</u>
34	SIL	1124-34-036	AOA System - Component Replacement
34	SIL	1124-34-031A Rev. No. 1	Pilot and Copilot Annunciator Panel Cable Bundle Chafing/Shorting
34	SIL	1124-34-021	Installation of Chafe-Guard Material on Wire Bundles at Station 269 Near Emergency Gyro Power Supply
34	SIL	1124-34-012 Rev. No. 1	Coaxial Cable Clamping
34	SL	WW-24108	Navigation - Improved Pitot/Static System Drain
34	SL	WW-2460A	Navigation Equipment - Installation of Guard to Prevent GNS 500A RCU Mounting Latch Interference
34	SL	WW-2453	Reduction of Noise Spillover into Audio System
34	SL	WW-2452 Rev. No. 1	Improvement in System Reliability and Operation (NCS31/31A)
34	SL	WW-2422 Rev. No. 1	Angle of Attack Adjustment
34	SL	WW-2414	Inspection of Angle of Attack Indexes
34	SB OPT	1124-34-109	Navigation - Static Port Tubing Slope Inspection and Correction
34	SB REC	1124-34-099	Navigation - Pitot Head - Exchange of Certain Aero Instruments Company P/N PH1100 Pitot Heads
34	SB REC	1124-34-071 Rev. No. 1	Navigation - Copilot's Altimeter Part Number Changes
34	SB OPT	1124-34-070	Navigation - VLF/Omega Receiver Performance Improvement
34	SB OPT	1124-34-067	Navigation - Retrofit of Collins Vertical Gyro(s) and Improved Vertical Gyro Mounting
34	SB OPT	1124-34-064 Rev. No. 1	Navigation - Repeat VOR/LOC Switching Improvements
34	SB OPT	1124-34-057 Rev. No. 1	Navigation - NCS-31 Display and Logic Power Supply Improvements
34	SB REC	1124-34-055	Navigation - FMS-90/LRN-85 Improvements

SERVICE DATA CHAPTER INDEX

<u>CHP</u>	<u>TYPE</u>	<u>PUB NO.</u>	<u>SUBJECT</u>
34	SB OPT	1124-34-053	Navigation - Compass and ADF/RMI System Improvements
34	SB OPT	1124-34-052	Navigation - Glideslope Raw Data Scalloping
34	SB OPT	1124-34-049	Navigation - Radar Waveguide Pressurization and Installation of Silica Gel Container Assembly
34	SB OPT	1124-34-048 Rev. No. 1	Collins VNI-80 Vertical Navigation Indicator Operation Improvement
34	SB REC	1124-34-047 Rev. No. 1	Navigation - Static Source Improvement for Copilot's Altimeter
34	SB OPT	1124-34-044 Rev. No. 1	331A-9G HSI Distance Display Improvements
34	SB OPT	1124-34-039	Navigation FPA-80 Option Improvements
34	SB OPT	1124-34-027	Enable GNS-500A Series 3B Bank Command Option for Flight Director System
34	SB REC	1124-34-023	Navigation - Elimination of Improper Mach Warnings
34	SB OPT	1124-34-015 Rev. NO. 1	VOR/LOC Antenna Bonding and Phasing
35	SIL	1124-35-087	Oxygen - Eros Mc-Series Mask - Regulator Assembly Service Bulletin MA/B/C10-35-29
35	SIL	1124-35-083	Oxygen - Shutoff Valve Lubrication
35	SIL	1124-35-082	Oxygen-EROS MC-Series Mask-Regulator Assembly Overhaul Interval Increase
35	SIL	1124-35-035	Stowage of Eros Oxygen Mask P/N MC-1013-12
35	SIL	1124-35-015	Oxygen System - Time Unit Changes
35	SL	WW-24104	Installation of Surge Valve in Passenger Oxygen System
35	SB OPT	1124-35-077	Oxygen - Cabin Altitude Pressure Switch - Remote Test Connection Installation
39	SL	WW-2475	Installation of Diode in Flap Contactor Box
39	SL	WW-2468 Rev. No. 1	Inspection of Leach Relay Socket P/N S0-1059-8912

## SERVICE DATA CHAPTER INDEX

<u>CHP</u>	<u>TYPE</u>	<u>PUB NO.</u>	<u>SUBJECT</u>
39	SL	WW-2459	Replacement and Rework of Generator Start Contactor Bus Bars
39	SL	WW-2441	Insulation of Grounding Straps on Overhead Switch and Circuit Breaker Panel
39	SL	WW-2416	Increase Wire Loop at Base of Control Column
39	SB OPT	1124-39-011 Rev. No. 1	Overhead Panel Access and Alignment Improvement and/or Retrofit
51	SIL	1124-51-105	Structures - Inspection and Preventative Maintenance of Aircraft Structure for Corrosion at Antenna Mating Surfaces
52	SIL	1124-52-034	Prevention of Water Freezing in Cabin Doors and Baggage Doors
52	SL	WW-2498A	Installation of Life Raft Mooring Rings
52	SB OPT	1124-52-040	Doors - Door Handle Warning Switch Installation and Improved Door Wire Retract Tube Installation (AFC 2068)
52	SB OPT	1124-52-037 Rev. No. 1	FWD Baggage Door - Positive Hold-Open Provision
52	SB OPT	1124-52-019A	Improved Cabin Entrance Door-Stay
52	SB OPT	1124-52-007	Main Cabin Door Lower Flapper Retract Spring
52	SB OPT	1124-52-005	Doors - Improved Main Baggage Compartment Door Warning Switch Installation
53	SL	WW-2490	Installation of Water Barrier on Radar Bulkhead
53	SL	WW-2487	Modification of Jack Adapter (Located above Jack Position)
53	SL	WW-2435	Drilling of Drains Holes in Entrance Step Well
53	SB	WW-24-24 Rev. No. 2	Rework of Ballast/Jack Adapter Mounting
53	SB	WW-24-18 Rev. No. 1	Installation of Bolts in Floor, Near Fus. STA 269
53	SB	WW-24-16	Aft Pressure Bulkhead Modification
53	SB REC	1124-53-123	Fuselage - Drainage Under Cabin Deck

SERVICE DATA CHAPTER INDEX

<u>CHP</u>	<u>TYPE</u>	<u>PUB NO.</u>	<u>SUBJECT</u>
53	SB OPT	1124-53-118	Fuselage - Frame Reinforcement Repair Installation
53	SB REC	1124-53-114	Fuselage - Floor Panel Insulation Removal
53	SB OPT	1124-53-102	Fuselage - Drain Valves Installation in the Fuselage Lower Skin (AFC 2076)
53	SB REC	1124-53-101	Fuselage - Enlarge Existing Wing Attachment Access Holes in the Aft Pressure Bulkhead at Fuselage Station 269.879 for Structural Inspection (AFC 2075)
53	SB OPT	1124-53-068	Doors - Nose Gear Trunnion Access Door Installation
53	SB OPT	1124-53-026	Closure of Tail Cone Vent Holes
54	SL	WW-24110	Aft Cowl Second Ignitor Outer and Inner Access Door Fastener Improvement
54	SL	WW-2450B	Nacelle Inlet Cowl Inspection/Repair
54	SL	WW-2438 Rev. No. 1	Nacelle Upper Cowl Door Latch Inspection
54	SL	WW-2437	Doubler Installation - Pylon Firewall
54	SL	WW-2408	Modification to Generator Cables Support Bracket on L. H. Engine
54	SB OPT	1124-54-112	Nacelles - Cowl Door Corrosion - Inspection, Prevention and Repair
55	SB OPT	1124-55-124	Stabilizers - Horizontal Stabilizer Upper Scissor Fitting Replacement (AFC 2097)
55	SB REC	1124-55-107	Stabilizers - Horizontal Stabilizer Lower Scissor Fitting Replacement (AFC 2073)
55	SB REC	1124-55-097	Horizontal Stabilizer Scissors Assembly P/N 453516-501 or -503 Inspection
55	SB REC	1124-55-021 Rev. No. 3	Horizontal Stabilizer Assembly - Inspection, Repair and Improvement (AFC 2037)
55	SB REC	1124-55-020 Rev. No. 2	Horizontal Stabilizer Aft Spar Splice Fitting P/N 453005-501 (Hinge Assembly) Inspection
56	SIL	1124-56-081	Windows-Cockpit Side Windows
56	SIL	1124-56-029 Rev. No. 1	Cockpit Side Windows - Improved Removal/Installation Procedures

SERVICE DATA CHAPTER INDEX

<u>CHP</u>	<u>TYPE</u>	<u>PUB NO.</u>	<u>SUBJECT</u>
56	SL	WW-2440	Cabin Window Shade Improvement
56	SB OPT	1124-56-113	Windows - Improved Cockpit Side Window Installation
56	SB OPT	1124-56-042A	Windows - Repair of the Inner Windshield Panel
57	SIL	29	Wing Root Lower Access Panel Attachment Check
57	SL	WW-2469 Rev. No. 1	Rework or Replacement of Flap Deflectors P/N 5163009-23 and -24
57	SB	WW-24-17A Rev. No. 1	Installation of Additional Rivets in 25 Percent Wing Spar
57	SB REC	1124-57-126	Wings - Leading Edge Extension Drains
57	SB REC	1124-57-092 Rev. No. 1	Wings - Flap Hinge Fasteners - Inspection/Replacement
57	SB REC	1124-57-004 Rev. No. 1	Drain Holes in Wing Trailing Edge Structure
71	SIL	02	High Pressure Bleed Port Gasket
71	SIL	1124-71-071	Exhaust - Engine Tail Pipe Clamp - Torque Check
71	SL	WW-2476 Rev. No. 1	Replacement of Grumman Engine Inlet Anti-Ice Shutoff Valves Part Number F10A-5-SCP102-5 Effective the Following Serial Numbers: 0010695 thru 0010734; 0030735 thru 0030784; 0050785 thru 0050849
71	SL	WW-2470A	Installation of Aft Mount Auxiliary Bracket per Garrett Service Bulletin No. TFE 731-72-3159
71	SB	WW-24-21	One Time Inspection of Forward Engine Mount Attaching Bolts for Sufficient Torque
71	SB	WW-24-8A	Replacement of Nuts and Washers on Forward Engine Mount Attachment Bolts
71	SB	WW-24-7A	Aft Engine Mount Fitting Assembly Inspection
71	SB MAN	1124-71-091 Rev. No. 2	Power Plant - Forward Engine Mount Fasteners - Inspection/Replacement (AFC 2065)
73	SIL	1124-73-018 Rev. No. 1	Engine Fuel Computer EMI Filter Inspection

SERVICE DATA CHAPTER INDEX

<u>CHP</u>	<u>TYPE</u>	<u>PUB NO.</u>	<u>SUBJECT</u>
73	SL	WW-24102	Improved Fuel Control Computer Relay P/N MS27743-6
76	SIL	1124-76-024	Identification of Throttle Quadrant Limit Switch Assignments
77	SL	WW-2462 Rev. No. 1	Improved G. E. ITT Indicator P/N 6883621-503
78	SIL	38	Inspection and Service Life on Gas Storage Bottles P/N 3753015 and 3753015-501
78	SIL	1124-78-092	Thrust Reverse - Replacement of Thrust Reverse Fault Test Switch
78	SL	WW-24109	Thrust Reverser Stang Cover Fastener Improvement
78	SL	WW-2443	Installation of Button Caps on T/R Power Circuit Breakers
78	SL	WW-2433	Replacement of Thrust Reverser Pivot Bushings and Secondary Door Latch
78	SL	WW-2419	Thrust Reverser Arming Activation
78	SL	WW-2404 Rev. No. 1	Clamping of Thrust Reverser Wiring
78	SL	WW-2401 Rev. No. 1	Inspection Hole in T/R Doors
78	SB	WW-24-13	Replacement of Throttle Retarder Feedback Control
78	SB	WW-24-2	Bolts Replacement on Thrust Reverser Controls Installation
78	SB OPT	1124-78-111	Exhaust - Thrust Reverser Fault Test Switch Reliability Improvement (AFC 2084)
79	SB REC	1124-79-093	Oil - Engine - Oil Pressure Indication Installation (AFC 2066)
80	SIL	33	Engine Cross Start
80	SIL	16	Lear Siegler Starter/Generator Brush Inspection
80	SL	WW-2432	Installation of Lear Siegler Starter-Generator P/N 23065-018-1 per IAII STC #SA2858SW
80	SL	WW-2407	Starter Generator Ground Attachment Inspection



SERVICE DATA CHAPTER INDEX

<u>CHP</u>	<u>TYPE</u>	<u>PUB NO.</u>	<u>SUBJECT</u>
80	SL	WW-2406 Rev. No. 1	50 Hour Inspection of General Electric Model 2CM504D2D Starter-Generator's Brushes and Commutators
80	SB	WW-24-3 Rev. No. 1	Installation of Frame Block for External Ground to Starter-Generator

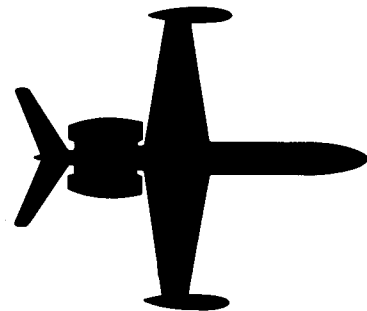

# SERVICE INFORMATION LETTER

## SERVICE INFORMATION LETTER INDEX

<u>NO.</u>	<u>DATE</u>	<u>SUBJECT</u>
1124-21-001	Mar 15/84	Pressurization - Deletion of Adjustment for Fluid Pressure Regulator Valve
1124-27-002	Nov 9/84	Flap Asymmetry Comparator Control Box Failures and Nuisance Flap Imbalance Warnings
1124-30-003	Nov 19/84	Pitot and AOA Heat Limitations
1124-22-004	Dec 3/84	Pilot and Copilot Annunciator Panel Interconnect Plug Wiring
1124-24-005 Rev. No. 1	Jun 20/85	Inspection and Test of Priority Bus Diodes
1124-24-006	Dec 11/84	Alternate Part for Engine Pylon Firewall Bulkhead Connectors J313 and J314
1124-21-007 Rev. No. 1	Aug 9/85	Adjustment Procedures for the 3213894-1-1 Bleed Switching Valve
1124-33-008	Dec 18/84	Staco Switch and Lamp Assemblies
1124-28-009	Dec 13/84	Wing Fuel Probe Gasket, Left and Right Outboard
1124-25-010	Dec 18/84	Passenger Seat Recline Control Removal/Installation Improvement
1124-22-011 Rev. No. 1	Feb 17/86	Air Data/Computer and Altimeter Certification for 1124A
1124-34-012 Rev. No. 1	Apr 5/85	Coaxial Cable Clamping

## SERVICE INFORMATION LETTER INDEX

<u>NO.</u>	<u>DATE</u>	<u>SUBJECT</u>
1124-21-013	Feb 6/85	Approved Alternate Lubricants for Airesearch Cooling Turbine 572375-1-2 and -3
1124-21-014	Feb 8/85	Pressurization - Maintenance of Outflow Valves
1124-35-015	Feb 11/85	Oxygen System - Time Unit Changes
1124-23-016	Jan 28/85	Static Wick and Base Bonding Tests
1124-21-017	Feb 12/85	Cooling Turbine - Oil Sump Drain Plug Accessibility Improvement
1124-73-018 Rev. No. 1	Jun 14/85	Engine Fuel Computer EMI Filter Inspection
1124-24-019B	Nov 14/86	Distribution Bus Circuit Breaker Inspection
1124-28-020A	Apr 30/87	Fuel - Dump Valve Interchangeability
1124-34-021	Feb 19/85	Installation of Chafe-Guard Material on Wire Bundles at Station 269 Near Emergency Gyro Power Supply
1124-32-022	Mar 20/85	Steering Yoke - Grease Fitting Replacement
1124-24-023	Feb 25/85	Minimizing Precipitation Static Interference through Proper Aircraft Bonding
1124-76-024	Feb 26/85	Identification of Throttle Quadrant Limit Switch Assignments
1124-33-025 Rev. No. 1	Sep 9/85	Failure of Aircraft System and Lamp Test Function
1124-28-026	Mar 11/85	Replacement of Firewall Fuel Shut-Off Valve Light Circuit Relay
1124-25-027	Mar 20/85	Improved Stereo Speaker Clarity
1124-27-028 Rev. No. 1	CANCELED May 29/90	Flap Limit Switch Replacement
1124-56-029 Rev. No. 1	CANCELED May 2/89	Cockpit Side Windows - Improved Removal/Installation Procedures

SERVICE INFORMATION LETTER INDEX

<u>NO.</u>	<u>DATE</u>	<u>SUBJECT</u>
1124-27-030 Rev. No. 1	CANCELED May 29/90	Measurement Limits of Aileron Trim and Servo Tab Free Play
1124-34-031A Rev. No. 1	Apr 29/85	Pilot and Copilot Annunciator Panel Cable Bundle Chafing/Shorting
1124-33-032	Jul 8/88	Lighting - Cockpit Glareshield - Floodlight Improvement
1124-32-033	Mar 20/85	Main/Nose Landing Gear - Revised Limit Switch Adjustments
1124-52-034	Apr 24/85	Prevention of Water Freezing in Cabin Doors and Baggage Doors
1124-35-035	Mar 20/85	Stowage of Eros Oxygen Mask P/N MC-1013-12
1124-34-036	Mar 20/85	AOA System - Component Replacement
1124-24-037	Mar 21/85	Storage of Nickel Cadmium Aircraft Batteries
1124-22-038	Apr 2/85	Vertical Gyro Adjustment Procedure
1124-22-039	Apr 2/85	Vertical Gyro Improvements
1124-34-040	Apr 2/85	Radar Stabilization Improvements
1124-32-041	Apr 2/85	Goodyear Nose Gear Bearing Seals
1124-22-042	Apr 2/85	Horizontal Trim Actuator Response Time
1124-21-043	Apr 2/85	Improved Gaskets for Bleed Switching Valve
1124-23-044	Apr 2/85	To Prevent Failure of Stereo System and "L" Pad Cabin Volume Controls
1124-22-045B	Feb 7/86	Six-Pole Relay Contact Failures and Replacement Information
1124-34-046	Apr 5/85	NCS31/A Slant Range Correction
1124-23-047	Apr 8/85	Collins HF220 System Improvements
1124-23-048	Apr 8/85	Aircraft Microphones and COM Unit Adjustment
1124-23-049 Rev. No. 1	Jul 31/85	CTL 20/30 COM/NAV Control Interchangeability

SERVICE INFORMATION LETTER INDEX

<u>NO.</u>	<u>DATE</u>	<u>SUBJECT</u>
1124-34-050	May 27/85	HSI-84/REU-84 Modification/Status Changes
1124-29-051	May 27/85	Hydraulic Power - Emergency Hydraulic Pump Shaft Seal Drain Fitting - Proper Installation Instructions
1124-34-052 Rev. No. 1	Jul 5/85	NCS/FMS Electro-Magnetic Interference Problems
1124-34-053	Aug 9/85	FMS-90/LRN-85/GNS-500 Backlighting
1124-24-054	Jun 5/85	AC Static Inverter Improvements
1124-25-055	Jun 14/85	Sherwood Toilet P/N 2051 Timer Failures
1124-22-056	Aug 12/85	Inadvertent Annunciator Lamp Control
1124-27-057	Sep 16/85	Rudder and Tabs - Synchronization of Dual Actuators
1124-33-058	Sep 27/85	Electrical Noise Radiation from Cabin Fluorescent Lighting System
1124-25-059 Rev. No. 1	Jul 31/89	Portable Fire Extinguishers
1124-23-060	Jan 10/86	Communications - Audio - Sidetone Adjustment Procedures
1124-12-061	Jan 30/86	Servicing - Over Wing Refueling Ports
1124-28-062	Feb 7/86	To Announce the Availability of a New Fuel Vent Valve
1124-27-063	Feb 7/86	To Announce the Availability of a New EMI Filter
1124-27-064	Feb 7/86	Horizontal Trim Actuator - Axial Play
1124-22-065A	Oct 31/86	Autopilot - To Reduce Roll Axis Cycling
1124-21-066 Rev. No. 3	Oct 28/92	Air Conditioning - Improved Bleed Switching Valve (Garrett P/N 3213894-4-1)
1124-29-067	Oct 31/86	Hydraulic Power - Suggested Inspection Methods for Aft Fuselage (Station 316) Hydraulic Lines
1124-22-068	Nov 7/86	Autopilot - To Reduce Roll Axis Cycling and Improve Vertical Mode Performance

SERVICE INFORMATION LETTER INDEX

<u>NO.</u>	<u>DATE</u>	<u>SUBJECT</u>
1124-21-069	Jan 16/87	Air Conditioning - Improved Bleed Switching Valve Body Seals
1124-27-070	May 31/89	Flight Controls - Suggested Specialty Tooling for Control System Free Play Measurement
1124-71-071	Apr 4/88	Exhaust - Engine Tail Pipe Clamp - Torque Check
1124-20-072	May 31/89	Service Bulletin - Compliance Designations
1124-34-073 Rev. No. 1	May 29/90	Weather Radar - Collins IND-300 Weather Radar Indicator Mandatory Service Bulletin
1124-29-074	Sep 8/89	Hydraulic - Approved Use of Teflon Back-Up O-Rings
1124-22-075	Dec 7/89	Auto Pilot - Vertical Gyro Precession
1124-22-076	Mar 26/90	Auto Pilot-Altitude Preselect Errors
1124-09-077	Jun 15/90	Towing and Taxiing - Proper Towing Procedures
1124-21-078 Rev. No. 1	Mar 20/91	Air Conditioning - 35 Degree Temp Sensor Connector - Reliability Improvements
1124-05-079 Rev. No. 2	Nov 18/92	Time Limits/Maintenance Checks-50 Hour Phase Inspection
1124-30-080	May 29/90	Ice and Rain Protection - Engine HP Bleed Manifold Assembly
1124-56-081	Jun 15/90	Windows-Cockpit Side Windows
1124-35-082	Aug 8/90	Oxygen-EROS MC-Series Mask-Regulator Assembly Overhaul Interval Increase
1124-35-083	Oct 1/90	Oxygen - Shutoff Valve Lubrication
1124-33-084	Dec 12/90	Lighting - Tip Tank Strobe Light Wiring
1124-21-085	Dec 27/90	Air Conditioning - 35°F Temperature Control Sensor Installation
1124-34-086 Rev. No. 1	Apr 4/91	Navigation - Weather Radar Antenna

SERVICE INFORMATION LETTER INDEX

<u>NO.</u>	<u>DATE</u>	<u>SUBJECT</u>
1124-35-087	Mar 13/91	Oxygen - Eros MC-Series Mask - Regulator Assembly Service Bulletin MA/B/C10-35-29
1124-05-088	Apr 24/91	Time Limits/Maintenance Checks - Structural Inspection Program
1124-32-089	Mar 13/91	Landing Gear - MLG Tire Shoulder Cracks
1124-28-090	Mar 13/91	Fuel - Fuel Dump Stop Level Switch Precautions
1124-24-091	Jul 17/91	Electrical - Lucas Aerospace (Lear Siegler) Starter Generator Bearing Replacement
1124-78-092	Oct 9/91	Thrust Reverse - Replacement of Thrust Reverse Fault Test Switch
1124-31-093	Feb 26/92	Indicating - Recording Systems - Cockpit Voice Recorder Underwater Acoustic Beacon Field Maintenance
1124-11-094	Apr 15/92	Placards - Protection From Skydrol Damage
1124-25-095	Apr 15/92	Equipment/Furnishings - Monogram Series 15500 Toilet Maintenance
1124-25-096	Jul 1/92	Equipment/Furnishings - Extended Over Water Operations, Safety and Survival Equipment
1124-05-097	Jul 29/92	Time Limits/Maintenance Checks - Pressure Cylinders Hydrostatic Test Interval Revisions
1124-32-098	Aug 12/92	Landing Gear - Nose Wheel Bolt Hole Repair
1124-33-099	Jul 14/93	Lights - Cabin Fluorescent Support System Parts Upgrade/Replacement
1124-32-100	Sep 1/93	Landing Gear - Wheel Inspection and Overhaul Schedules
R 1124-33-101	Nov 10/93	Lighting - Alternate Cockpit Map Light

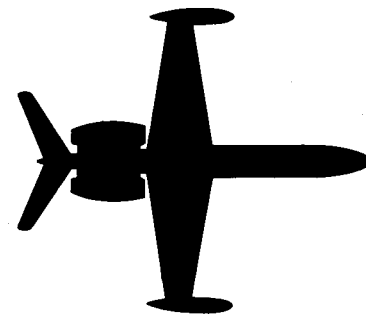

# SERVICE INFORMATION LETTER

SIL NO. 1124-05-079

REVISION 2

November 18, 1992

## TRANSMITTAL SHEET

This sheet transmits Revision 2 to Service Information Letter No. 1124-05-079 dated May 21, 1990, titled "Time Limits/Maintenance Checks - 50 Hour Phase Inspection".

### REASON FOR REVISION

To advise operators and maintenance facilities that Revision No. 7 to the 50 Hour Phase Inspection is available.

This is a COMPLETE REVISION. Please remove and discard all pages of previous issues and replace with the pages of this revision.

### LIST OF EFFECTIVE PAGES

<u>PAGE NO.</u>	<u>DATE</u>
1	November 18, 1992

### PREVIOUS REVISIONS OF SIL 1124-05-079

Revision No. 1	May 29, 1991
----------------	--------------



# **24-WESTWIND**

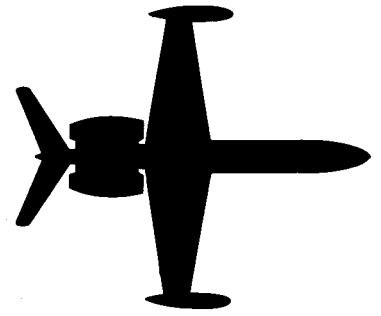

## **SERVICE INFORMATION LETTER**

---

---

**SIL NO.** 1124-05-079

May 29, 1990

**SUBJECT:** TIME LIMITS/MAINTENANCE CHECKS - 50 HOUR PHASE  
INSPECTION

**EFFECTIVITY:** MODEL 1124 AND 1124A WESTWIND, all serial numbers.

**A. REASON**

To advise operators and maintenance facilities that Revision No. 7 to the 50 Hour Phase Inspection has been issued.

**B. REFERENCE**

1124/1124A Westwind Maintenance Manual, Chapter 5-10-00 through 5-30-00.  
1124/1124A Westwind Maintenance Manual, Temporary Revision No. 5-6.

**C. PUBLICATIONS AFFECTED**

50 Hour Phase Inspection.

**D. DESCRIPTION**

The 50 Hour Phase Inspection has been revised to Revision No. 7. This revision incorporates 1124/1124A Westwind Maintenance Manual, Temporary Revision No. 5-6 into the 50 Hour Phase Inspection Program.

One copy of Revision No. 7 to the 50 Hour Phase Inspection is available to each current Service Data Book subscriber at no charge. To receive your copy, please call Astra Jet Corporation, Technical Publications, 302-324-5150.

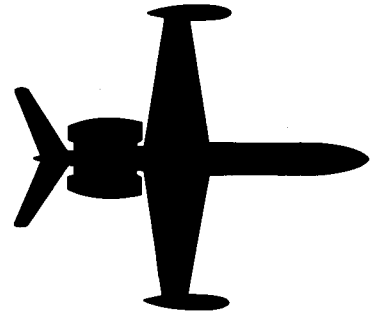

# **SERVICE INFORMATION LETTER**

---

**SERVICE INFORMATION LETTER NO. 1124-05-088**

**April 24, 1991**

**SUBJECT: TIME LIMITS - MAINTENANCE CHECKS - STRUCTURAL  
INSPECTION PROGRAM**

**EFFECTIVITY: Model 1124/1124A WESTWINDS, all serial numbers.**

**A. REASON**

To emphasize that it is **MANDATORY** to comply with the Structural Inspection Program, Section 5-40-00 through 5-40-05 of the 1124/1124A Westwind Maintenance Manual.

**B. REFERENCE**

1124/1124A Westwind Maintenance Manual, Chapter 5-40-00 through 5-40-05.  
Nondestructive Testing Manual.

Federal Aviation Regulation (FAR) Part 91, Sub Part D (Current Revision).  
Civil Aviation Administration of Israel, Airworthiness Directive No. 91-01.

**C. PUBLICATIONS AFFECTED**

**NONE**

**D. DESCRIPTION**

This SIL is issued to emphasize that to be in compliance with current Federal Aviation Regulation (FAR) Part 91, Sub Part D, it is **MANDATORY** to comply with the Structural Inspection Program, Section 5-40-00 through 5-40-05 of the 1124/1124A Maintenance Manual at intervals specified therein. The Structural Inspection Program is also referred to in the General section of the 1124/1124A 50 Hour Phase Inspection Program.

April 24, 1991

677

SIL 1124-05-088

Page 1 of 2

**SERVICE INFORMATION LETTER NO. 1124-05-088**

**Inspection of aircraft structure must be done in accordance with the Nondestructive Testing Manual, at intervals specified in the Structural Inspection Program.**

**Aircraft registered in countries other than the United States are advised that the Civil Aviation Administration of Israel has issued an Airworthiness Directive, No. 91-01, dated March 11, 1991, mandating compliance of the Structural Inspection Program.**

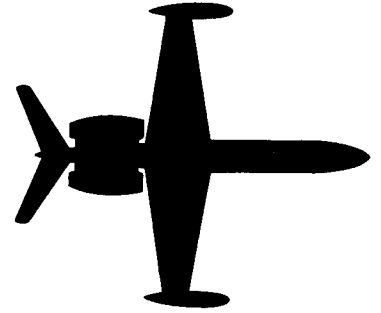

# SERVICE INFORMATION LETTER

SERVICE INFORMATION LETTER NO. 1124-05-097

July 29, 1992

**SUBJECT:** TIME LIMITS/MAINTENANCE CHECKS - PRESSURE  
CYLINDERS HYDROSTATIC TEST INTERVAL REVISIONS

**EFFECTIVITY:** MODEL 1124/1124A WESTWIND, all serial numbers.

**A. REASON**

To announce revisions to pressure cylinders hydrostatic test intervals.

**B. REFERENCE**

1124/1124A Westwind Maintenance Manual, Chapter 5-10-00.  
Federal Aviation Administration Order 8000.40C.

**C. PUBLICATIONS AFFECTED**

1124/1124A Westwind Maintenance Manual, Chapter 5-10-00.

**D. DESCRIPTION**

The Federal Aviation Administration has issued FAA Order 8000.40C addressing "Maintenance of pressure cylinders in use as aircraft equipment." Previously, it was permissible to leave a pressurized container in service past its hydrostatic test date, provided there was no visible damage and it was properly charged. According to this FAA Order, 8000.40C, "pressure cylinders used as aircraft equipment may no longer remain in service beyond their hydrostatic test date, regardless of the state of charge of the cylinder."

Effective immediately, compliance of hydrostatic testing of pressure cylinders shall be as follows:

(1) Fire Extinguisher Containers.

- (a) For containers last hydrostatic tested before July 29, 1988, containers are due hydrostatic test before July 29, 1993.

SERVICE INFORMATION LETTER NO. 1124-05-097

- (b) For containers last hydrostatic tested after July 29, 1988, containers are due hydrostatic test at five (5) years.
- (2) Gas Storage Cylinder (Emergency Gear Down and Thrust Reverser).
  - (a) For cylinders last hydrostatic tested before July 29, 1990, cylinders are due hydrostatic test before July 29, 1993.
  - (b) For cylinders last hydrostatic tested after July 29, 1990, cylinders are due hydrostatic test at three (3) years.

A revision to the 1124/1124A Westwind Maintenance Manual, Chapter 5-10-00, with these changes, has been issued.

# **1124-WESTWIND**

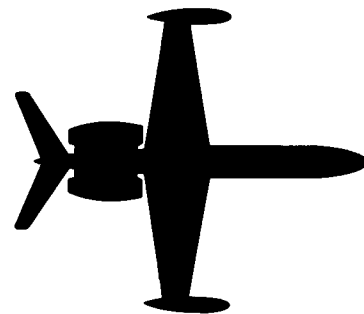

## **SERVICE INFORMATION LETTER**

**SERVICE INFORMATION LETTER NO. 1124-09-077**

**June 15, 1990**

**SUBJECT: TOWING AND TAXIING - PROPER TOWING PROCEDURES**

**EFFECTIVITY: MODEL 1124 AND 1124A WESTWINDS, all serial numbers.**

### **A. REASON**

Recently an 1124A Westwind II was required to perform a nose gear up landing due to damaged nose gear steering brackets preventing extension of the nose gear. It is suspected that the damage resulted from improper ground handling procedures. This SIL is issued to emphasize the need to adhere to, and to repeat the instructions for proper towing procedures.

### **B. REFERENCE**

FAA General Aviation Airworthiness Alerts (AC No. 43-16) No. 142, May 1990.  
1124/1124A Westwind Maintenance Manual, Chapters 9-10-00 and 11-20-00.

### **C. PUBLICATIONS AFFECTED**

1124/1124A Westwind Maintenance Manual, Chapters 9-10-00 and 11-20-00.

### **D. DESCRIPTION**

**WARNING: DAMAGE TO NOSE LANDING GEAR AND/OR STEERING LINKAGE CAN RESULT FROM TOWING AIRCRAFT WITH NOSE SCISSOR CONNECTED. NOSE LANDING GEAR SCISSOR MUST ALWAYS BE DISCONNECTED DURING TOWING OPERATIONS. SCISSOR MUST BE RECONNECTED PRIOR TO FLIGHT OPERATIONS.**

To prevent damage to the nose landing gear and steering linkage, personnel involved in towing operations of Westwind aircraft are encouraged to:

1. Review the towing procedures in the 1124/1124A Westwind Maintenance Manual [reference attached pages 1 through 4 (9-10-00)].
2. Inspect placards installed on nose gear door, reference Figure 1 below, for existence, condition and legibility. Missing or deteriorated placards should be replaced.

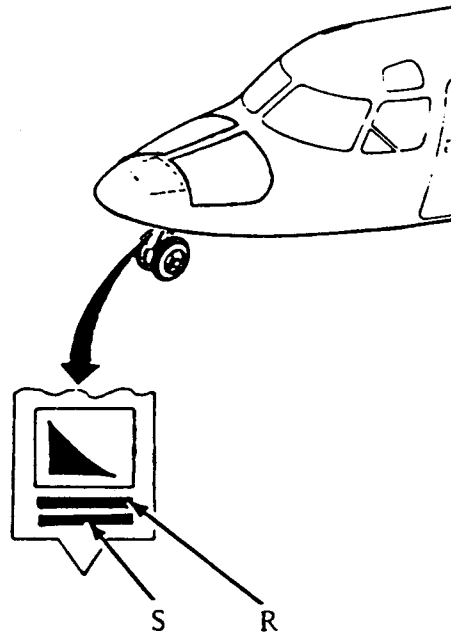

## WARNING

SCISSOR ASSY MUST BE CONNECTED  
AT ALL TIMES WHEN OPERATING AIRCRAFT

DETAIL R

SCISSOR PIN MUST BE DISCONNECTED,  
WITH 6.80 INCHES OR MORE STRUT  
EXTENSION, WHEN TOWING AIRCRAFT BY  
TOW BAR.

DETAIL S

**FIGURE 1**

R 1. General

R A. Towing the aircraft over hard, flat surfaces is accomplished at the  
R nose gear for normal maintenance and ramp functions.

R B. When the aircraft has left a hard, flat surface runway and has  
R become mired in soft sand, mud or snow, the aircraft must be towed  
R aft from the main gears. The nose gear tow bar should be used only  
R for steering while the aircraft is being towed.

R C. Provision is made on the nose gear for attaching a tow bar  
R (P/N 5753517) for towing and pushing the aircraft either by hand or  
R with a towing vehicle.

R NOTE: The tow bar is standard issue and must be carried aboard the  
R aircraft at all times. If tow bar is removed from the  
R storage placed on aircraft, its weight must be subtracted  
R from basic operating weight.

R 2. Towing (See Figure 1)

R A. Nose Gear Turning Angle

R A stripe is painted on the lower side of the radome, indicating  
R that the maximum turning angle is:  
R - 45° left or right for aircraft 152, 154, 174, 181, 185-353, 360  
R - 58° left or right for aircraft 354-359, 361 and Subs

R CAUTION: THE NOSE LANDING GEAR CAN BE DAMAGED IF THE TURN LIMITS  
R ARE EXCEEDED WITH THE SCISSORS CONNECTED OR WHEN THE  
R SCISSORS ARE DISCONNECTED AND THE TOP SCISSOR IS BETWEEN  
R THE NOSE TIRES DUE TO FUEL LOAD OR STRUT SERVICE.

R NOTE: The nose wheel can be turned 360° when the scissors are  
R disconnected.

R B. Towing Conditions

R Before towing, by hand or with a towing vehicle, perform the  
R following:

R (1) Station a qualified person in pilot's seat.

R (2) Disengage the nose gear scissors by removing the (pip-pin)  
R quick-release pin. Raise the upper torque link and secure in  
R the up position bracket with the pip-pin.

EFFECTIVITY: ALL

**9-10-00**

Page 1  
Dec 15/84



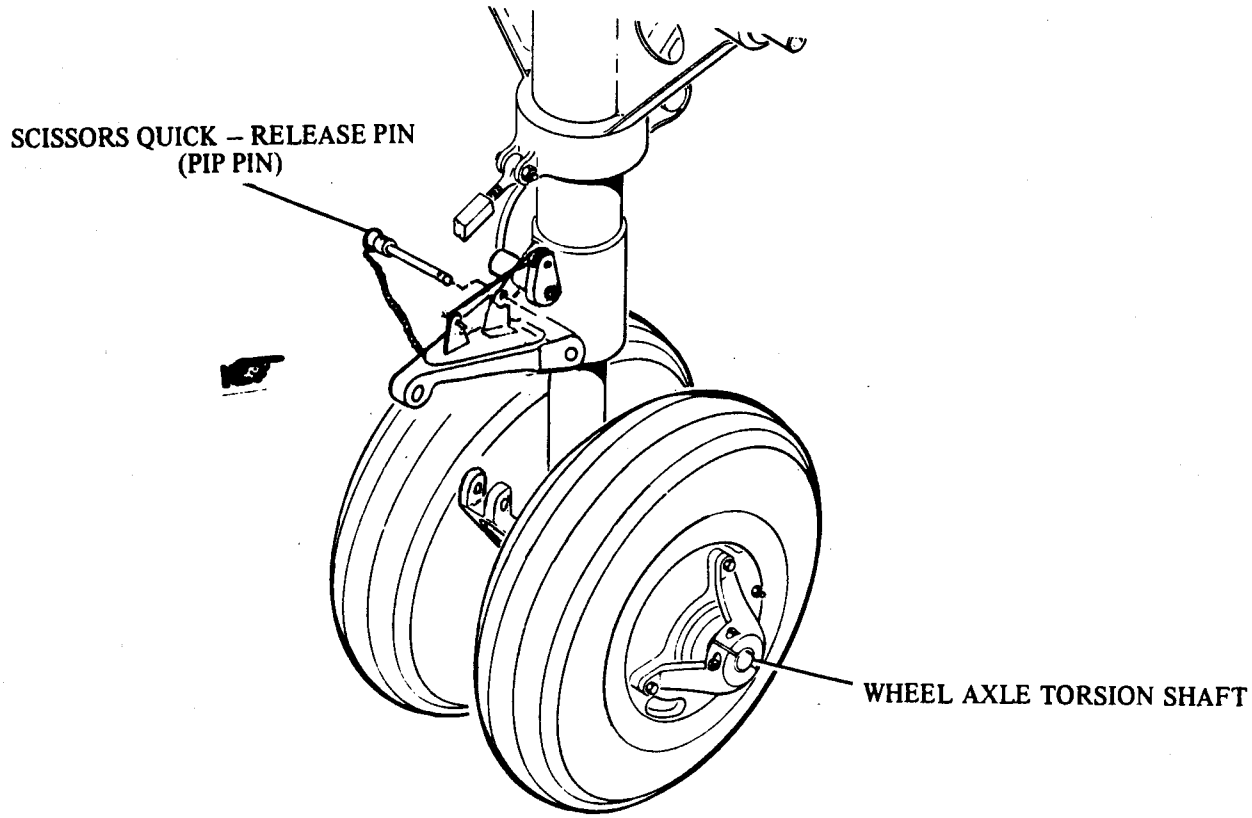
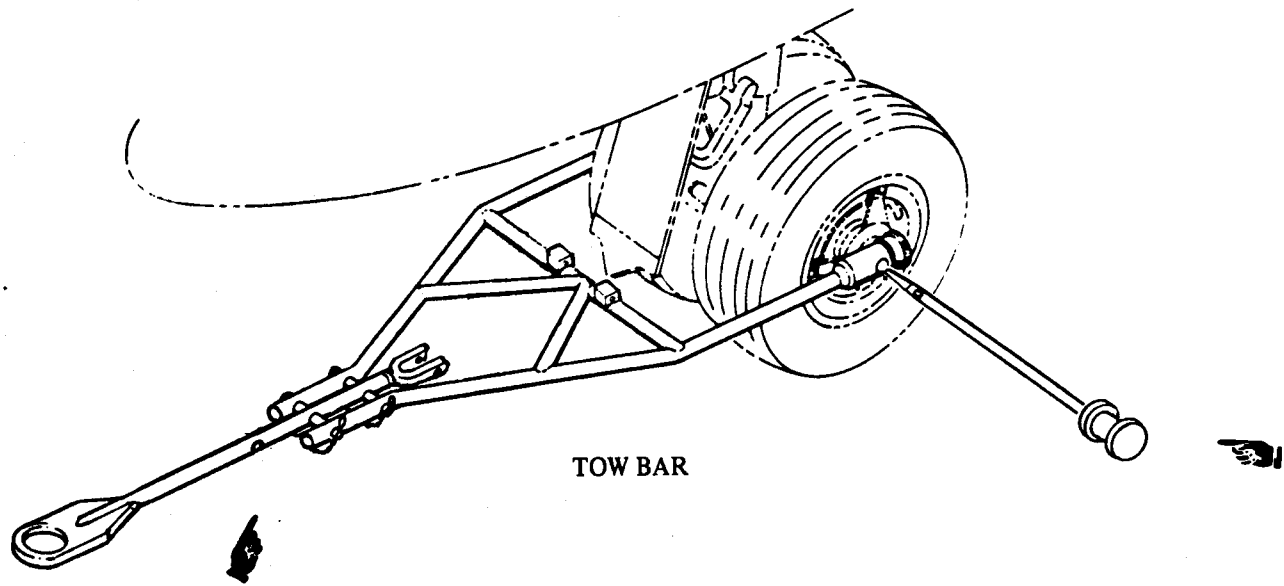

Towing and Tow Bar Installation  
Figure 1 (Sheet 1 of 2)

EFFECTIVITY: ALL

**9-10-00**

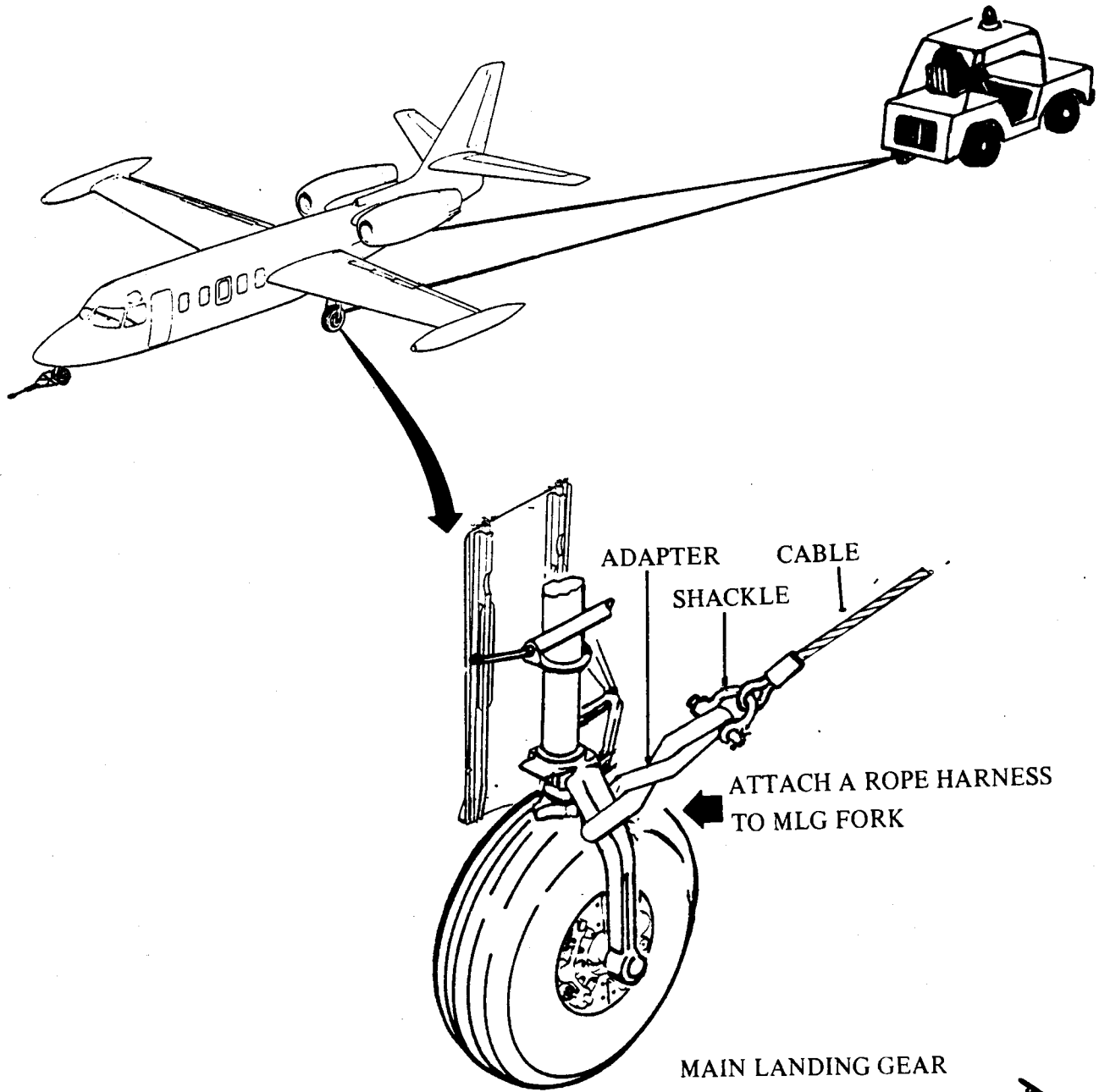

Towing and Tow Bar Installation  
Figure 1 (Sheet 2 of 2)

EFFECTIVITY: ALL

9-10-00

Page 3  
Dec 15/84

- R (3) Attach tow bar to the nose wheel axle torsion shaft.
- R (4) Ensure that there is sufficient hydraulic pressure available  
R to be able to apply the aircraft brakes.
- R (5) Ensure that all doors of the aircraft and towing vehicle are  
R secured.
- R (6) Ensure that wheel chocks, static ground cables and mooring  
R cables are removed.

R C. Nose Gear Towing

- R (1) Prepare aircraft for towing in accordance with par. 2B steps  
R (1) through (6).
- R (2) Connect tow bar to towing vehicle.
- R (3) Release parking brake.
- R (4) In congested areas, station wing walkers to check clearance  
R between aircraft and adjacent equipment.
- R (5) Tow aircraft, making smooth starts and stops with towing  
R vehicle.

R CAUTION: WHEN REPOSITIONING AIRCRAFT ALL PERSONNEL SHALL  
R WATCH FOR CLEARANCES OR OBSTRUCTIONS AND HAVE TWO  
R CHOCKS AVAILABLE TO CHOCK MAIN WHEELS IF AN  
R EMERGENCY SHOULD OCCUR AND PARKING BRAKE CANNOT BE  
R APPLIED.

- R (6) When towing operation is completed, turn nose wheel to center,  
R chock wheels and connect static ground cables.
- R (7) Reconnect nose landing gear scissors.
- R (8) Remove tow bar from nose wheel axle.

R D. Main Gear Towing

R When moving the aircraft over soft sand, muddy ground or snow and  
R for extracting the aircraft from mud, tow aircraft aft by attaching  
R a rope harness to the lower portion of the main landing gear  
R struts. Use the tow bar to steer the aircraft.

EFFECTIVITY: ALL

**9-10-00**

# 1124-WESTWIND

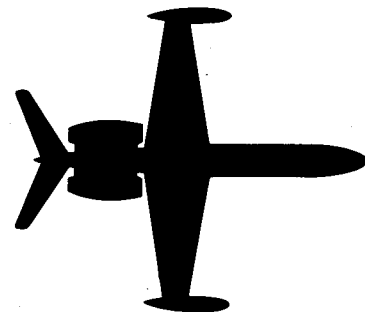

## SERVICE INFORMATION LETTER

---

---

SIL NO. 1124-12-061

January 30, 1986

SUBJECT: SERVICING - OVER WING REFUELING PORTS

EFFECTIVITY: Model 1124/1124A Westwinds, all serial numbers

A. REASON

Some service personnel have reported difficulty securing the fuel cap after over wing refueling operation.

B. REFERENCES

1124/1124A Maintenance Manual, Chapters 12 and 28.

C. PUBLICATIONS AFFECTED

Not Applicable

D. DESCRIPTION

The following procedure is recommended to avoid encountering difficulty while attempting to close the over wing fuel cap.

- (1) Push the cap by hand against spring tension, to the fully closed position insuring that the cap is fully seated and hold in this position.
- (2) Insert common screwdriver into Dzus Fastener and push against spring tension, approximately 3/4 of the way in.
- (3) While pushing on Dzus and holding cap by hand, turn clockwise until Dzus is locked.



SUBSIDIARY OF ISRAEL AIRCRAFT INDUSTRIES, LTD.  
BEN GURION AIRPORT, ISRAEL

SIL 1124-12-061  
Page 1 of 1

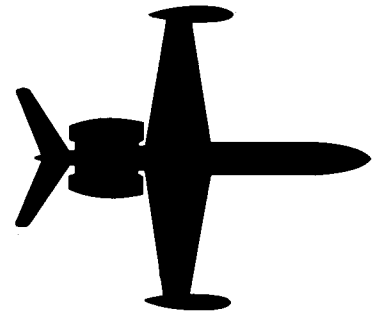

# SERVICE INFORMATION LETTER

---

SERVICE INFORMATION LETTER NO. 1124-20-072

May 31, 1989

SUBJECT: SERVICE BULLETIN - COMPLIANCE DESIGNATIONS

EFFECTIVITY: MODEL 1124/1124 Westwind, all serial numbers

A. REASON

To introduce a new "MANDATORY" compliance designation and define all the compliance designations.

B. REFERENCE

None.

C. PUBLICATION AFFECTED

Service bulletins as deemed necessary.

D. DESCRIPTION

Service bulletins will now have one of the three following compliance designations:

OPTIONAL

The "Optional" category indicates that implementation of the service bulletin is at the discretion of the user.

The "Optional" category is used for modifications which some users may not need or benefit from. However, the modification is still considered an improvement for the affected aircraft.



SUBSIDIARY OF ISRAEL AIRCRAFT INDUSTRIES, LTD.  
BEN GURION AIRPORT, ISRAEL

SIL 1124-20-072  
Page 1 of 2

SERVICE INFORMATION LETTER 1124-20-072

RECOMMENDED

The "Recommended" category indicates that all users of affected aircraft should implement the service bulletin at their earliest convenience.

The "Recommended" category is used to improve operation of the affected aircraft.

MANDATORY

The "Mandatory" category indicates that all aircraft of affected type and S/N are urged to comply. A period or date for compliance is included.

The "Mandatory" category is used when IAI assesses that compliance is essential to meet desired reliability, maintenance or performance design criteria of the aircraft.

All registered owners of affected aircraft will be notified of the existence, reason for, availability, and compliance instructions of a "Mandatory" service bulletin.

The FAA considers a service bulletin to be mandatory based on the following criteria:

- 1 - service bulletins listed in the Type certificate Data Sheet
- 2 - service bulletins referenced in AD notes
- 3 - inspection in accordance with a service bulletin if it is listed in the inspection program as required by FAR 91.169

Unless a service bulletin comes under these criteria, an operator is not obligated to accomplish it, even if it is designated as Mandatory. No manufacturer can mandate compliance.

# **114-24-WESTWIND**

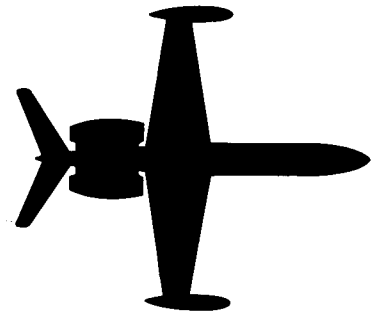

## **SERVICE INFORMATION LETTER**

---

**SERVICE INFORMATION LETTER NO. 1124-20-102**

**April 6, 1994**

**SUBJECT: STANDARD PRACTICES - AIRWORTHINESS OF PARTS**

**EFFECTIVITY: MODEL 1124 & 1124A WESTWIND, all serial numbers.**

**A. REASON**

Throughout the industry there is a growing concern over unapproved parts being installed on aircraft. The Federal Aviation Administration (FAA) places the responsibility on the person installing parts to determine the airworthiness of a part. The installer then assumes liability for the airworthiness of the part installed, which is particularly onerous if the aircraft is involved in an accident or incident.

Astra Jet Corporation (AJC) recognizes the difficulty an installer may have in determining a particular part's airworthiness, and to assist the installer, we have prepared this Service Information Letter (SIL).

**B. REFERENCE**

Code of Federal Regulations (CFR) Title 14

**C. PUBLICATIONS AFFECTED**

None

**D. DESCRIPTION**

AJC certifies that all parts in our inventory have been obtained from Israel Aircraft Industry (IAI) or IAI's approved sources and have been accepted under IAI's Civil Aviation Administration of Israel (CAAI) or AJC's FAA approved inspection system. All parts are traceable through IAI/AJC purchase orders and shipping documents.

**PARTS IMPORTED FROM ISRAEL**

All aircraft parts obtained from the manufacturer, IAI, come with a CAAI form 8130-3 "Authorized Release Certificate Approval Tag". This tag is equivalent to FAA's 8130-3 Certificate of Airworthiness. The United States and Israel have a bilateral agreement that requires each to recognize the airworthiness certification of the other.

AJC Quality Assurance (QA) has Designated Manufacturing Inspection Authority (DMIR) from the CAAI. The CAAI-DMIR is authorized to inspect and issue a CAAI form 8130-3 for any part manufactured in the United States, by IAI approved suppliers, that meets the FAA/CAAI criteria.

IAI often lists many different parts, quantities, and serial numbers on each 8130-3 tag. Since the possibility exists that these tags may be forged, to insure that only authorized copies of the tag are used for the respective part, each tag will have an AJC QA inspection stamp next to the part number it certifies. The AJC QA inspector will initial and date the copy and the AJC CAAI-DMIR will validate it using the raised seal of the CAAI. Inspection stamp, date and initials are in red ink to preclude counterfeiting (reference attached example).

**FAA PARTS MANUFACTURING APPROVAL (PMA)**

AJC has been granted Parts Manufacturing Approval by the FAA. Parts to be exported that were manufactured under FAA-PMA may be tagged airworthy by AJC's FAA-DMIR.

All PMA parts must be identified in accordance with the rules outlined in the Code of Federal Regulations (CFR) Title 14, Federal Aviation Regulation (FAR) 45.15. Astra Jet Corporation, a licensee of Israel Aircraft Industries, is required to identify all PMA parts as indicated below:

FAA-PMA  
ASTRA JET CORPORATION  
IAI P/N A07-25W357050-RE3  
Elig on Astra Model 1125

The identification is to be indelibly marked on the part or if the part is too small, on a tag attached to the part.

**TECHNICAL STANDARD ORDER (TSO)**

Many units such as radio transmitters and receivers, antennas, tires, brakes and other articles are produced to meet specific industry standards. The manufacturers of these products certify to the FAA that the products will satisfy the aircraft requirements.



SERVICE INFORMATION LETTER NO. 1124-20-102

Manufacturers will identify their product as TSO and indicate the classification under which the unit was certified, i.e., high frequency radio transmitting equipment may be produced under TSO-C31b whereas high frequency radio receiving equipment would be under TSO-C32b.

There is a standard method of product identification. CFR 14, FAR 21.607 requires that a TSO part be permanently and legibly marked as shown below in the following example:

ANTENNA, GLIDE SLOPE, DGI P/N RGS 10-48  
FAA TSO C34C  
DAYTON-GRANGER, INC FT. LAUDERDALE, FL

Any unit identified in this manner may be accepted as airworthy. An FAA 8130-3 tag or its equivalent CAA tag is required for export.

**STANDARD HARDWARE / QUALIFIED PRODUCT LIST (QPL)**

There are a number of standards in use today. These include, but are not limited to, MIL specs, AN, MS and NAS specifications for hardware. Various government agencies may approve manufacturers to produce one or more parts to these drawings. The manufacturers and their distributors may then have their names entered on a Qualified Products List (QPL) which is controlled by the Department of Defense along with the distributors of these products.

Standard Hardware is only obtained from IAI approved sources. AJC requires that all standard hardware be supplied with the name of the manufacturer and the manufacturer's lot or batch number. Certificates Of Conformance are kept on file by the manufacturer and can be made available through AJC.

FROM:		<b>"Your Rivet Specialist"</b> 89 Garden Street P.O. Box 745 Westbury, N.Y. 11590
PART#	MS14218AD5-4	
QUAN.#	100	
CTRL.#	B-73855	
P.O.#	MK3216	
<b>(516) 997-2333</b>		

FAA REPAIR STATION

When a part is repaired or overhauled, the FAA licensed repair station that performs this function will attach a release tag to the part. The tag is usually white or yellow and follows the format of the one shown below. Should the repair/overhaul description require more space than is allotted on the tag, a separate work order will be supplied in addition to the tag.

REPAIR RELEASE	
<p style="writing-mode: vertical-rl; transform: rotate(180deg);">REPAIR</p>	<p>NOMENCLATURE <i>MAAS IND</i>   P/N <i>26465-B2607</i>   S/N <i>376</i></p> <p>DESCRIPTION OF REPAIR <i>Re-cald MACH DIAL, MACH slots, A/S AKPM4 o/s.</i></p> <p><i>E/T per ATD 26465-B2607 Rev. C</i> SEE OTHER SIDE <input type="checkbox"/></p> <p>AUTHORIZED SIGNATURE <i>Tammy Dochow</i> DATE <i>OCT 8 1991</i></p> <p>PERTINENT DETAILS OF THIS REPAIR ARE ON FILE AT THIS REPAIR STATION UNDER REPAIR NUMBER <i>749568</i></p>
MAINTENANCE RELEASE	
<p style="writing-mode: vertical-rl; transform: rotate(180deg);">MAINTENANCE</p>	<p>THE COMPONENT IDENTIFIED ABOVE WAS REPAIRED AND INSPECTED IN ACCORDANCE WITH CURRENT REGULATIONS OF THE FEDERAL AVIATION ADMINISTRATION AND IS APPROVED FOR RETURN TO SERVICE.</p> <p>AUTHORIZED SIGNATURE <i>Bob L. West</i>   STATION CERT NO. <i>NX2R047L</i>   DATE <i>10-8-91</i></p> <p>F.A.A. REPAIR STA. NO. NX2R047L - INSTRUMENTS, 1, 2, 4 - ACCESSORIES, 1, 2, 4</p>

**Kollsman**

Aircraft Group

WICHITA DIVISION • 4729 PALISADE  
P.O. BOX 17028 • WICHITA, KS 67217



SUMMATION

It should be noted that AJC verifies that all parts are purchased from IAI approved sources, inspected by QA upon receipt and are in condition for safe operation. The following statement appears on all AJC packing lists:

**"AJC certifies that the products in this shipment have been inspected and are in compliance with the applicable drawings and specifications of approved manufacturers. Copies of supplier certifications are on file."**

Astra Jet Corporation and Israel Aircraft Industries hereby advise that an operator or service facility who uses unauthorized parts in any IAI manufactured aircraft shall do so at their own risk. If an unauthorized part is utilized anywhere on the aircraft, the operator or service facility will accept sole and full product liability responsibility for property damage or injury including death.

1. Country <b>מדינת ישראל</b> STATE OF ISRAEL		2. <input type="checkbox"/> Conformity <input checked="" type="checkbox"/> Airworthiness			<b>AUTHORIZED RELEASE CERTIFICATE APPROVAL TAG</b>		3. Certificate Ref No.  25-AT04746	
4. Organization  ISRAEL AIRCRAFT INDUSTRIES LTD (IAI) BEN GURION INTERNATIONAL AIRPORT 70100 ISRAEL						5. Work Order/Contract/Invoice  2581-0077000501		
6. Item	7. Description	8. Part No.	9. Eligibility	10. Qty.	11. Serial/Batch No.	12. Status/Work		
1	STRUT DOOR LH	263018-403A	MODEL 1124	3	NONE	NEW		
2	DOOR ASSY LH	263018-403	MODEL 1124	3	NONE	NEW		
3	STRUT DOOR RH	263018-404A	MODEL 1124	3	NONE	NEW		
4	STRUT DOOR RH	263018-404	MODEL 1124	3	NONE	NEW		
13. Remarks								
14. New Parts: Certifies that the part(s) identified above except as otherwise specified in block 13 was (were) manufactured/inspected in accordance with the airworthiness regulations of the stated country and/or in the case of parts to be exported with the approved design data and with the notified special requirements of the importing country.					15. Used Parts: Certifies that the work specified above except as otherwise specified in block 13 was carried out in accordance with the airworthiness regulations of the stated country and the notified special requirements of the importing country and in respect to that work, the part(s) is(are) in condition for safe operation and considered ready for release to service. (over)			
16. Signature  <i>Y. Tal</i>					19. Issued by or on behalf of the Civil Aviation Administration of Israel (CAAI).  CAAI AE-17			
17. Name (typed or printed)  YACOV TAL			18. Date 30 DEC 93					

**SAMPLE**

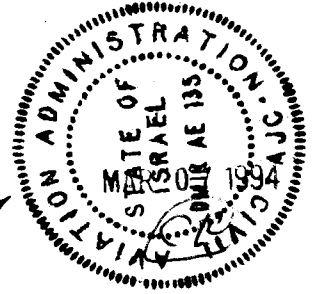

**AUTHORIZED RELEASE CERTIFICATE  
APPROVAL TAG:  
USER/INSTALLER RESPONSIBILITIES**

It is important to understand that the existence of this Document alone does not automatically constitute authority to install the part/component/assembly.

Where the user/installer works in accordance with the national regulations of an Airworthiness Authority different than the Airworthiness Authority of the country specified in block 1 it is essential that the user/installer ensures that his/her Airworthiness Authority accepts parts/components/assemblies from the Airworthiness Authority of the country specified in block 1.

Statements 14 and 15 do not constitute installation certification. In all cases the aircraft maintenance record must contain an installation certification issued in accordance with the national regulation by the user/installer before the aircraft may be flown.

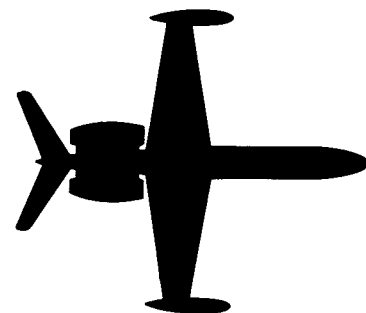

# **SERVICE INFORMATION LETTER**

**SERVICE INFORMATION LETTER NO. 1124-20-104**

**July 20, 1994**

**SUBJECT:           STANDARD PRACTICES - AIRFIELD CRASH CREW  
INFORMATION**

**EFFECTIVITY:   MODEL 1124/1124A WESTWIND, all serial numbers.**

**A.   REASON**

To provide airfield emergency services units with information prevalent to the model 1124/1124A Westwind.

**B.   REFERENCE**

None.

**C.   PUBLICATIONS AFFECTED**

None.

**D.   DESCRIPTION**

Please provide copies of the attached airfield crash crew information to the airfield emergency services units located at the airfield at which you are based and airfields you frequently visit. Additional copies of this SIL are available from Astra Jet Corporation, Technical Publications Department.

IAI MODEL 1124/1124A WESTWIND  
AIRFIELD CRASH CREW INFORMATION

LEFT AND RIGHT

THE EMERGENCY WINDOW  
CAN BE PUSHED IN ONLY

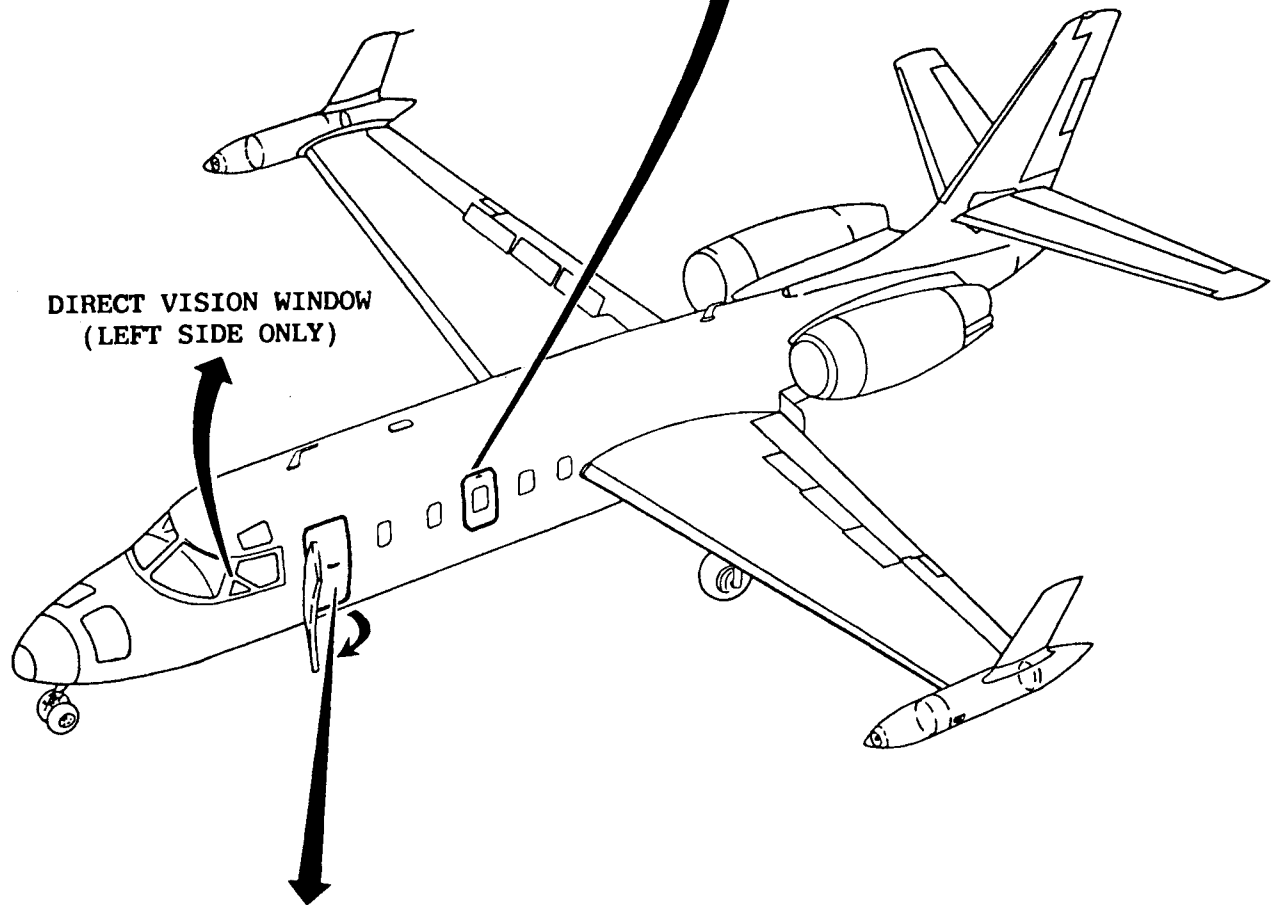
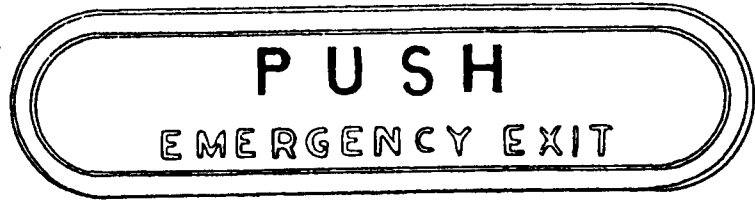

DIRECT VISION WINDOW  
(LEFT SIDE ONLY)



DOOR INITIALLY MOVE INBOARD  
THEN HINGES OUT (FORWARD)

**Emergency Exits**

IAI MODEL 1124/1124A WESTWIND  
AIRFIELD CRASH CREW INFORMATION

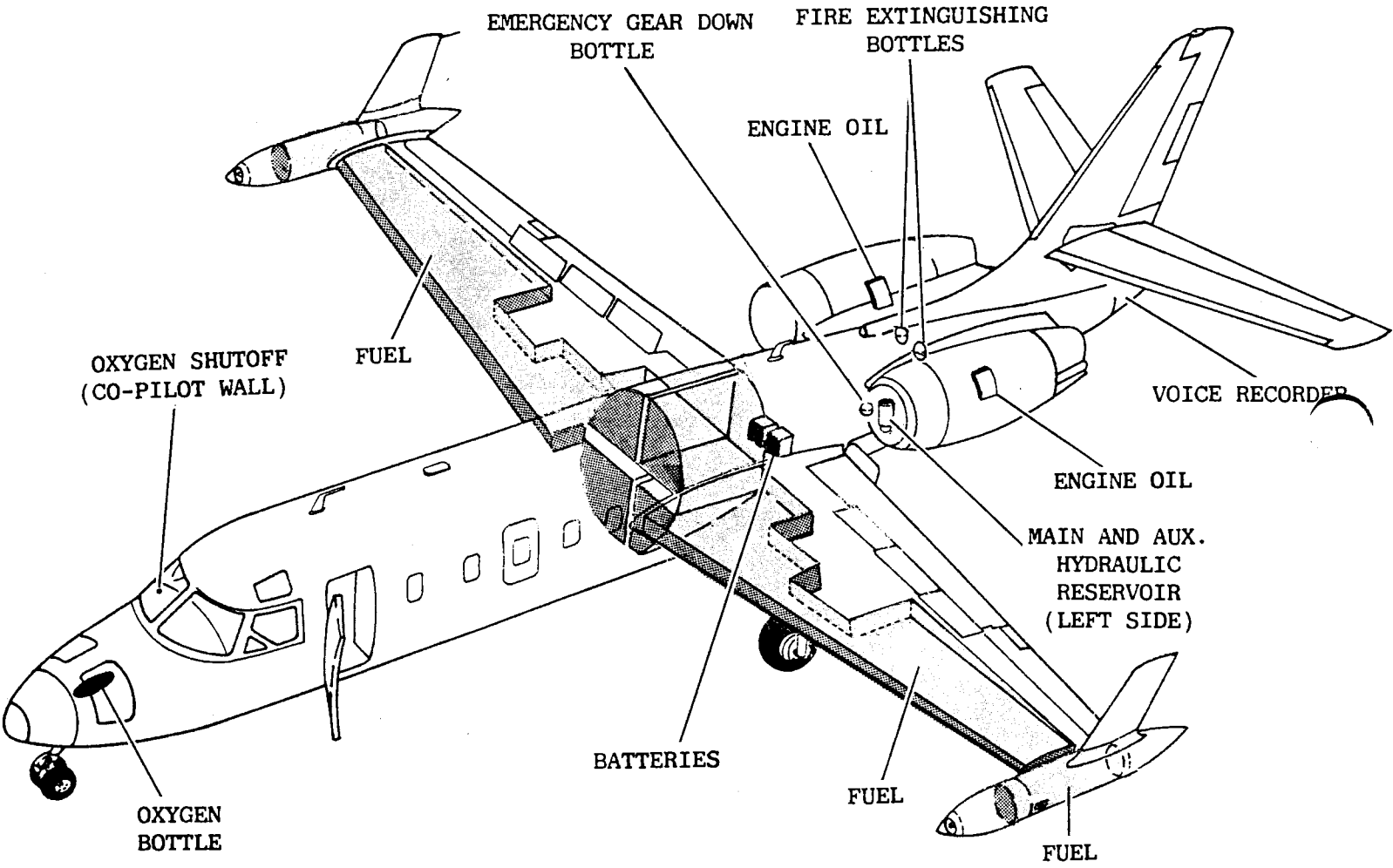

**Location of Flammable Fluids and Components**

IAI MODEL 1124/1124A WESTWIND  
AIRFIELD CRASH CREW INFORMATION

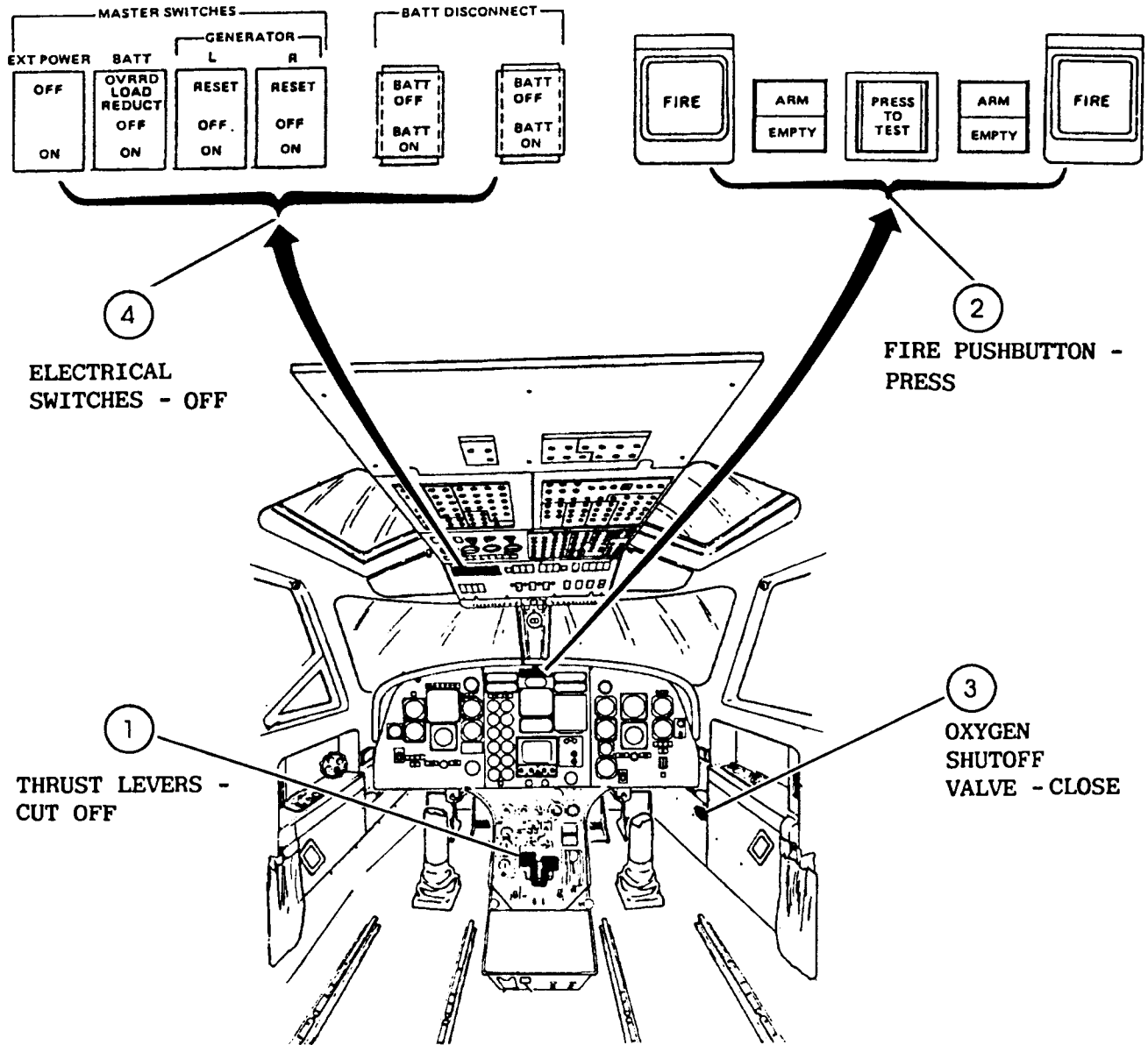

1. THRUST LEVERS - CUT OFF
2. FIRE PUSHBUTTONS - PRESS
3. OXYGEN SHUTOFF VALVE - CLOSE
4. ELECTRICAL SWITCHES - OFF

Shut Down Procedure



IAI MODEL 1124/1124A WESTWIND  
AIRFIELD CRASH CREW INFORMATION

LIFTING DISABLED AIRCRAFT - MAINTENANCE PRACTICES

1. General

- A. Aircraft weight should be reduced as much as possible. This may include defueling, if circumstances permit.
- B. Comply with all applicable jacking procedures prior to lifting disabled aircraft.
- C. In addition to lifting an aircraft, plans are required for equipment to remove the aircraft from the scene if gear cannot be lowered.
- D. Ensure lifting load is spread over as large an area as possible.
- E. Engine lifting points can also be used to stabilize aircraft.

2. Lifting Disabled Aircraft - Slings

NOTE: Comply with all applicable jacking procedures prior to lifting disabled aircraft.

A. Lifting Procedure

- (1) Ensure flaps in down position.
- (2) Remove the flap actuator access cover (located at wing station 33.00 right and left side). See Figure 3.  
  
NOTE: To remove the panel, remove 12 ea. (MS24694-52) screws and four rivets.
- (3) Pad area around leading edge where wing is joined to fuselage to prevent straps from slipping towards fuselage. See Figure 3.
- (4) Carefully drill out rivets in lower wing skin as indicated in Figure 3. Gently peel back skin to allow strap to pass through.
- (5) Disconnect flap actuator from fixing point at wing station 33.00 and remove actuator to gain access to fitting from right and left sides.

IAI MODEL 1124/1124A WESTWIND  
AIRFIELD CRASH CREW INFORMATION

- (6) Place strap around wing, ensure straps follow trace of wing station 33.00. Slide strap through opening at lower wing.

CAUTION: WING LEADING EDGES ARE CONSTRUCTED OF FIBREGLASS.

- (7) Place strap over actuator fitting, pad the fitting as required to ensure strap does not slip. Pass strap out through access panel. Repeat both sides of aircraft.

- (8) Place two straps around under side of fuselage and connect to strap on both sides of wing.

NOTE: These straps are only for preventing the straps on the wing from slipping and are not meant for lifting.

- (9) Place strap around nose of aircraft, ensure straps follow trace of frame.

- (10) Connect stabilizing strap from nose back to lifting limitations.

- (11) Check in Flight Manual, Section 1, Limitations for center-of-gravity of the aircraft to be lifted.

NOTE: According to the extent of damage to the aircraft, configuration may be affected. In this case add counter balance as required to regain correct center-of-gravity.

- (12) Adjust all straps on aircraft to remove slack and ensure that lifting point is on center line of aircraft.

- (13) Start lift carefully, ensure forward section of aircraft lifts just before aft section to avoid damage to fwd fuselage. Lift the aircraft vertically only.

3. Lifting Disabled Aircraft - Airbags

A. Lifting Procedure

- (1) Distribute bags as required.
- (2) Remove antenna as needed.
- (3) Inflate bags.
- (4) Lower gear, install dollies or add padded shoring as needed.

**Lifting Disabled Aircraft**  
**(Sheet 2 of 4)**

IAI MODEL 1124/1124A WESTWIND  
AIRFIELD CRASH CREW INFORMATION

STRAP 1-75 WIDE AEROQUIP  
P/N 30142. STRAPS TO BE  
FITTED WITH AEROQUIP  
31008 PIN TYPE BUCKLE  
FOR ADJUSTMENT

ENSURE STRAPS ARE POSITIONED  
SYMETRICALLY ABOUT CENTER  
LINE OF AIRCRAFT AND ARE  
THE SAME LENGTH.

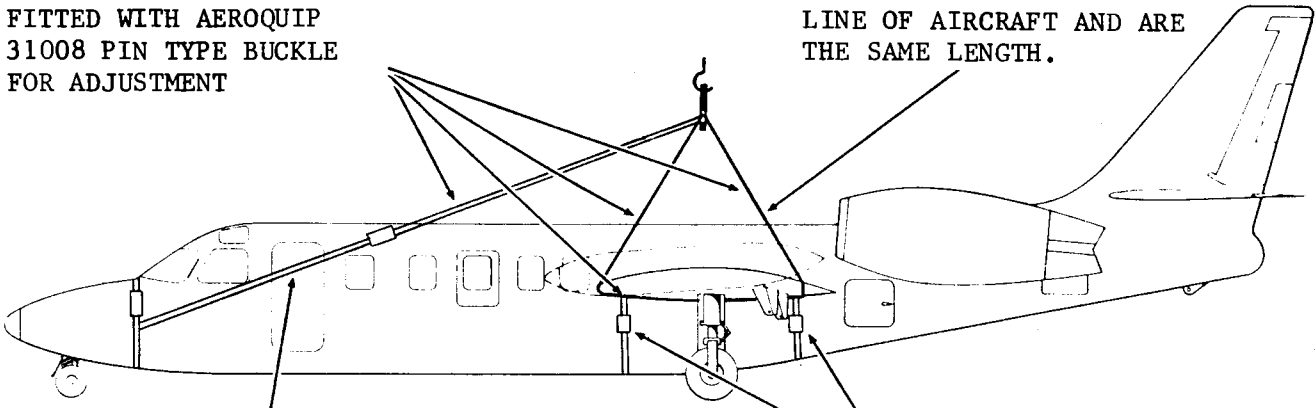

STRAP FOR STABILIZING  
FWD FUSELAGE

STRAPS AROUND FUSELAGE  
TO PREVENT STRAPS  
SLIPPING ALONG WING

PAD AROUND FUSELAGE IN  
THIS AREA BOTH SIDES OF  
AIRCRAFT TO PREVENT  
STRAPS SLIPPING TOWARD  
FUSELAGE

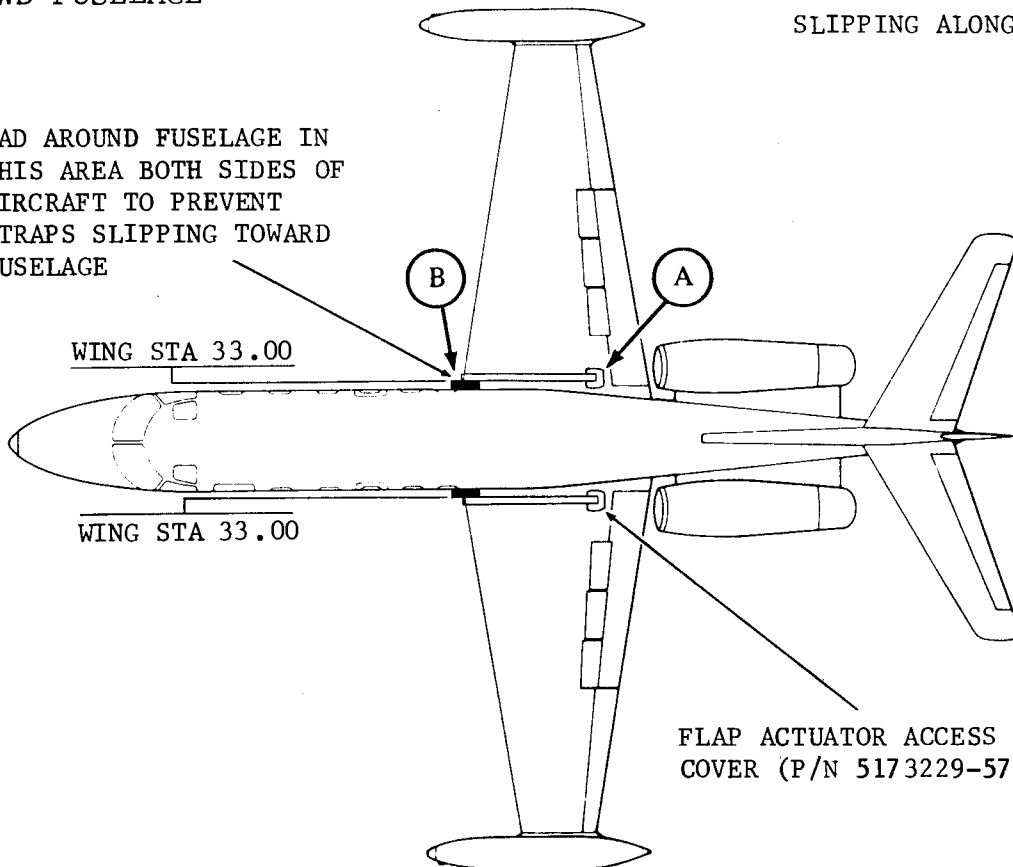

FLAP ACTUATOR ACCESS  
COVER (P/N 5173229-57 & 58)

IAI MODEL 1124/1124A WESTWIND  
AIRFIELD CRASH CREW INFORMATION

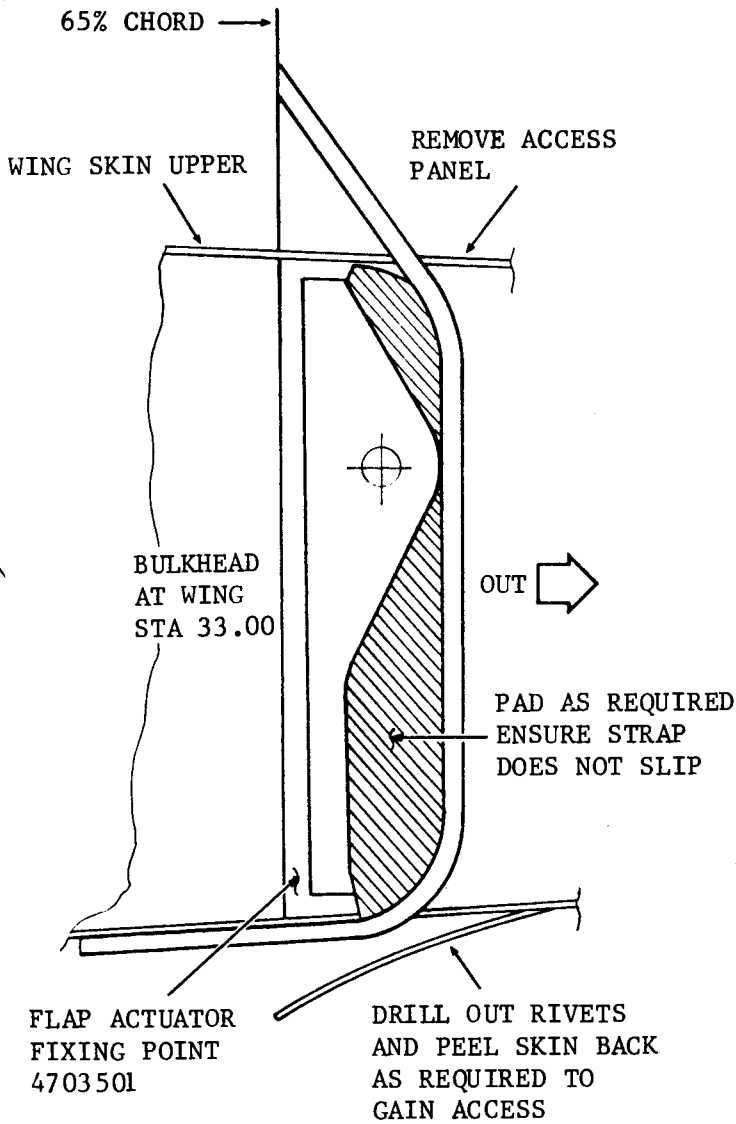

DETAIL A

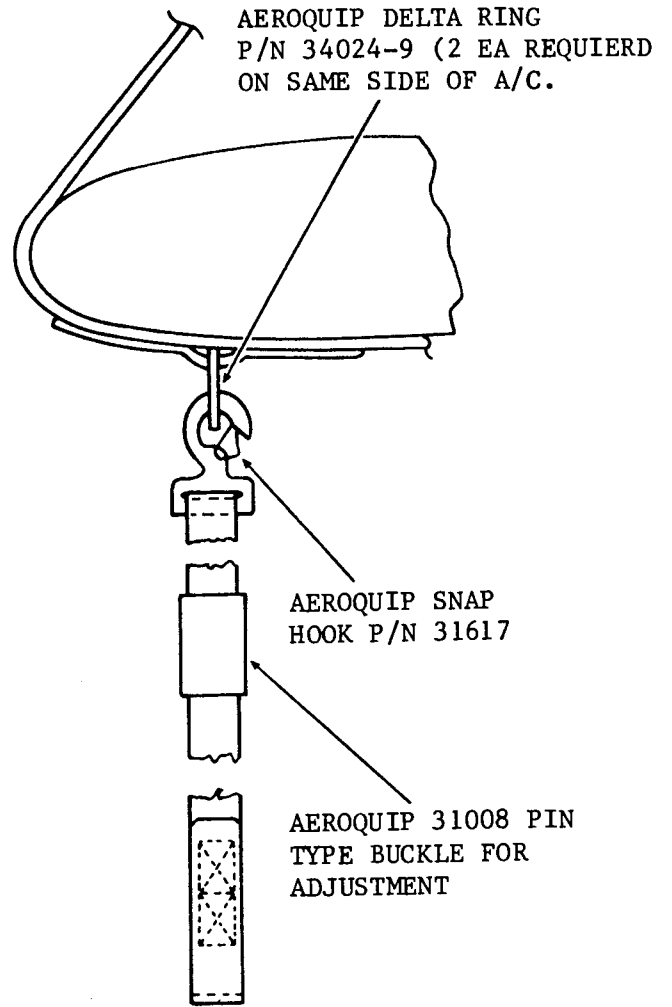

DETAIL B

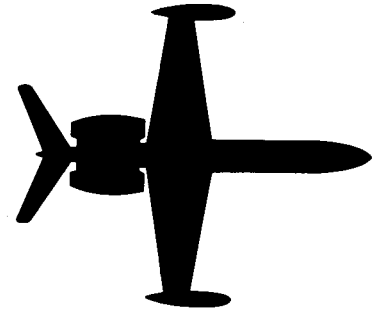

# SERVICE INFORMATION LETTER

SERVICE INFORMATION LETTER NO. 1124-12-110

April 19, 1995

**SUBJECT:** SERVICING - RENTAL TOOLING/COMPONENTS AVAILABLE THROUGH ASTRA JET CORPORATION

**EFFECTIVITY:** MODEL 1124/1124A WESTWIND, all serial numbers.

**A. REASON**

To advise maintenance personnel of rental tooling and components available through Astra Jet Corporation.

**B. REFERENCE**

None.

**C. PUBLICATIONS AFFECTED**

None.

**D. DESCRIPTION**

The following rental tooling and components are available through Astra Jet Corporation. Contact a Customer Service Representative to arrange rentals.

<u>Description</u>	<u>Part Number</u>
Exterior Placards Silk Screen Kit	WESTWIND 127
NDT Tooling Kit for Structural Inspection	TPUS-501
Horizontal Stabilizer Lower Scissor Fitting Transfer Fixture	AMD-1-WW4453504-501
Permaswage Tooling Kit	PERMASWAGE RENTAL

SERVICE INFORMATION LETTER NO. 1124-12-110

Description

Part Number

Thrust Reverser Bearing  
Staking Tool

ST1702-203 (# 4 Bearing)  
ST1702-204 (# 5 Bearing)  
ST1702-255 (# 6 Bearing)

Crew Oxygen Mask

MC1013-02

# **24-WESTWIND**

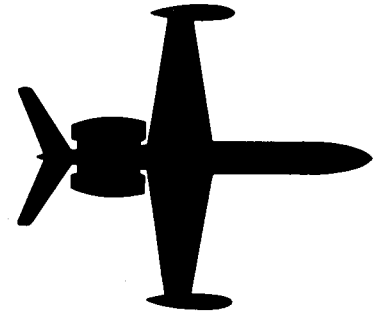

## **SERVICE INFORMATION LETTER**

---

**SERVICE INFORMATION LETTER NO. 1124-20-106**

**November 9, 1994**

**SUBJECT: STANDARD PRACTICES - NOISE LEVEL CERTIFICATE**

**EFFECTIVITY: MODEL 1124/1124A WESTWIND, all serial numbers.**

**A. REASON**

Airport authorities at some foreign airports are requesting from operators, documentation to certify Federal Aviation Regulation (FAR) 36, Stage 3 Noise Level compliance.

**B. REFERENCE**

FAA Type Certificate Data Sheet No. A2SW.  
FAA Advisory Circular No. 36-1F, Appendix 1.

**C. PUBLICATIONS AFFECTED**

None.

**D. DESCRIPTION**

Attached are certificates documenting that IAI Models 1124 Westwind and 1124A Westwind 2, meet FAR 36, Stage 3 Noise Levels. It is suggested that operators carry copies of this certificate on the aircraft at all times, especially when operating overseas.

Compliance with FAR 36 may be further documented by FAA Type Certificate Data Sheet No. A2SW, which indicates FAR 36 as part of the Certification Basis for both the Model 1124 and 1124A. FAA Advisory Circular 36-1F, Appendix 1, also lists Israel Aircraft 1124 Westwind and 1124A Westwind 2 as meeting FAR 36, Stage 3 Noise Levels.

# **ISRAEL AIRCRAFT INDUSTRIES LTD.**

*This is to certify that*

**IAI Model 1124 WESTWIND**

*meets*

*Federal Aviation Regulation (FAR) 36,  
Stage 3 Noise Levels.*

  
CHIEF PILOT



  
DIRECTOR, TECHNICAL SERVICES



# ***ISRAEL AIRCRAFT INDUSTRIES LTD.***

*This is to certify that*

**IAI Model 1124A WESTWIND 2**

*meets*

*Federal Aviation Regulation (FAR) 36,  
Stage 3 Noise Levels.*

  
CHIEF PILOT



  
DIRECTOR, TECHNICAL SERVICES

# 24-WESTWIND

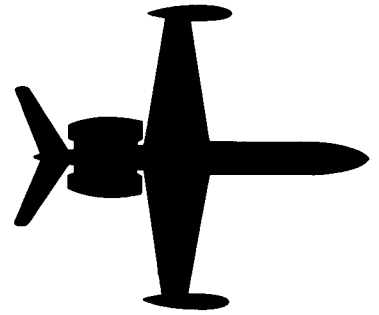

## SERVICE INFORMATION LETTER

---

---

SIL NO. 24-21-001

MARCH 15, 1984

SUBJECT: PRESSURIZATION - DELETION OF ADJUSTMENT FOR FLUID PRESSURE  
REGULATOR VALVE

Check and calibration of the fluid pressure regulator valve has been added to Chapter 21-50-00 page 501. The check as stated is a valid check whenever a sufficient source of bleed air can be supplied. With the installation in the Westwind there is not sufficient bleed air flow during ground operation to bring the fluid pressure regulator into the regulated pressure range of 22-26 PSIG.

This check and calibration has been deleted from AiResearch Report No. 4-272, dated 1 April 1983. The information in 1124/1124A Maintenance Manual Revision No. 9, dated Oct 18/82 should be disregarded until it can be removed in a forthcoming revision. Do not use this check to determine proper valve operation.

Page 1 of 1



SUBSIDIARY OF ISRAEL AIRCRAFT INDUSTRIES, LTD.  
BEN GURION AIRPORT, ISRAEL

# SERVICE PUBLICATIONS

# revision notice

---

SIL NO. 1124-21-007  
Revision No.1

August 9, 1985

SUBJECT: ADJUSTMENT PROCEDURES FOR THE 3213894-1-1 BLEED SWITCHING VALVE.

EFFECTIVITY: MODEL 1124/1124A, all serial numbers.

REASON FOR

REVISION: To change the dimension of a jam-nut on page 2 and page 3.

D. ADJUSTMENT PROCEDURES:

- (3) With the engine operating at approximately 60%  $N_1$  throttle setting, loosen the 15/64" jam-nut on the end of the thermal compensator (see Figure 1), turn the adjusting screw, utilizing a 1/16" Allen wrench, clockwise to increase or counter-clockwise to decrease. Retorque jam-nut after adjustment.

NOTE

The 15/16" jam-nut reflected in Figure 1 on page 3 of 3 should be 15/64."

SIL NO. 1124-21-007  
Page 1 of 1



SUBSIDIARY OF ISRAEL AIRCRAFT INDUSTRIES. LTD  
BEN GURION AIRPORT, ISRAEL

# 1124-WESTWIND

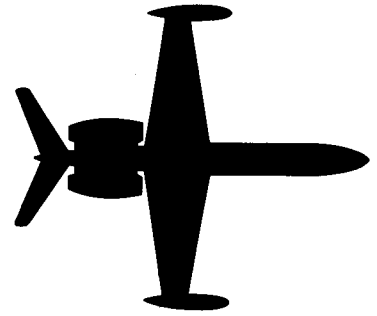

## SERVICE INFORMATION LETTER

---

---

SIL NO. 1124-21-007

December 11, 1984

SUBJECT: ADJUSTMENT PROCEDURES FOR THE 3213894-1-1 BLEED SWITCHING VALVE.

EFFECTIVITY: MODEL 1124/1124A, all serial numbers.

### A. REASON

To adjust the high-stage regulated pressure of both Bleed Switching Valves for equal output with the valve installed in the aircraft.

### NOTE

This adjustment should be limited to one-half PSI increasing or decreasing because of the effects on the thermal reset feature.

### B. REFERENCES

1124 Maintenance Manual, Chapter 21-11-00, page 4 and Figure 2, page 5.

### C. PUBLICATION AFFECTED

1124 Maintenance Manual, Chapter 21-11-00, page 4 and 6 will be revised to reflect these adjustment procedures.



SUBSIDIARY OF ISRAEL AIRCRAFT INDUSTRIES, LTD.  
BEN GURION AIRPORT, ISRAEL

SIL 1124-21-007  
Page 1 of 3

D. ADJUSTMENT PROCEDURES:

- (1) Install regulator test adapter P/N 296529-4 (Ref. Figure 1) in the secondary pressure regulator downstream pressure port.
- (2) Attach a 0-30 psig gauge to the 296529-4 adapter utilizing a appropriate union and hose assembly.
- (3) With the engine operating at approximately 60%  $N_1$  throttle setting, loosen the 15/16" jam-nut on the end of the thermal compensator (see Figure 1), turn the adjusting screw, utilizing a 1/16" allen wrench, clockwise to increase or counter-clockwise to decrease. Retorque jam-nut after adjustment.

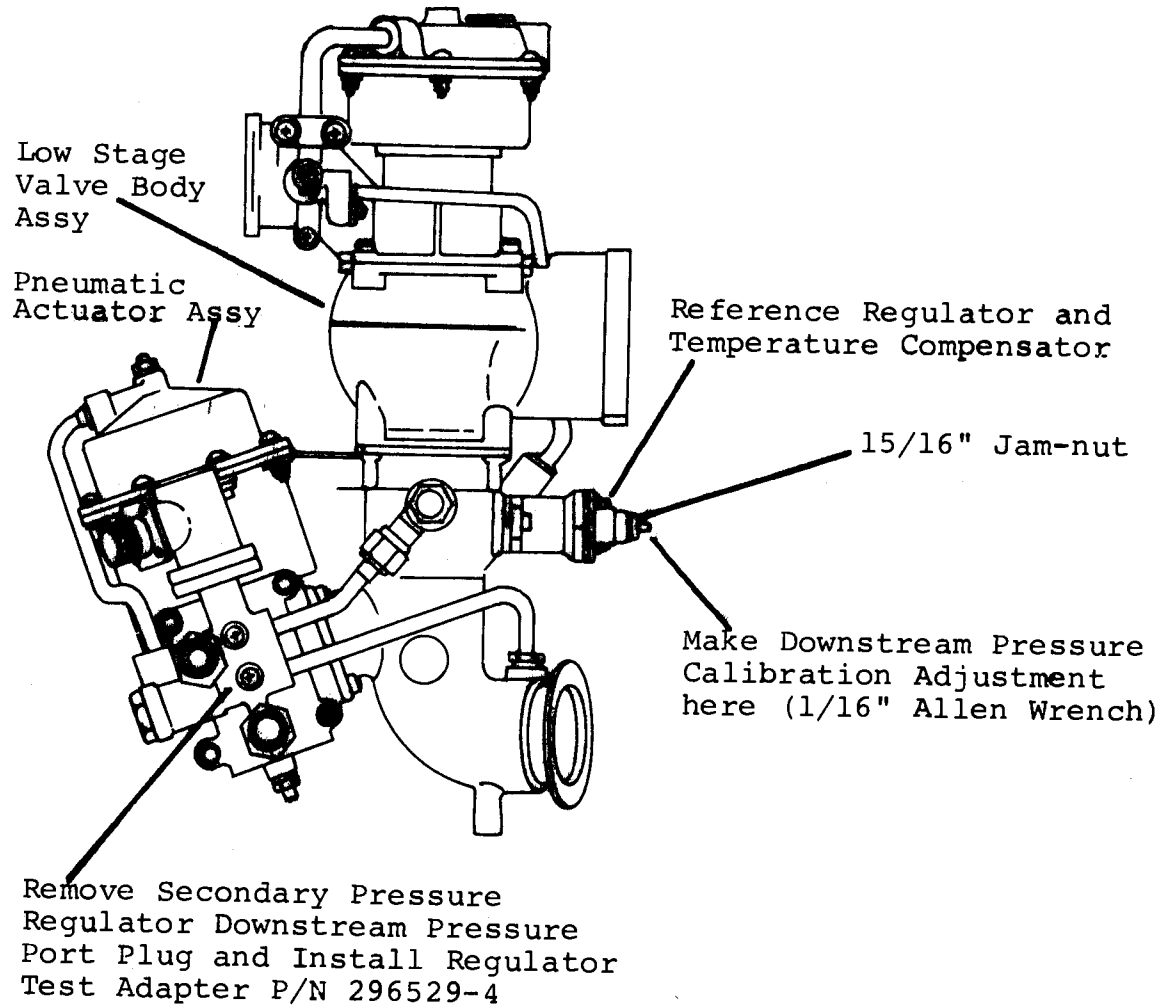

NOTE

Pneumatic Actuator Body Assembly

Adjustment should be limited to one-half psi increasing or decreasing.

10/32" Thread

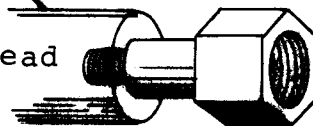

3213894-1-1 BLEED SWITCHING VALVE ADJUSTMENTS

FIGURE 1

# 1124-WESTWIND

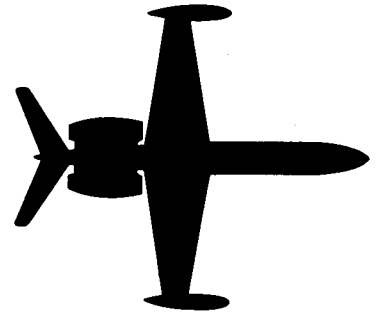

## SERVICE INFORMATION LETTER

---

---

SIL NO. 1124-21-013

February 6, 1985

SUBJECT: APPROVED ALTERNATE LUBRICANTS FOR AIRESEARCH COOLING  
TURBINE 572375-1-2 and -3.

EFFECTIVITY: MODEL WESTWIND 1124/1124A, all serial numbers.

A. REASON

To provide an alternate list of cooling turbine lubricants.

B. REFERENCES

Airesearch Operations and Maintenance Instructions Report  
No. 4-272 and Qualified Products List-23699-11.

C. PUBLICATIONS AFFECTED

The 1124 Maintenance Manual, Chapter 12, will be revised to  
include alternate oils reflected in this SIL.

D. DESCRIPTION

The following lubricants listed under MIL-L-23699 may be used  
as a substitute for Exxon 2380 and Mobil Jet II Oil. All  
products listed herein have been qualified under the  
requirements for the product as specified in the latest  
effective issue of the applicable specification. This list  
is subject to change without notice; revision or amendment  
of this list will be issued as necessary. The listing of a  
product does not release the supplier from compliance with  
the specification requirements.

February 6, 1985



SUBSIDIARY OF ISRAEL AIRCRAFT INDUSTRIES, LTD.  
BEN GURION AIRPORT, ISRAEL

SIL 1124-21-013  
Page 1 of 7

SERVICE INFORMATION LETTER 1124-21-013

GOVERNMENT DESIGNATION	MANUFACTURER'S DESIGNATION	TEST OR QUALIFICATION REFERENCE	MANUFACTURER'S NAME AND ADDRESS
None	PQ Turbine Lubricant 6423	O-7A 12 Jan 1966	American Oil & Supply Co. 238 Wilson Ave Newark, NJ 07105
None	PQ Turbine Lubricant 6700	O-5A-1 2 June 1965	
None	PQ Turbine Lubricant 3889	O-6B-2 6 Dec 1978	
None	PQ Turbine Lubricant 3893	O-6C-1 6 Dec 1978	
None	PQ Turbine Lubricant C-3788	O-13A-1 30 Jun 1978	
None	PQ Turbine Lubricant 9598	O-9D-1 6 Nov 1975	
None	Brayco 899	O-8A 13 Feb 1967	Bray Oil Co. 9550 Flair Dr. El Monte, CA 91731
None	Brayco 899G	O-5A-3 20 Sep 1965	Plant: 1925 North Marianna Ave. Los Angeles, CA. 90032
None	Brayco 899G	O-5A-3 20 Dec 1965	
None	Brayco 899M	O-13A-2 18 Jul 1978	
None	Brayco 899M	O-13A-3 18 Jul 1978	



SERVICE INFORMATION LETTER 1124-21-013

GOVERNMENT DESIGNATION	MANUFACTURER'S DESIGNATION	TEST OR QUALIFICATION REFERENCE	MANUFACTURER'S NAME AND ADDRESS
None	Castrol 5000	O-5B-2 8 June 1977	Burmah-Castrol Corp. Burmah House Pipers Way Swindon Wilts SN3 1RE United Kingdom
None	EMGARD Synthesized Turbine Lubricant (2952)	O-13A 5 June 1978	Emery Industries, Inc. 4900 Estee Avenue Cincinnati, OH 45233
None	EMGARD Synthesized Turbine Lubricant (2949)	O-13B 22 Sep 1982	
None	EXXON Turbo Oil 2380 ESSO Turbo Oil 2380	O-4A 5 Nov 1964	EXXON Company, USA P.O. Box 2180 Houston, TX 77001
	EXXON Turbo Oil 2380 ESSO Turbo Oil 2380	O-4C 23 May 1979	
	EXXON Turbo Oil 2380 ESSO Turbo Oil 2380	O-4D 23 May 1979	
	EXXON Turbo Oil 2380 ESSO Turbo Oil 2380	O-4E 23 May 1979	

SERVICE INFORMATION LETTER 1124-21-013

GOVERNMENT DESIGNATION	MANUFACTURER'S DESIGNATION	TEST OR QUALIFICATION REFERENCE	MANUFACTURER'S NAME AND ADDRESS
None	ESSO Turbo Oil 2380	O-4F 30 Mar 1982	EXXON Company USA (continued)
None	ESSO Turbo Oil 2380	O-4G 4 Nov 1982	
None	ESSO Turbo Oil 2380	O-4H 28 Dec 1982	
None	HATCOL 3211	O-5A 9 Nov 1964	Hatco Chemical Corp. King George Post Road Fords, NJ 08863
None	HATCOL 3611	O-5B 31 Jan 1966	
None	HATCOL 1639	O-5C 26 Aug 1981	
None	HATCOL 1680	O-8A-1 23 Feb 1981	
None	RM-139A	O-1A	Mobil Oil Corp. 150 E 42nd St. New York, NY 10017
None	RM-147A	O-1C 1 Sep 1967	
None	RM-247A	O-1D 4 Feb 1975	Plant: Mobil Chemical Co. Rt. 27 and Vineland Road Edison, NJ 08817

SERVICE INFORMATION LETTER 1124-21-013

GOVERNMENT DESIGNATION	MANUFACTURER'S DESIGNATION	TEST OR QUALIFICATION REFERENCE	MANUFACTURER'S NAME AND ADDRESS
None	RM-246A	O-1E 5 May 1975	
None	Rm-249A	O-1F 10 Feb 1976	
None	RM-254A	O-1G 9 Oct 1979	
None	Rm-270A	O-1H 23 Sep 1982	
None	TURBONYCOIL 599	O-13A-4 24 Sep 1980	NYCO S.A. 66 Avenue Des Champs' Ely 75008 Paris France
None	Nyco 599A	O-13A-5	Nyco Internatinal 6922 Cavalcade St. Houston, TX 77028
None	Nyco 599B	O-13B-1 15 Oct 1982	
None	STO-5700	O-9D	PVO Int'l Inc. 416 Division St. Boonton, NJ 07005
None	Royco 899	O-3A 20 Apr 1964	Royal Lubricants Co., Inc. River Rd. Hanover, NJ 07936

February 6, 1985

SERVICE INFORMATION LETTER 1124-21-013

GOVERNMENT DESIGNATION	MANUFACTURER'S DESIGNATION	TEST OR QUALIFICATION REFERENCE	MANUFACTURER'S NAME AND ADDRESS
None	Royco 899B (D-759-3)	O-3B 6 June 1978	
None	Royco 899C (D-758)	O-3C 6 June 1979	
None	Royco 899HC	O-5A-4 20 July 1978	
None	Royco 899E-L	O-13A-6 29 Dec 1982	
None	Royco 899E-1	O-13A-7 29 Dec 1982	
None	Royco 899E-2	O-13B-2 29 Dec 1982	
None	Royco 899E-2	O-13B-3 29 Dec 1982	
None	Aeroshell Turbine Oil 500	O-3B-1 11 Dec 1979	Shell Oil Co. Inc. Quality Assurance Products Manufacturing P.O. Box 2465 One Shell Plaza Houston, TX 77001  Plant: Royal Lubricants Co., Inc. River Rd. Hanover, NJ 07936

SERVICE INFORMATION LETTER 1124-21-013

GOVERNMENT DESIGNATION	MANUFACTURER'S DESIGNATION	TEST OR QUALIFICATION REFERENCE	MANUFACTURER'S NAME AND ADDRESS
None	AeroShell Turbine Oil 500	O-3B-2 9 Mar 1983	Shell Int'l Petroleum Co., Ltd. Shell Centre London SE1 7NA England United Kingdom
None	AeroShell Turbine Oil 500	O-3C-1 7 Mar 1983	Shell Centre London SE1 7NA England United Kingdom
None	Stauffer JET II (9624)	O-63 19 Feb 1970	Stauffer Chemical Co. Gallipolis Serry West Virginia 25515
None	Stauffer STL (E-7306)	O-6C 22 Nov 1978	

# **24-WESTWIND**

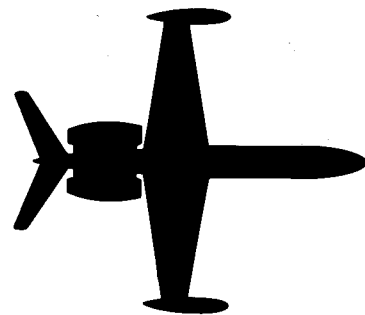

## **SERVICE INFORMATION LETTER**

---

---

SIL NO. 1124-21-014

February 8, 1985

SUBJECT: PRESSURIZATION - MAINTENANCE OF OUTFLOW VALVES

EFFECTIVITY: MODEL 1124/1124A, all serial numbers.

A. REASON

To recommend the need for occasional cleaning of outflow valves.

B. REFERENCES

Maintenance Manual, Chapter 21.

C. PUBLICATIONS AFFECTED

None

D. DESCRIPTION

Reports from the field reveal that the outflow valves in the pressurization system are being contaminated by a nicotine buildup on the valve seat. Sufficient buildup of nicotine will also clog filters and eventually affect the operation of the pressurization system. Close attention should be given to Chapter 21-30-00, page 404 in the Maintenance Manual when cleaning the outflow valves.



SUBSIDIARY OF ISRAEL AIRCRAFT INDUSTRIES, LTD.  
BEN GURION AIRPORT, ISRAEL

SIL 1124-21-014  
Page 1 of 1

# 1124-WESTWIND

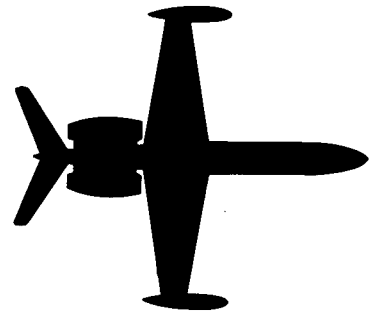

## SERVICE INFORMATION LETTER

---

---

SIL NO. 1124-21-017

February 12, 1985

SUBJECT: COOLING TURBINE - OIL SUMP DRAIN PLUG ACCESSIBILITY  
IMPROVEMENT

EFFECTIVITY: MODEL 1124/1124A WESTWIND aircraft, all serial  
numbers.

A. REASON

To improve the accessibility of the cooling turbine oil  
sump drain plug.

B. REFERENCES

None.

C. PUBLICATIONS AFFECTED

None.

D. DESCRIPTION

As shown in Figure 1, the cooling turbine mounting bracket  
blocks access to the oil sump drain plug. Routing out the  
bracket, as shown, will allow the drain plug to be removed  
and replaced with a socket wrench. Trim no more material  
than necessary from the bracket.

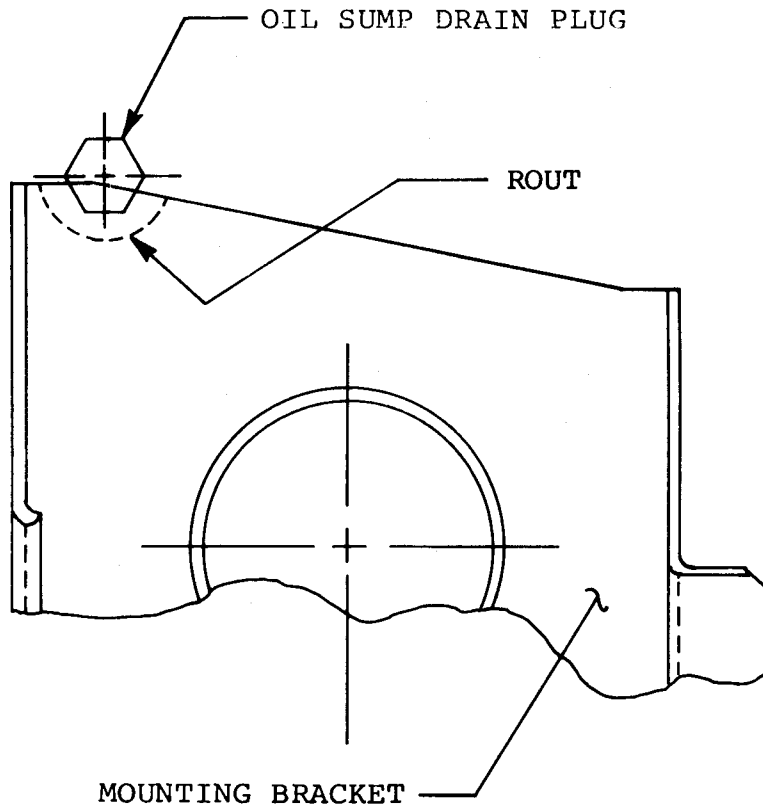
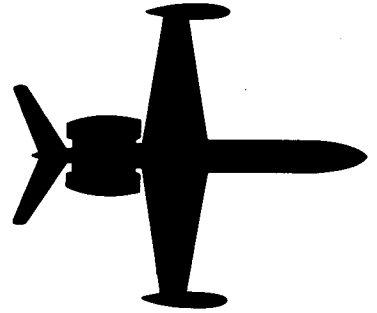

FIGURE 1: VIEW LOOKING UP AT BOTTOM OF COOLING TURBINE



# 1124-WESTWIND



## SERVICE INFORMATION LETTER

---

SIL NO. 1124-21-043

April 2, 1985

SUBJECT: IMPROVED GASKETS FOR BLEED SWITCHING VALVE

EFFECTIVITY: 1124/1124A WESTWIND, all serial numbers.

A. REASON

To announce the availability of improved gaskets for use in the P/N 783647-3 bleed switching valve installation.

Information supplied in this service information letter will be included in the next scheduled revision to the 1124/1124A Illustrated Parts Catalog.

B. REFERENCES

None

C. PUBLICATIONS AFFECTED

1124/1124A Illustrated Parts Catalog, Chapter 21-20-00.

D. DESCRIPTION

When replacing a bleed switching valve also order kit number 21-4001 which will include all gaskets and hardware required for replacement of a BSV.

Install all gaskets in mating connections dry. Do not use RTV compounds of any type in the installation. Install all low and high pressure inlet flange bolts with Fel-pro C5-A Hi-Temp anti-seize lubrication (or equivalent).



SUBSIDIARY OF ISRAEL AIRCRAFT INDUSTRIES, LTD.  
BEN GURION AIRPORT, ISRAEL

SIL 1124-21-043  
Page 1 of 2

SERVICE INFORMATION LETTER NO. 1124-21-043

Kit number 21-4001 includes the following parts:

<u>QTY</u>	<u>PART NUMBER</u>	<u>DESCRIPTION</u>
1 ea.	612-A51-0038-2	Gasket
1 ea	67618	Gasket
1 ea.	783619-1	Gasket
4 ea.	MS24678-10	Screw

END

# 24-WESTWIND

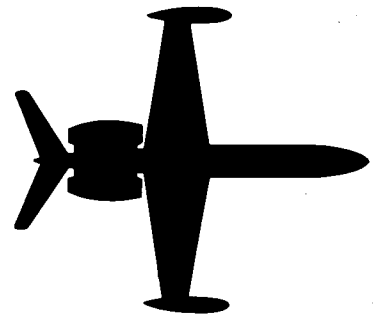

## SERVICE INFORMATION LETTER

---

SERVICE INFORMATION LETTER NO. 1124-21-066B

June 30, 1987

(This Service Information Letter No. 1124-21-066B dated June 30, 1987 supersedes SIL No. 1124-21-066A dated January 9, 1987 and SIL No. 1124-21-066 dated September 15, 1986 in their entirety.)

SUBJECT: AIR CONDITIONING - IMPROVED BLEED SWITCHING VALVE  
(Garrett P/N 3213894-4-1)

EFFECTIVITY: 1124/1124A MODEL WESTWINDS, all serial numbers.

### A. REASON

To alert 1124 operators that a Service Bulletin revision has been published by Garrett regarding the switching valve.

### B. REFERENCES

Garrett/Airesearch Service Bulletin No. 3213894-36-1421 dated April 30, 1986, revised July 31, 1986.

### C. PUBLICATIONS AFFECTED

1124/1124A Illustrated Parts Catalog, Chapter 21.

### DESCRIPTION

Attached, for your convenience, is page 3 of 4 of the revised Garrett Service Bulletin No. 3213894-36-1421 dated April 30, 1986, Revision No. 1 dated July 31, 1986. Page 3 of 4 reflects the only changes to this bulletin.



SUBSIDIARY OF ISRAEL AIRCRAFT INDUSTRIES, LTD.  
BEN GURION AIRPORT, ISRAEL

SIL 1124-21-066B  
Page 1 of 1



# SERVICE BULLETIN

GARRETT FLUID SYSTEMS COMPANY

## 2. Accomplishment Instructions

- R A. Valve P/N 3213894-1-1 is replaced by an improved valve P/N 3213894-4-1.  
Garrett Fluid System Company recommends both aircraft valves be -4 configuration for improved system performance.
- R If the valves are of a mixed configuration, that is one -1 valve and one  
R -4 valve, the -1 valve will control and no improvement in system per-  
R formance will be achieved.

# *Service Information Letter*

S/N \_\_\_\_\_

## *Certificate of Compliance*

PLEASE FILL IN THE REQUIRED DATA BELOW AND RETURN TO:

ISRAEL AIRCRAFT INDUSTRIES INTERNATIONAL, INC.  
P.O. BOX 10086  
WILMINGTON, DE 19850  
ATTN: TECHNICAL PUBLICATIONS

This is to certify that 1124 Model Westwind Aircraft  
S/N \_\_\_\_\_ has complied with Garrett/Airesearch Service  
Bulletin No. 3213894-36-1421, Improved Bleed Switch Valve,  
announced in SIL No. 1124-21-066B.

Aircraft Registration No. \_\_\_\_\_

Airframe Total Time at Compliance \_\_\_\_\_

Compliance Date \_\_\_\_\_ By \_\_\_\_\_  
Signature

OWNER:

ACCOMPLISHING AGENCY:

_____	_____
_____	_____
_____	_____
_____	_____

Please describe below any discrepancies found or difficulties  
encountered during compliance:

\_\_\_\_\_

\_\_\_\_\_

\_\_\_\_\_

\_\_\_\_\_

\_\_\_\_\_

\_\_\_\_\_

# **24-WESTWIND**

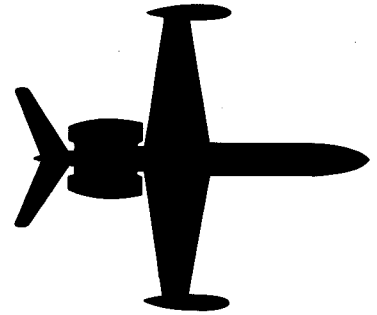

## **SERVICE INFORMATION LETTER**

---

---

SERVICE INFORMATION LETTER NO. 1124-21-069

JANUARY 16, 1987

SUBJECT: AIR CONDITIONING - IMPROVED BLEED SWITCHING VALVE BODY  
SEALS

EFFECTIVITY: 1124/1124A WESTWINDS, all models

**A. REASON**

To announce the availability of a new, improved bleed switching valve body packing.

**B. REFERENCES**

Garrett/Airesearch Service Bulletin No. 3213894-36-1419 dated May 30, 1986.

**C. PUBLICATIONS AFFECTED**

1124/1124a Illustrated Parts Catalog, Chapter 21.

**D. DESCRIPTION**

For your convenience, a copy of Garrett Service Bulletin No. 3213894-36-1419 is attached.



SUBSIDIARY OF ISRAEL AIRCRAFT INDUSTRIES, LTD.  
BEN GURION AIRPORT, ISRAEL

SIL 1124-21-069  
Page 1 of 1



# SERVICE BULLETIN

GARRETT PNEUMATIC SYSTEMS DIVISION

PNEUMATIC-PRESSURE REGULATING AND SHUTOFF VALVE - Replacement of High and Low Pressure Inlet Flange Packings.

## 1. Planning Information

### A. Effectivity

This service bulletin is applicable to the following regulating and shutoff pneumatic pressure valve.

<u>Part No.</u>	<u>Model No.</u>	<u>Prior to Serial No.</u>	<u>Application</u>
3213894-1-1	NA	ALL	Westwind 1121/1123/1124

### B. Reason

Reports from the field and Garrett overhaul shop have indicated a short service life of the high and low pressure flange packings resulting in excessive bleed-air leakage.

Garrett Pneumatic Systems Division has designed a new packing configuration that reorients the fiberglass laminate 90 degrees and provides additional squeeze for improved sealing. In addition, high temperature tests have been completed to verify the acceptability of the design.

### C. Description

This service bulletin provides instructions for removal of existing flange packings and replacing with new improved static face seal packings.

### D. Approval

Not applicable.

### E. Manhour Requirements

It is assumed that the unit is removed from the aircraft.

No additional manhours are required to accomplish this change when performed at overhaul or when repair necessitates access to the affected part.



# SERVICE BULLETIN

GARRETT PNEUMATIC SYSTEMS DIVISION

## F. Material - Price and Availability

Information regarding availability of parts may be obtained from one of the following facilities.

Garrett General Aviation Services Co., Los Angeles Intercontinental Airport, 6201 West Imperial Hwy., Los Angeles, CA 90045.

Garrett General Aviation Services Co., MacArthur Airport, 2221 Smithtown Avenue, Ronkonkoma, Long Island, NY 11779.

Garrett General Aviation Services Co., Houston Intercontinental Airport, 17250 Chanute Road, Houston, TX 77205.

Garrett General Aviation Services Co., P.O. Box 68, Route 3, Bush Field, Augusta, GA 30910.

Garrett General Aviation Services Co., Capitol Airport, P.O. Box 2177, Springfield, IL 62705.

Garrett GMBH, Frankfurter - Strasse 51, Postfach 1150, 6096 Raunheim AM/Main, West Germany.

Garrett Singapore, Pty Ltd, 161 Gul Circle, Jurong Town, P.O. Box 166, Singapore 9161, Singapore.

Garrett Aerospace Pty. Ltd., 18-22 Murray Street, Marrickville, NSW, 2204 Australia.

## G. Tooling - Price and Availability

No special tooling required except that already listed in referenced manual(s).

## H. Weight and Balance

No change.

## I. Publications References

None.

## J. Service Bulletin References

None.

## K. Other Publications Affected

None.





# SERVICE BULLETIN

GARRETT PNEUMATIC SYSTEMS DIVISION

## 2. Accomplishment Instructions

A. Separate valve into three major subassemblies to gain access to packings as follows. (See Figure 1.)

- (1) Remove four existing screws (MS16996-10) and loosen tube bushing nut of high pressure inlet assembly.
- (2) Separate high pressure inlet assembly from low pressure inlet assembly.
- (3) Remove and discard old packing (3171314-2).

NOTE: Existing studs (3163533-1) are 0.88 to 0.90 inch long and existing studs (3163533-2) are 1.00 to 1.02 inch long. Tag existing studs when removed to facilitate reassembly.

- (4) Remove two existing studs (3163533-1) and two existing studs (3163533-2) of low pressure inlet assembly.
- (5) Separate low pressure inlet assembly from secondary pressure regulating and shutoff assembly.
- (6) Remove and discard old packing (3171314-1).

B. Assemble major subassemblies with new packings as follows. (See Figure 1.)

### CAUTION

ENSURE ALL OLD PACKING MATERIAL IS REMOVED FROM FLANGE GROOVES PRIOR TO INSTALLING NEW PACKINGS TO PREVENT LEAKAGE.

- (1) Install new packing (3171314-3) and low pressure inlet assembly on secondary pressure regulating and shutoff assembly. Secure with two existing studs (3163533-1) and two existing studs (3163533-2).
- (2) Install new packing (3171314-4) and high pressure inlet assembly on low pressure inlet assembly. Tighten tube bushing nut of high pressure inlet assembly. Secure with four existing screws (MS16996-10).

C. Perform leakage check of valve as follows.

- (1) Cap high and low pressure inlet ports.
- (2) Install an adapter on the outlet port of secondary pressure regulating and shutoff assembly.
- (3) Connect an air source (100 psi) to adapter.
- (4) Apply approximately 100 psig and using leak detection compound, check for leakage around new packing flanges and tube fittings. Frothing and small bubbles are acceptable.



# SERVICE BULLETIN

GARRETT PNEUMATIC SYSTEMS DIVISION

- (5) Reduce air pressure to zero and remove adapter and caps.
- D. Upon completion of this change, stamp Change No. 7 on the component identification plate adjacent to MOD RECORD.



# SERVICE BULLETIN

GARRETT PNEUMATIC SYSTEMS DIVISION

HIGH PRESSURE  
INLET ASSEMBLY

EXISTING SCREW  
P/N MS16996-10  
(QTY 4)

NEW PACKING  
P/N 3171314-4

LOW PRESSURE  
INLET ASSEMBLY

NEW PACKING  
P/N 3171314-3

EXISTING STUD  
P/N 3163533-1  
(QTY 2)

SECONDARY PRESSURE REGULATING  
AND SHUTOFF ASSEMBLY

EXISTING STUD  
P/N 3163533-2  
(QTY 2)

32138945B1

Regulating and Shutoff Pneumatic Pressure Valve  
Figure 1

May 30/86

3213894-36-1419  
Page 5 of 6



# SERVICE BULLETIN

GARRETT PNEUMATIC SYSTEMS DIVISION

### 3. Material Information

The following parts are required to accomplish the instructions outlined in this service bulletin.

New PN	Quantity	Unit List Price*	Key Word	Old PN	Instructions-Disposition
3171314-3	1		Packing	3171314-1	B, G, K, N
3171314-4	1		Packing	3171314-2	B, G, K, N

Disposition Code B. Replaced part, dispose of according to company practices.

Disposition Code G. Discard removed part.

Disposition Code K. Old and new parts are interchangeable.

Disposition Code N. Old part will no longer be available for this application.

\*Refer to Section 1, Paragraph F for information regarding price and availability of parts.

S/N \_\_\_\_\_

# *Service Information Letter*

## *Certificate of Compliance*

PLEASE FILL IN THE REQUIRED DATA BELOW AND RETURN TO:

ISRAEL AIRCRAFT INDUSTRIES INTERNATIONAL, INC.  
P.O. BOX 10086  
WILMINGTON, DE 19850  
ATTN: Technical Publications

This is to certify that 1124 Model Westwind Aircraft Serial Number \_\_\_\_\_  
has complied with Garrett/Airesearch Service Bulletin No. 3213894-36-1419,  
"Pneumatic-Pressure Regulating and Shutoff Valve," announced in SIL No.  
1124-21-069.

Aircraft Registration No. \_\_\_\_\_

Airframe Total Time at Compliance \_\_\_\_\_ /Cycles: \_\_\_\_\_

Compliance Date \_\_\_\_\_ By \_\_\_\_\_  
Signature

OWNER:

ACCOMPLISHING AGENCY:

_____	_____
_____	_____
_____	_____
_____	_____

Please describe below any discrepancies found or difficulties encountered during compliance:

\_\_\_\_\_

\_\_\_\_\_

\_\_\_\_\_

\_\_\_\_\_

\_\_\_\_\_

\_\_\_\_\_

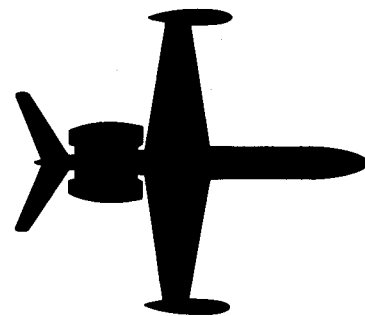

# **SERVICE INFORMATION LETTER**

---

---

SIL NO. 1124-21-078

REVISION 1

March 20, 1991

## **TRANSMITTAL SHEET**

This transmits Revision 1 to Service Information Letter No. 1124-21-078 dated May 4, 1990 titled, "Air Conditioning - 35 Degree Temp Sensor Connector - Reliability Improvements."

### **REASON FOR REVISION**

To announce a retrofit of the 35° Temperature Sensor from P/N 627482-1 to 627482-3 by Garrett Canada.

This is a COMPLETE REVISION, replace all pages affected by this revision.

### **LIST OF EFFECTIVE PAGES**

<b><u>PAGE NO.</u></b>	<b><u>DATE</u></b>
1 and 2	March 20, 1991

### **PREVIOUS REVISIONS OF SIL 1124-21-078**

None.

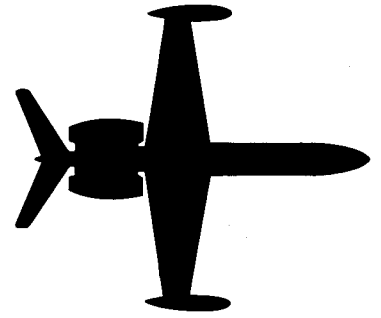

# SERVICE INFORMATION LETTER

SERVICE INFORMATION LETTER NO. 1124-21-078

May 4, 1990

**SUBJECT:** AIR CONDITIONING - 35 DEGREE TEMP SENSOR CONNECTOR - RELIABILITY IMPROVEMENTS

**EFFECTIVITY:** MODEL 1124/1124A WESTWIND, all serial numbers.

**A. REASON**

1. To reduce the effects of dissimilar metal corrosion on the contacts of temp sensor connector, P/J116 and ensure a more positive electrical connection.
- R 2. To announce a retrofit of the 35° Temperature Sensor from Part Number  
R 627482-1 to 627482-3 (IAI P/N 783649-3 ) by Garrett Canada.

**B. REFERENCES**

- 1124/1124A Westwind Maintenance Manual, Chapter 21-50-00.  
1124/1124A Westwind Wiring Diagram Manual, Chapter 21-00-01.  
R 1124/1124A Westwind Illustrated Parts Catalog, Chapters 21-20-00 and 21-60-00.

**C. PUBLICATIONS AFFECTED**

- 1124/1124A Westwind Maintenance Manual, Chapters 5-20-05 and 21-50-00.  
R 1124/1124A Westwind Illustrated Parts Catalog, Chapters 21-20-00 and 21-60-00.

**D. DESCRIPTION**

1. Perform a thorough visual inspection of P/J116, the 35 degree temp sensor plug and jack (A 10X magnifying glass is recommended). Check for evidence of pitting and corrosion of the male pins (temp sensor side) and for discoloration and/or deposits on the female contacts of the aircraft connector.

- (a) If pitting or corrosion is noted on the pins, attempt a thorough cleaning with a Freon spray cleaner and cotton swabs.
  - (b) Completely clean all corrosion deposits from the female connector using a Freon spray cleaner and toothpicks (or other acceptable non-abrasive tool for thorough cleaning of the female contacts).
2. Prior to reconnecting P/J116, pack the temp sensor plug with DC-4 compound (Dow-Corning). This compound will act as a moisture barrier and reduce the potential for dissimilar metal corrosion.

**NOTE:** Recommend the inspection and packing procedure be accomplished at every 150 hour inspection interval.

- R 3. To further preclude dissimilar metal corrosion, Garrett Canada will retrofit the  
R temp sensor with a new connector having gold-plated contacts, when  
R requested, in conjunction with repair action. An additional fee will be  
R charged for this retrofit.

R **NOTE:** Upon retrofit, the part number 627482-1 will be changed to part  
R number 627482-3. New orders should be for P/N 627482-3.



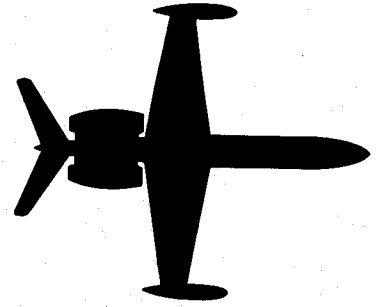

# SERVICE INFORMATION LETTER

---

SERVICE INFORMATION LETTER NO. 1124-21-085

December 27, 1990

**SUBJECT:** AIR CONDITIONING - 35°F TEMPERATURE CONTROL  
SENSOR INSTALLATION

**EFFECTIVITY:** MODEL 1124/1124A WESTWIND, all serial numbers.

**A. REASON**

To prevent thread damage of the 35°F temperature sensor or the mounting boss.

**B. REFERENCES**

1124/1124A Westwind Maintenance Manual, Chapter 21-50-00.

**C. PUBLICATIONS AFFECTED**

1124/1124A Westwind Maintenance Manual, Chapter 21-50-00.

**D. DESCRIPTION**

During installation of the 35°F temperature control sensor, an anti-seize compound conforming to MIL-A-907E, should be used on the threads for ease of installation and to prevent damage of the threads of the sensor or the mounting boss.

# 1124-WESTWIND

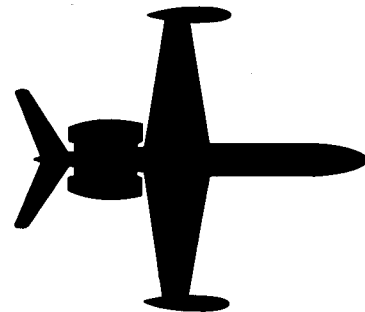

## SERVICE INFORMATION LETTER

SIL NO. 1124-22-004

December 3, 1984

SUBJECT: PILOT AND COPILOT ANNUNCIATOR PANEL INTERCONNECT PLUG WIRING.

EFFECTIVITY: MODEL 1124/1124A aircraft.

### A. REASON

- (1) Many aircraft were manufactured using letter or numbered interconnect plugs, without reflecting this production change in some of associated aircraft drawings. This has caused some confusion in system troubleshooting.
- (2) The following is a cross reference to convert connector pin numbers to letters, as well as letters to numbers, should you find this condition exists in your aircraft and/or effective drawings.

### B. PUBLICATIONS AFFECTED

1124/1124A Aircraft Wiring Manual and Engineering drawing package.

### C. DESCRIPTION

<u>CONNECTOR PIN NUMBER</u>	<u>PLUG D32D/J LETTER</u>	<u>PLUG D55P/J PLUG D255P/J</u>
1	A	R
2	-	P
3	-	N
4	-	M
5	B	I
6	-	K
7	C	A
8	D	B
9	E	C
10	-	D

December 3, 1984



SUBSIDIARY OF ISRAEL AIRCRAFT INDUSTRIES, LTD.  
BEN GURION AIRPORT, ISRAEL

SIL 1124-22-004  
Page 1 of 2

CONNECTOR PIN  
NUMBER

PLUG D32P/J  
LETTER

PLUG D55P/J  
PLUG D255D/J  
LETTER

11  
12  
13  
14  
15  
16  
17  
18  
19  
20  
21  
22  
23  
24  
25  
26  
27  
28  
29  
30  
31  
32  
33  
34  
35  
36  
37  
38  
39

-  
-  
F  
-  
G  
H  
-  
-  
-  
-  
-  
-  
J  
K  
L  
-  
-  
M  
N  
-  
P  
-  
R  
S  
-  
-  
T  
U  
V  
W

E  
F  
G  
H  
J  
K  
J  
L  
M  
S  
N  
P  
R  
S  
T  
U  
H  
G  
V  
W  
X  
Y  
Z  
A  
B  
C  
D  
E  
F

# SERVICE PUBLICATIONS

# revision notice

---

SIL NO. 1124-22-011  
Revision No. 1

February 17, 1986

SUBJECT: AIR DATA/COMPUTER AND ALTIMETER CERTIFICATION  
FOR 1124A.

EFFECTIVITY: MODEL 1124A, all serial numbers.

REASON FOR  
REVISION:

To expedite the receipt of Revision No. 3,  
SIL 1-80, to ALI-80( ) Barometric Altimeter/  
ADC-80( )/81( )/82( ) Air Data Computer.

Attached is a revised issue of ALI-80( ) Barometric Altimeter/  
ADC-80( ) Air Data Computer Service Information Letter 1-80  
titled, "Periodic Recertification of the ALI-80( ) Barometric  
Altimeter and ADC-8X( ) Air Data Computer according to Federal  
Aviation Regulation (FAR) Part 91.171", originally dated May  
15, 1980 and last revised November 20, 1984.

This revision clarifies the tests and specifications of FAR 43,  
Appendix E, Section (b) for field recertification.

Black bars in the margin indicate where changes have been made.  
This revised issue entirely replaces the original.



SUBSIDIARY OF ISRAEL AIRCRAFT INDUSTRIES LTD.  
BEN GURION AIRPORT, ISRAEL

SIL 1124-22-011  
Page 1 of 1

# 1124-WESTWIND

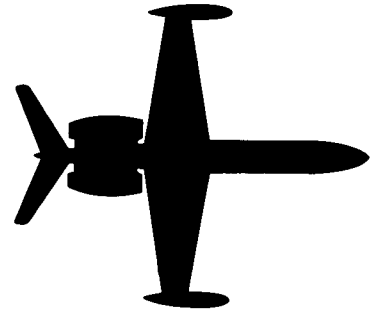

## SERVICE INFORMATION LETTER

---

---

SIL NO. 1124-22-011

December 21, 1984

SUBJECT: AIR DATA/COMPUTER AND ALTIMETER CERTIFICATION FOR  
1124A.

EFFECTIVITY: MODEL 1124A, all serial numbers

A. REASON

Attached is a copy of Rockwell-Collins SIL 1-80 Rev. No. 2 for the ADC-80K and ALI-80 system recertification in accordance with FAR 91.171.

This document details bench and in-aircraft recertification procedures, so you may use the method of your choice.



SUBSIDIARY OF ISRAEL AIRCRAFT INDUSTRIES, LTD.  
BEN GURION AIRPORT, ISRAEL

SIL 1124-22-011  
Page 1 of 1

161710-4880K

ALI-80() BAROMETRIC ALTIMETER (622-2292-XXX, 622-2701-XXX,  
622-3975-XXX, 622-4425-XXX, 622-6238-XXX)  
ADC-80() AIR DATA COMPUTER (622-2290-XXX, 622-4371-XXX, 622-4365-XXX,  
622-5206-XXX, 622-5465-XXX, 622-6233-XXX, 622-2704-XXX, 622-7576-XXX,  
622-7577-XXX, 622-8070-XXX)  
ADC-81() AIR DATA COMPUTER (622-4401-XXX)  
ADC-82() AIR DATA COMPUTER (622-6475-XXX, 622-8105-XXX, 622-8329-XXX)  
(P/O ADS-80()/81()/82() AIR DATA SYSTEM)

REVISION NO. 3  
TO  
SERVICE INFORMATION LETTER 1-80

PERIODIC RECERTIFICATION OF THE ALI-80() BAROMETRIC ALTIMETER AND  
ADC-80()/81()/82() AIR DATA COMPUTERS ACCORDING TO FEDERAL AVIATION  
REGULATION (FAR) PART 91.171

## INTRODUCTION

The Collins ADS-80()/81()/82() systems consist of a central Air Data Computer, which can be an ADC-80(), ADC-81(), or ADC-82(), and a set of instruments. The instruments only display the various parameters to the pilot. Due to the digital nature of the instruments and the means used to transmit the data to them, the instruments do not contribute significantly to the accuracy addressed by FAR 91.171. There are no requirements to test instruments with a computer and no requirements to keep instruments and computers together as matched pairs.

ALI-80() units are included in the FAR 91.171 recertification requirements only as a precaution since the total error potential addressed by FAR 91.171 resides in the computer.

## DETERMINATION OF RECERTIFICATION REQUIREMENT

To determine the required recertification date, examine the tags attached to the rear of the ALI-80() and the front (on the sloped surface below the handle) of the ADC-80()/81()/82(). The date on this tag indicates the date the unit was last certified. It must be recertified per FAR 91.171 within 24 calendar months of that date. The ALI-80() and ADC-80()/81()/82() are independently certified and are not a matched set.

## RECERTIFICATION

Altimeters and computers may be returned to Collins for FAR 91.171 recertification and, if necessary, repair. As an alternative, the following procedures may be used. If the procedures below are completed and the system fails to meet the accuracy required by FAR 91.171, the ADC-80()/81()/82() must be returned to Collins for repair. Generally, failure to meet FAR 91.171 accuracies will not be due to a defective altimeter.

**PROCEDURE 1 (Remove Equipment From Aircraft and Bench Certify)**

Any organization that can recertify other manufacturer's altimeters can recertify the ALI-80() Barometric Altimeter and ADC-80()/81()/82() Air Data Computers by using the following procedures:

**NOTE:** With the equipment interconnected as shown in Figure 1, the ADC-80()/81()/82() fault lamp will be ON. This is caused by the invalid configuration of the interconnect and does not affect the altitudes displayed on the ALI-80().

1. Remove the ALI-80() and ADC-80()/81()/82() from the aircraft and interconnect as shown in Figure 1.
2. Check the ALI-80 and ADC-80()/81()/82() accuracy as outlined in FAR Part 43, Appendix E, Section (b).

Paragraph (2) of Section (b) is applicable. The appropriate tests and specifications (as listed in Section (b) Paragraph (1) ) are as follows:

- (a) The tests of Section (b) (1) (i) Scale Error shall be conducted except that Table 1 shall be abbreviated as shown:

TABLE 1

ALTITUDE (FEET)	EQUIVALENT PRESSURE (INCHES OF MERCURY)	TOLERANCE ± (FEET)
-2,000	32.148	20
0	29.921	20
1,000	28.856	20
5,000	24.896	37
10,000	20.577	80
15,000	16.866	105
20,000	13.750	130
25,000	11.104	155
30,000	8.885	180
40,000	5.538	230
50,000	3.425	280
* 55,000	2.693	305

- (b) The tests of Section (b) (1) (ii) Hysteresis, Section (b) (1) (iii) After Effect, and Section (b) (1) (iv) Friction do not apply.

- (c) The test of Section (b)(1)(v) Case Leak shall be performed as written.

\* Applicable only to ALI-80L, CPN 622-6238-XXX; ADC-80L, CPN 622-6233-XXX; ADC-82L, CPN 622-8105-XXX.

- (d) The tests of Section (b) (1) (vi) Barometric Scale Error shall be conducted except that the pressure applied from the pitot/static tester shall be an altitude of 8,230 feet or 22.030 inches of mercury and Table IV shall be amended as shown.

TABLE IV

<u>BARO SET</u> <u>(INCHES OF HG)</u>	<u>ALI-80() READING</u> <u>(FEET)</u>	<u>TOLERANCE</u> <u>± (FEET)</u>
22.06	30	25
23.00	1130	25
23.98	2230	25
24.99	3330	25
26.03	4430	25
26.52	4930	25
27.02	5430	25
27.52	5930	25
28.03	6430	25
28.54	6930	25
28.96	7330	25
29.49	7830	25
30.03	8330	25
30.47	8730	25
31.02	9230	25
31.47	9630	25
32.03	10130	25

3. If the system fails to meet the tolerances shown in FAR's, the ALI-80() and/or the ADC-80()/81()/82() must be returned to Collins for repair.

NOTE: If the system is found to be out of tolerance, perform the ALI-80() Self Test. If the ALI-80() passes the self test, the ADC-80()/81()/82() is probably out of tolerance and should be returned for repair.

4. If the system passed the FAR 91.171 testing, relabel the ALI-80() and ADC-80()/81()/82(), using label CPN 634-1340-001, with the date of the test and maximum altitude. Reinstall the units in the aircraft.
5. Perform the tests in Procedure 2, Steps 6, 7, 8, 9, and 10.



**PROCEDURE 2 (Recertify Equipment While Installed in the Aircraft)**

The following procedure, along with a Pitot/Static tester, will enable an organization to comply with FAR Part 91.171.

**NOTE:** The Pitot/Static tester must contain a barometric altimeter that has been calibrated to lab standard as specified by FAR 91.171.

1. Connect Pitot/Static tester as shown in Figure 2 or Figure 3.
2. Check ALI-80() and ADC-80()/81()/82() accuracy as outlined in FAR Part 43, Appendix E, Section (b).

Paragraph (2) of Section (b) is applicable. The appropriate tests and specifications (as listed in Section (b) Paragraph (1) ) are as follows:

- (a) The tests of Section (b) (1) (i) Scale Error shall be conducted except that Table 1 shall be abbreviated as shown:

TABLE 1

<u>ALTITUDE (FEET)</u>	<u>EQUIVALENT PRESSURE (INCHES OF MERCURY)</u>	<u>TOLERANCE ± (FEET)</u>
-2,000	32.148	20
0	29.921	20
1,000	28.856	20
5,000	24.896	37
10,000	20.577	80
15,000	16.866	105
20,000	13.750	130
25,000	11.104	155
30,000	8.885	180
40,000	5.538	230
50,000	3.425	280
* 55,000	2.693	305

- (b) The tests of Section (b) (1) (ii) Hysteresis, Section (b) (1) (iii) After Effect, and Section (b) (1) (iv) Friction do not apply.

- (c) The test of Section (b)(1)(v) Case Leak shall be performed as written.

\* Applicable only to ALI-80L, CPN 622-6238-XXX; ADC-80L, CPN 622-6233-XXX; ADC-82L, CPN 622-8105-XXX.

- (d) The tests of Section (b) (1) (vi) Barometric Scale Error shall be conducted except that the pressure applied from the pitot/static tester shall be an altitude of 8,230 feet or 22.030 inches of mercury and Table IV shall be amended as shown:

TABLE IV

<u>BARO SET (INCHES OF HG)</u>	<u>ALI-80() READING (FEET)</u>	<u>TOLERANCE ± (FEET)</u>
22.06	30	25
23.00	1130	25
23.98	2230	25
24.99	3330	25
26.03	4430	25
26.52	4930	25
27.02	5430	25
27.52	5930	25
28.03	6430	25
28.54	6930	25
28.96	7330	25
29.49	7830	25
30.03	8330	25
30.47	8730	25
31.02	9230	25
31.47	9630	25
32.03	10130	25

3. Adjust the Pitot/Static tester to zero airspeed and local elevation. Remove power from the air data system.
4. If the system passed, relabel the ADC-80()/81()/82() and ALI-80 using CPN 634-1340-001 with the date of the test and maximum altitude tested.

**NOTE:** It may be necessary to disconnect and remove either unit from the aircraft for relabeling. After completion, make appropriate connection, and proceed to step 6.

5. If the system fails to meet the tolerances shown in FAR's, the ADC-80()/81()/82() and/or ALI-80 must be returned to Collins for repair.
6. Apply power to the ADS-80()/81()/82() System. Per FAR 91.171, perform pitot-static leak test and altitude reporting system intergration test. Disconnect pitot/static tester.

The intent of the above procedure is to allow recertification of serviceable units that meet tolerances shown in FAR's. (Continue with the following tests.)

SERVICE INFORMATION LETTER 1-80

**NOTE:** Push-to-test operation can be initiated locally with the TEST switch on the ADS-80()/81()/82() front panel or remotely from the cockpit TEST switch. The following operation is identical to both.

7. Push and hold TEST switch and the following will occur.
  - (a) Data to be displayed is inhibited.
  - (b) Test stimulus begins.
  - (c) Air data computer (FCS/ADC) valid to flight control system is inhibited.
  - (d) ADC valid (relay) contacts open (become invalid).
  - (e) Amber lamp on air data computer (ADC) front panel lights, signifying initial computer fault due to self test initialization.

8. If test is successful (in approximately 0.5 second), the following occurs:
  - (a) Amber lamp on ADC goes out, green lamp on ADC lights.
  - (b) ADC valid (relay) contacts close (become valid).
  - (c) FCS/ADC valid to flight control system remains inhibited (invalid).
  - (d) Data to displays remains inhibited.

**NOTE:** If test is unsuccessful, the amber lamp on ADC front panel remains ON.

9. Release the TEST switch and the following occurs:
  - (a) Test stimulus is removed.
  - (b) All lamps are extinguished that were turned ON during the test ADS-80()/81()/82() lamps.
  - (c) Data transmissions to displays are restored.
  - (d) FCS/ADC valid to flight control system is restored.
  - (e) ADC valid (relay) contacts remain closed (become valid).
10. ALI-80() push-to-test operation - this button exercises the internal self-test circuits and operates as follows:
  - (a) Push and hold TEST button.
  - (b) Transponder output is inhibited.
  - (c) Altitude flag comes into view in approximately 0.5 second.
  - (d) Altitude pointer slews to the nearest 750-foot mark on the 0-to -1,000-foot scale.
  - (e) Release TEST button.
  - (f) Transponder output re-established.
  - (g) Altitude pointer remains to actual altitude display.
  - (h) Flag retracts.

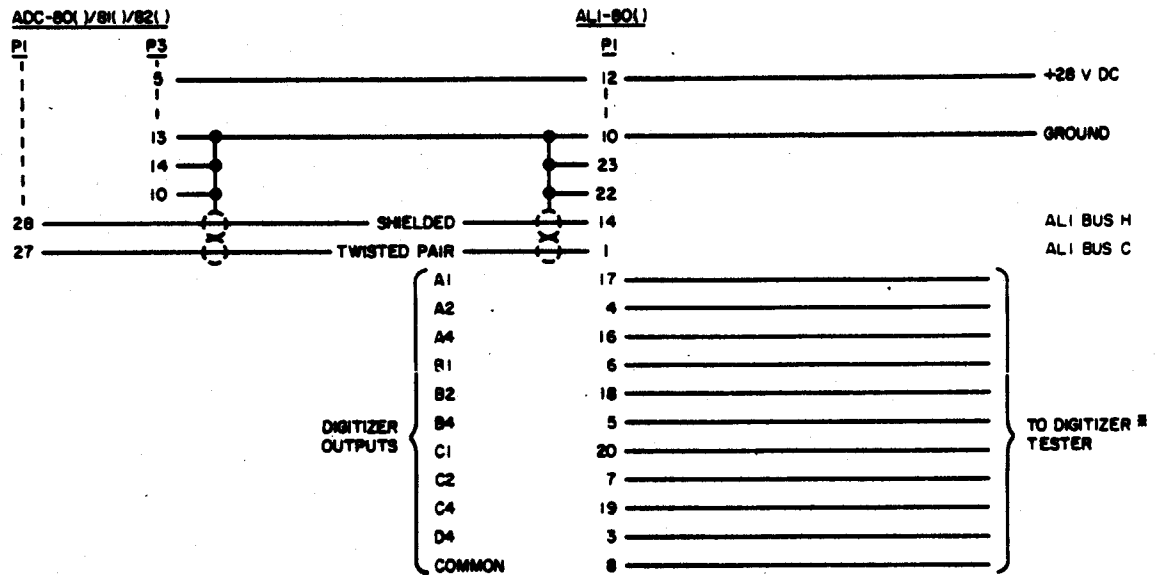

\* NOT REQUIRED FOR FAR 9471 TESTING.

INTERCONNECT CABLE  
CONNECTOR INFORMATION

UNIT	QTY	DESCRIPTION
ADC-80( )/81( )/82( )	1	CONNECTOR KIT (CPN 629-7806-005)
	7	CONTACTS (CPN 327-2514-010)
ALI-80( )	1	CONNECTOR, 25 PIN ITT CANNON ON DBC-25PAA (CPN 371-0922-030)
	17	SNAP-IN CRIMP SOCKET CONTACTS ITT CANNON PN D10238-5 (CPN 371-0946-060)

**NOTE:** IF MORE CONNECTOR INFORMATION IS REQUIRED, REFER TO ADS-80( ) AIR DATA SYSTEM INSTRUCTION BOOK (523-0767654) OR ADS-81/82 AIR DATA SYSTEM INSTRUCTION BOOK (523-0772425).

ALI-80( )/ADC-80( )/81( )/82( )  
Interconnect Diagram  
Figure 1

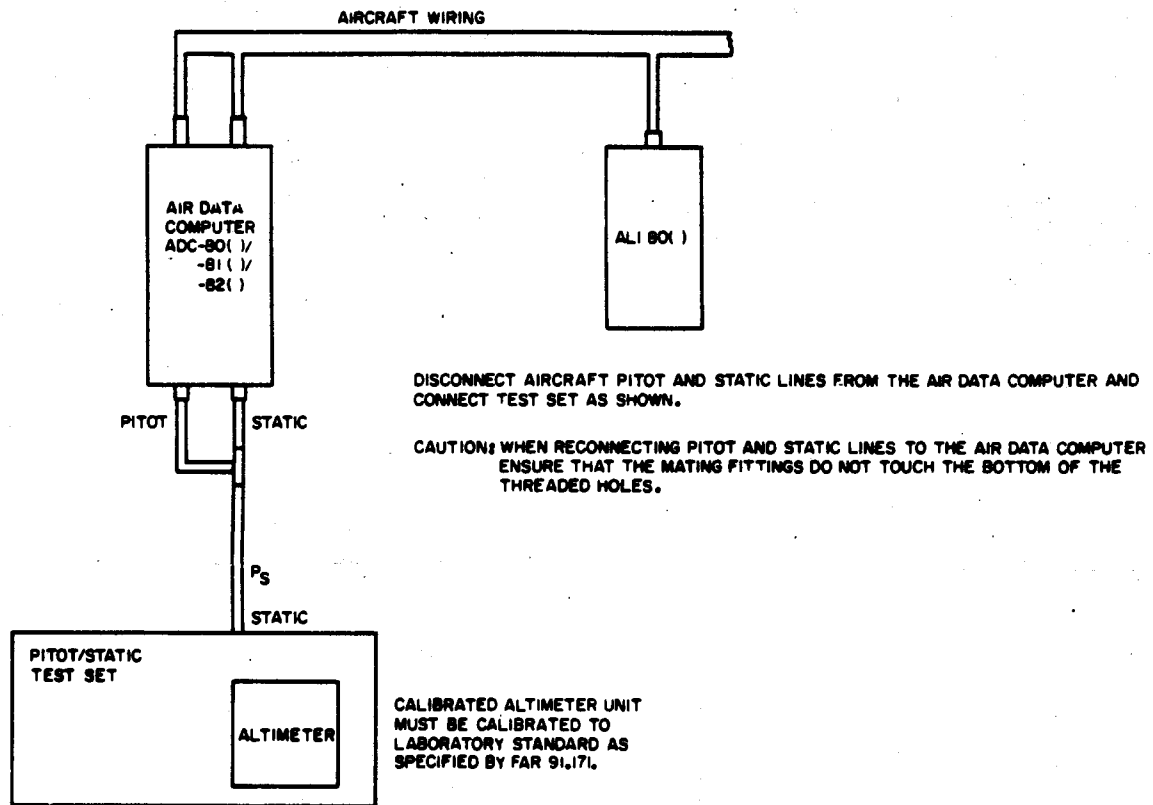

Pitot/Static Test Set  
Connection Diagram  
Figure 2

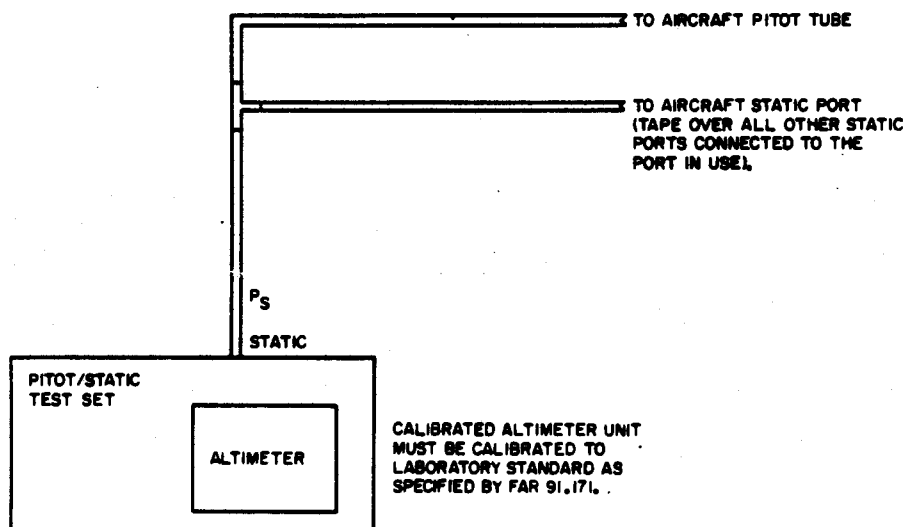

Pitot/Static Test Set  
Connection Diagram  
Figure 3

# 1124-WESTWIND

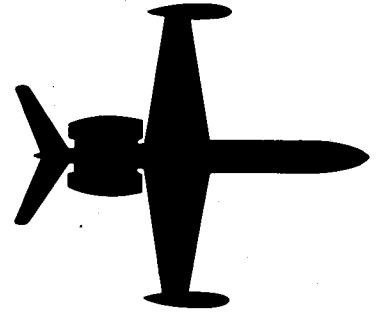

## SERVICE INFORMATION LETTER

---

---

SIL NO. 1124-22-038

April 2, 1985

SUBJECT: VERTICAL GYRO ADJUSTMENT PROCEDURE

EFFECTIVITY: 1124/1124A WESTWIND, all serial numbers.

### A. REASON

1. To provide instructions to properly level the vertical gyro(s), with consideration of the different gyro mounts and locations. These procedures eliminate errors due to visual parallax and electro-mechanical instrument misalignment.
2. Performance of these procedures will reduce radar stabilization errors and the necessity to cross trim the aircraft aileron and rudder to maintain Flight Director and Autopilot track.
3. Cross trimming of aileron and rudder may create a condition where the vertical gyro will precess to an invalid level condition. This artificial level may in turn create the need for additional cross trim, to a point where the Flight Control System can no longer maintain a track and the radar antenna can no longer stabilize.

### B. REFERENCES

1124/1124A Maintenance Manual Chapter 22-01-00 or 22-11-00.  
1124/1124A Wiring Diagram Manual, Chapters 22-10-02, 22-10-03,  
and/or 34-40-01.

### C. PUBLICATIONS AFFECTED

1124/1124A Maintenance Manual, Chapter 22-01-01 or 22-11-00.



SUBSIDIARY OF ISRAEL AIRCRAFT INDUSTRIES, LTD.  
BEN GURION AIRPORT, ISRAEL

SIL 1124-22-038  
Page 1 of 4

D. INSTRUCTIONS

1. Accurately level the aircraft to within  $\pm \frac{1}{4}$  degree. Use of a calibrated, adjustable level (such as a propeller protractor) and a rigid straightedge is recommended.

NOTE

Use of existing inclinometer and/or a standard bubble level will not permit proper accuracy.

- a. Use jacking method described in Maintenance Manual Chapter 8-00-01, or, as an alternative, vary the MLG strut and/or tire pressure. For this procedure, the strut pressure method is recommended.
  - b. As an additional check of longitudinal level, use the cabin seat rail tracks. Should there be a difference in angle as referenced to center top of fuselage, divide the angular difference by (2) and use this result as level. Record angle readings.
  - c. As an additional check of lateral level, measure across the inner seat rails in mid-cabin. Should there be a difference as referenced to the inner cockpit seat rails, divide the angular difference by (2) and use this result as level.
2. Apply external power to aircraft; Battery, Inverter, and Avionics Master switches ON.
    - a. Permit vertical gyro(s) to erect, as indicated by the Attitude Indicator "Gyro" or "Attitude" flag retraction.
    - b. Level each ADI Inclinometer. Observe ball closely to eliminate parallax.
    - c. Remove Pilots Attitude Indicator, and Copilots if so equipped.
  3. To monitor longitudinal (pitch) axis, connect an AC millivoltmeter across the pitch X-Y inputs to each ADI:
    - a. For 1124, ADI 329B84, plug DN18A pins 29 and 30.

- b. For 1124, ADI-85, plug DN18J1 pins a and b.
  - c. Shim gyro as required to reach a null (minimum voltage).
  - d. Repeat for copilots gyro, if so equipped.
4. To monitor lateral (roll) axis, connect the AC millivoltmeter across the roll X-Y inputs to each ADI:
    - a. For 1124, ADI 329B84, plug DN18A pins 26 and 27.
    - b. For 1124A, ADI85, plug DN18J1 pins W and X.
    - c. Shim gyro as required to reach a null. Record reading.
    - d. Repeat for copilots gyro, if so equipped. Record reading.
  5. For 1124A aircraft, and those 1124s modified with the "skew" plate mounting, reference Step 4 above:

CAUTION

If the jacking method is used to level the aircraft, exercise extreme caution in the following steps to prevent the aircraft from slipping off the jack pads.

- a. Loosen the (3) skew plate bolts to permit adjustment.
- b. Raise the aircraft nose to a minimum of 4° deck angle. DO NOT exceed the limits of jack pad cups. The higher the angle, the greater the final accuracy.
- c. Adjust skew plate for a roll axis null. Repeat for copilots gyro if so equipped. Lock skew plate(s).
- d. Lower nose of aircraft to original level point. Verify by reference to original level point angle reading. Voltmeter should record same roll null voltmeter reading as obtained in Step 4.c above.
  1. If voltmeter reading is in error by more than 50 millivolts, repeat Step 4.c and reshim gyro for null.
  2. Repeat for copilots gyro, if so equipped.



6. Secure vertical gyro. Stud mounting nuts for the Collins 332D-11A/T must not exceed 4 foot-pounds torque.
7. Reassemble aircraft and inspect systems as required.

# 1124-WESTWIND

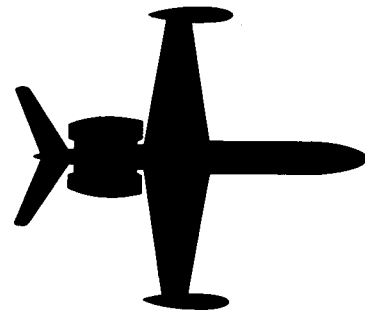

## SERVICE INFORMATION LETTER

---

---

SERVICE INFORMATION LETTER NO. 1124-22-039

April 2, 1985

SUBJECT: VERTICAL GYRO IMPROVEMENTS

EFFECTIVITY: MODEL 1124/1124A WESTWINDS, all serial numbers.

### A. REASON

- (1) To inform that the Collins 332D-11T Vertical Gyro has been approved as a replacement for the existing 332D-11A or Sperry VG-14/VG-14A units.
- (2) Of special interest is the elimination of very high speed control vibrations, primarily in level flight, caused by vertical gyro noise.
  - (a) Existing 332D-11A units may be upgraded to an improved version by incorporating Collins Service Bulletins 332D-11A -22 (5/15/83); -23 (3/14/84); and -24 (4/18/84).
- (3) Upon reinstallation of the vertical gyro, refer to Service Information Letter 1124-22-038 for proper leveling procedures.
- (4) Should you desire to convert your Sperry VG-14/VG-14A units to the Collins system, it is recommended that the nose mounted gyro(s) be remounted using the "skew plate" system as used in Model 1124A aircraft.
  - (a) The "skew plate" modification will further reduce radar stabilization errors and autopilot altitude loss in steep turns. The remounting modification, which also reduces the difference in ADI displays during climb, descent, and steep turns will accept dual vertical gyros on a common mounting plate.



SUBSIDIARY OF ISRAEL AIRCRAFT INDUSTRIES, LTD.  
BEN GURION AIRPORT, ISRAEL

SIL 1124-22-039  
Page 1 of 2

SERVICE INFORMATION LETTER 1124-22-039

- (b) The "skew plate" modification will be available at a later date as an Optional Service Bulletin, and will cover the necessary mechanical details as well as the wiring and plug changes required to convert the Sperry systems.

# 1124-WESTWIND

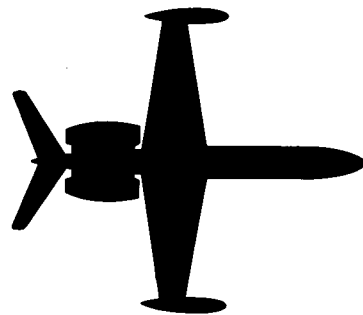

## SERVICE INFORMATION LETTER

---

---

SIL NO. 1124-22-042

April 2, 1985

SUBJECT: HORIZONTAL TRIM ACTUATOR RESPONSE TIME

EFFECTIVITY: MODEL 1124/1124A WESTWINDS, all serial numbers.

A. REASON

To simplify troubleshooting of defective trim actuator and autopilot components.

B. REFERENCES

None

C. PUBLICATIONS AFFECTED

1124/1124A Maintenance Manual Chapters 27-40-00 and 22-01-00 or 22-11-00 as applicable.

D. INSTRUCTIONS

1. Apply external power to aircraft, Battery, Avionics #1, and Inverter #1 switches ON. Permit vertical gyro to erect, as indicated by the retraction of the ADI "Attitude" or "Gyro" flag.
2. Manually trim the actuator (normal mode) to one stop. Operate in opposite direction until stop is reached. Time the interval from stop to stop.
  - a. For 1124, 16 seconds  $\pm$  2 is normal.
  - b. For 1124A, 14 seconds  $\pm$  2 is normal.
  - c. Repeat for opposite stop, time interval should be the same.



SUBSIDIARY OF ISRAEL AIRCRAFT INDUSTRIES, LTD.  
BEN GURION AIRPORT, ISRAEL

SIL 1124-22-042  
Page 1 of 2

SERVICE INFORMATION LETTER NO. 1124-22-042

2. Ensure flaps at  $0^{\circ}$ , engage autopilot, allow yoke to fall full nose down. Command autopilot pitch up with thumb wheel on autopilot controller. Begin timing when yoke begins to move back.
  - a. For 1124, 190 seconds + 20 is normal. Collins SB42 must be installed in 562C5 A/P amplifier. See 1124 SL WW-2451 Part A.
  - b. For 1124A, 50 seconds  $\pm$  5 is normal.
3. Repeat Step 2 above. Disengage autopilot, allow yoke to fall forward. Engage autopilot, and command pitch down on autopilot controller.
  - a. Time intervals the same as in Step 2.
4. For the 1124 only, lower the flaps to  $12^{\circ}$  and repeat Steps 2 and 3 above.
  - a. Time interval 70 seconds  $\pm$  5 is normal.

# 1124-WESTWIND

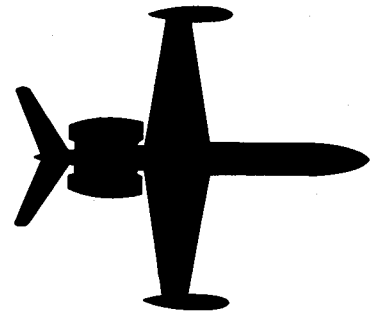

## SERVICE INFORMATION LETTER

---

---

SIL NO. 1124-22-045B

February 7, 1986

This service information letter supersedes SIL No. 1124-22-045 dated April 5, 1985 and SIL No. 1124-22-045A in their entirety.

SUBJECT: SIX-POLE RELAY CONTACT FAILURES AND REPLACEMENT INFORMATION

EFFECTIVITY: MODEL 1124/1124A WESTWINDS, all serial numbers

A. REASON

The relays used in avionics and some electrical systems may exhibit intermittent operation when the circuit being controlled has very low current levels, such as the vertical gyro, compass, HSI and VLF synchro and steering signals.

B. PUBLICATIONS AFFECTED

Model 1124/1124A Illustrated Parts Catalog

C. DESCRIPTION

1. It is a normal procedure to use a relay from another position to verify a defective relay during troubleshooting. While this is a correct and advisable procedure, it is necessary to return the "test" relay to its original socket and oriented in the same direction as it was removed in the event reversed mounting is possible.

Failure to return a relay to its original position may lead to a premature failure if left in the new position on which work is being performed. This is due to the fact that any relay, once in service, will condition its contact sets to the current flowing through the contacts. This current will normally be different for each contact set, even in the same system; a given

SIL No. 1124-22-045B  
Page 1 of 4



SUBSIDIARY OF ISRAEL AIRCRAFT INDUSTRIES, LTD.  
BEN GURION AIRPORT, ISRAEL

contact set in the relay itself will likely be subjected to a different current condition if inserted in a new location.

As an example, assume a given relay contact set is being used as a low current switch. Inserting this relay contact set in a new position, switching to a higher current, will soon result in contact arcing and/or pitting, with resultant intermittent operation.

The reverse is also true. Using a contact set "conditioned" for high current use in a position requiring low-level current switching will result in an open or intermittent contact, even though a normal "continuity test" will show the relay to be normal.

2. The original round four-pole relay P/N UN312585 has been superseded first by P/N U26A1G118AS-2, then by the current P/N U26A8G18S-4. The socket P/N UN314567 remains unchanged. These relays are becoming increasingly difficult to obtain, should replacement be required.
  - a. Deutsch P/N H26WDK18S or P/N V26WDK18S have been approved as replacements. Use of the type "V" is recommended, due to improved vibration characteristics. These relays conform to MIL-R-5757-XXX that may be cross-referenced to other manufacturers.
  - b. It will be necessary to replace the existing relay sockets, using Deutsch P/N 6403-10 or equivalent to conform to the new relay pin and indexer spacing.
  - c. Refer to Figure 1 for cross-reference to socket pin numbers from the original "H", "B" and "F" designations. These socket pin numbers are valid for all above relay part numbers.
3. The original P/N ESO-D4AD two-pole "crystal can" relay has been superseded, first by P/N DJ26FL1P6ASF26 and then by P/N DJ26L1P6AS. The socket P/N HRCW-1M remains unchanged.

Should replacement be required, the Deutsch P/N DJ26L1P6AS is available or an alternate vendor may be used by specifying MIL SPEC M39016/6-105L equivalents.

It will be not be necessary to change the original relay sockets.

4. There have been reports of various switching transients in the avionics systems causing audible "clicks" in the speaker or headphones. These transients may also cause erratic operation of other on-board systems, such as "blinking" or blanking of digital displays and the momentary appearance of a random system flag.

These problems have been traced to the relays discussed in (3) and (4) above, in that these relays may not have an arc-suppressor clamp diode across the coil. The relay coil itself is not malfunctioning.

The problem, once the relay or relays causing the transient have been identified, may be corrected by connecting a diode (P/N 1N645) across the offending relay coil.

Connect the diode cathode (banded end) to the C1 contact of the "round" relay or the X1 contact of the "crystal can" relay. These pins are also identified by a dot. The diode anode connects to C2 or X2 as appropriate.

- (a) 1124 operators please reference SIL No. 21 dated August 31, 1982 for additional information.

5. The "round" type UN or U26 relay replacements (type H or V, as desired) are available with internal diode suppression, P/N HS26WDK18S or VS26WDK18S, as applicable.

Internal diode suppression is also available for the "crystal can" relays. The latest P/N DJ26L1P6AS becomes P/N DJS26L1P6AS with the internal diode. Other vendors have similar diode suppressed relays; however, the MIL-R-M39016/6 specification does not contain the necessary diode.



Letter Designation	Pin Number	Letter Designation	Pin Number
C1	1 (dotted)	B3	11
C2	2	F4	12
F1	3	H4	13
H1	4	B4	14
B1	5	F5	15
F2	6	H5	16
H2	7	B5	17
B2	8	F6	18
F3	9	H6	19
H3	10	B6	20

Figure 1. Letter and Pin Designation Numbers

# 24-WESTWIND

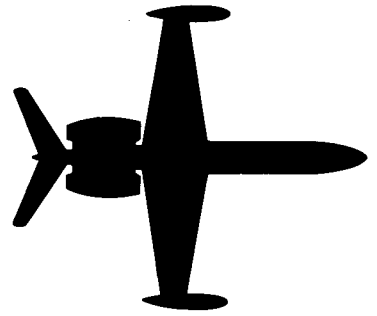

## SERVICE INFORMATION LETTER

---

---

SERVICE INFORMATION LETTER NO. 1124-22-065A

October 31, 1986

(This Service Information Letter No. 1124-22-065A dated October 31, 1986 supersedes and cancels 1124 SIL No. 07 dated June 12, 1981, Revision No. 1 dated October 15, 1982 and SIL 1124-22-065 dated February 14, 1986.)

SUBJECT: AUTOPILOT - TO REDUCE ROLL AXIS CYCLING

EFFECTIVITY: MODEL 1124A WESTWIND, all serial numbers.

### A. REASON

To reduce the periodic roll axis cycling ("wing walk") to an acceptable level.

### B. REFERENCES

1. Collins Service Bulletin G to the Autopilot Computer APC-80.
2. 1124/1124A Maintenance Manual, Chapter 27-00-00, Temporary Revision No. 27-3 dated Aug 15/86, pages 1 and 2.
3. 1124/1124A Service Bulletin No. 1124-34-067 dated January 8, 1986 and Service Information Letter No. 1124-22-038 dated April 2, 1985.

### C. DESCRIPTION

1. Collins Service Bulletin G describes the changes required to the APC-80 gain control switch settings necessary to further stabilize the aircraft roll axis.

These switches are located inside the APC-80; therefore, it is recommended that resetting the switches be accomplished by an authorized Collins dealer to avoid errors in switch identification and settings.



SUBSIDIARY OF ISRAEL AIRCRAFT INDUSTRIES, LTD.  
BEN GURION AIRPORT, ISRAEL

SIL 1124-22-065A  
Page 1 of 2

SERVICE INFORMATION LETTER NO. 1124-22-065A

2. Ensure control system is free of excess friction by performing tests described in the MM, Chapter 27-00-00.
3. For further improvement of roll response, it is suggested that the provisions of SB 1124-34-067 be incorporated, especially to ensure proper vertical gyro shock mounting and "skew" plate clamping.
  - (a) Ensure your vertical gyro system(s) is properly leveled. Refer to SIL No. 1124-22-038 for proven procedures.
4. Perform autopilot servo capstan tests as follows:
  - (a) Using external power, inverters on, allow gyros to erect and engage A/P-YD. Neutralize system (no flight director modes) with pitch/roll command knobs, with control yoke, wheel and rudder pedals in center of travel.
  - (b) Operate control wheel once rapidly to left or right stop and immediately release. Wheel should overshoot once and return to center. No response or very slow response would indicate a "soft" capstan.

NOTE: DO NOT cycle controls "back and forth" prior to release for test. This creates an artificial condition that looks like a proper response.
  - (c) Neutralize system, repeat for pitch and yaw. Should this check indicate a soft capstan, contact your Collins dealer for corrective action. It will be necessary to remove the servo and disassemble the servo mount/capstan from the aircraft to readjust the system. Adjustment requires special tooling and is normally accomplished at a Collins Factory Repair Station.

# 1124-WESTWIND

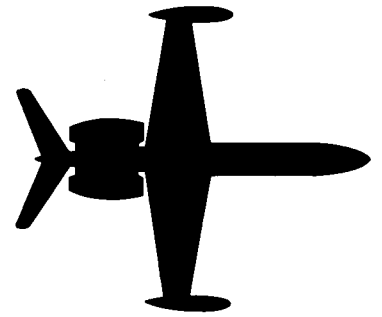

## SERVICE INFORMATION LETTER

---

---

SIL NO. 1124-22-056

August 12, 1985

SUBJECT: INADVERTENT ANNUNCIATOR LAMP CONTROL

EFFECTIVITY: MODEL 1124A WESTWIND, S/N 295 and subs.

A. REASON

To eliminate interference with AP/FD annunciator lamp dimming when lateral mode is selected on copilot FGP80 mode selector.

B. REFERENCES:

MODEL 1124-1124A Wiring Diagram Manual, Chapter 22-10-07.

C. PUBLICATIONS AFFECTED

MODEL 1124/1124A Wiring Diagram Manual, Chapter 22-10-07.

D. DESCRIPTION

1. Turn aircraft power on.
2. Turn on Lamp Test, select dim position.
3. Select any lateral mode on copilot's Flight Guidance Panel (FGP).
  - (A) If annunciator lamps go to full bright condition disconnect wire from FGP plug, B236 J1, pin 31 and cap near the plug.
  - (B) If annunciator lamps remain dim, no action required.



SUBSIDIARY OF ISRAEL AIRCRAFT INDUSTRIES, LTD.  
BEN GURION AIRPORT, ISRAEL

SIL 1124-22-056  
Page 1 of 1

# 1124-WESTWIND

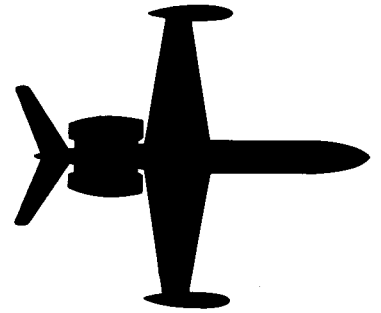

## SERVICE INFORMATION LETTER

---

---

SIL NO. 1124-22-068

November 7, 1986

(This Service Information Letter No. 1124-22-068 dated November 7, 1986 supersedes and cancels 1124 SIL No. 7 dated June 12, 1981 and Revision No. 1 dated October 15, 1982.)

**SUBJECT:** AUTOPILOT - TO REDUCE ROLL AXIS CYCLING AND IMPROVE VERTICAL MODE PERFORMANCE

**EFFECTIVITY:** MODEL 1124 WESTWIND, all serial numbers.

### A. REASON

1. To reduce the periodic roll axis cycling ("wing walk") to an acceptable level.
2. To reduce the vertical mode (MACH, IAS) cycling to an acceptable level.

### B. REFERENCES

1. Collins Service Bulletin 44 to Autopilot Amplifier 562C5; and  
1124 Service Letter WW-2455 dated March 26, 1980, Part B.
2. Collins Service Bulletin 10 to Air Data Control 590A-3K1; or  
Collins Service Bulletin 24 to Air Data Control 590A-3H/K; and  
1124 Service Letter WW-2451 dated February 28, 1980, Parts A and/or B.
3. 1124/1124A Maintenance Manual, Chapter 27-00-00, Temporary Revision 27-3 dated Aug 15/86, pages 1 and 2.



SUBSIDIARY OF ISRAEL AIRCRAFT INDUSTRIES, LTD.  
BEN GURION AIRPORT, ISRAEL

SIL 1124-22-068  
Page 1 of 3

SERVICE INFORMATION LETTER NO. 1124-22-068

4. Service Bulletin No. 1124-34-067 dated January 8, 1986  
Service Information Letter No. 1124-22-039 dated April 2, 1985  
Service Information Letter No. 1124-22-038 dated April 2, 1985

C. DESCRIPTION

1. Collins Service Bulletin 44 to the 562C5 describes changes required to improve autopilot roll axis vertical gyro response. This modification must be accomplished by an authorized Collins dealer.

Inspect aircraft for compliance with SL WW-2455, Part B and perform the described modification if not previously accomplished.

These changes may be installed individually; however, both must be accomplished for maximum results.

2. Collins Service Bulletin 10 to the 590A-3K1 OR Service Bulletin 24 to the 590A-3H/K as applicable to your aircraft describe changes required to improve and stabilize aircraft response to IAS and MACH HOLD vertical mode commands. These modifications must also be accomplished by an authorized Collins dealer.

When the modifications are incorporated, the 590A-XXX Air Data Control part number will change to a -009 status to specifically identify the model 1124 aircraft configuration and modification status as follows:

<u>Model</u>	<u>New Part Number</u>
590A-3K1	622-4394-009
590A-3H	792-6672-009
590A-3K	622-3204-009

- (a) For exchange purposes, the new part number may be installed as applicable to your aircraft. Inspect aircraft for compliance with SL WW-2451, Parts A and B, and perform the described modification(s) if not previously accomplished.
- (b) Part B also describes the necessary steps to interchange a 590A-3K1 Air Data Control with previous models, should this be desired for further improved control in all vertical modes.

These changes may be installed individually; however, all must be accomplished for maximum results.

SERVICE INFORMATION LETTER NO. 1124-22-068

3. Ensure control system is free of excess friction by performing tests described in Maintenance Manual Chapter 27-00-00.
4. For further improvement of roll response, it is suggested that the provisions of SIL No. 1124-22-039 and SB No. 1124-34-067 be incorporated. This modification will also reduce altitude loss (when in ALT HOLD or ALT TRACK modes) during high roll bank angles.
  - (a) Ensure your vertical gyro system(s) is properly leveled. Refer to SIL No. 1124-22-038 for proven procedures.
5. Perform autopilot servo capstan tests as follows:
  - (a) Using external power, inverters on, allow gyros to erect and engage A/P-YD. Neutralize system (no flight director modes) with pitch/roll command knobs, with control yoke, wheel and rudder pedals in center of travel.
  - (b) Operate control wheel once rapidly to left or right stop and immediately release. Wheel should overshoot once and return to center. No response or very slow response would indicate a "soft" capstan.

NOTE: DO NOT cycle controls "back and forth" prior to release for test. This creates an artificial condition that looks like a proper response.
  - (c) Neutralize system, repeat for pitch and yaw. Should this check indicate a soft capstan, contact your Collins dealer for corrective action. It will be necessary to remove the servo and disassemble the servo mount/capstan from the aircraft to readjust the system. Adjustment requires special tooling and is normally accomplished at a Collins Factory Repair Station.

November 7, 1986

SIL 1124-22-068  
Page 3 of 3

# 1124-WESTWIND

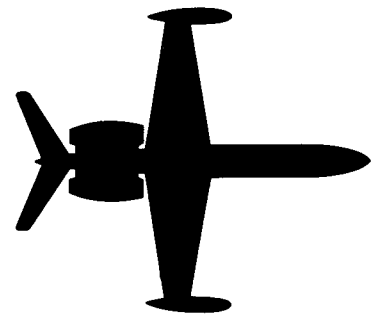

## SERVICE INFORMATION LETTER

SERVICE INFORMATION LETTER NO. 1124-22-075

DECEMBER 7, 1989

SUBJECT: AUTO PILOT - VERTICAL GYRO PRECESSION

EFFECTIVITY: MODEL 1124 WESTWIND, all serial numbers equipped with Honeywell/Sperry Model VG-14A, part number 7000622-901 Vertical Gyro.

**A. REASON:**

To locate and remove for exchange or repair certain serial number VG-14A gyros which may have had faulty liquid levels installed during production or maintenance that can cause slow erection, sluggish operation, and/or precession in pitch or roll axis.

**B. REFERENCE:**

Honeywell Alert Service Bulletin 21-1989-191 Revision 1 dated November 20, 1989 attached.

**C. PUBLICATION AFFECTED:**

None

**D. DESCRIPTION:**

Should your gyro have been replaced or repaired from July 1988 to Date, refer to ASB21-1989-191 attached for details.

Be advised the serial number listings are those involving Honeywell delivered units only. In the event your transaction involved an agency other than Honeywell, please contact them for details.

RT  
SN 81075206

LEFT  
PN 2587193-43  
SN 81095980

C-14A



# Honeywell

Attached is Revision 1 to the VG-14A Vertical Gyro Service Bulletin No. A7000622-34-03 (Pub. No. 21-1989-191).

This revision adds the suffix letter "K" to Section 2, Accomplishment Instructions paragraph 2.B., adds an additional unit serial number to the first page of Table 1, and corrects the part number in Section 3, Material Information.

Revision bars have been added to indicate the changed text. Please replace the Bulletin in your possession with the attached revised Bulletin.

Highlights (21-1989-191, Revision 1)  
Page 1 of 1  
Nov 20/89

# ALERT SERVICE BULLETIN

21-1989-191

NAVIGATION  
ATTITUDE REFERENCE SYSTEM  
VG-14A Vertical Gyro  
Modification D

Improves Reliability by Replacing Tilt Switches (Liquid Levels) With Potential of Cracking and Leaking During Operation

## 1. Planning Information

### A. Effectivity

This Service Bulletin is applicable to the VG-14A Vertical Gyro, Part No. 7000622-901. It applies to units with serial numbers listed in Table 1, Section 2, Accomplishment Instructions, not having the letter D marked out in the MOD block of the identification plate.

In addition to the above, all units overhauled or repaired, which had liquid levels replaced by non-Honeywell facilities from July 1988 through October 1989 are affected by this Bulletin.

### B. Reason

This modification improves the reliability of the listed units by inspection and replacement (if necessary) of any defective liquid levels, that have the potential of cracking and leaking during operation, with new liquid levels in which the problem has been eliminated.

### C. Description

This modification directs the opening of the listed units, inspection for type of liquid levels installed and replacement of the suspect liquid levels if present.

### D. Compliance

Accomplishment of this modification is mandatory only on units with serial numbers listed in Table 1, Section 2, Accomplishment Instructions, as the safety of the aircraft is affected. Honeywell Inc. Authorized Repair Facilities will incorporate this modification on all applicable units, including shelf units. At the discretion of the repair facility, MOD D may be identified on units with serial numbers prior to 89096443 that are in compliance with the instructions in this Bulletin but are not in Table 1 of Section 2, Accomplishment Instructions.

### E. Approval

FAA/TSO approval granted.

## SERVICE BULLETIN

### 1. F. Manpower

This modification may be accomplished and unit tested in approximately 7.0 man-hours. When this modification is performed concurrently with other repair and testing operations, approximately 3.0 man-hours are required.

### G. Material - Cost and Availability

Parts and materials required to accomplish the modification described in this Bulletin are available from Honeywell Inc. Refer to Section 3, Material Information, for part numbers, part descriptions, and ordering information.

### H. Tooling - Price Availability

No special equipment is required to accomplish the work described in this Bulletin.

### I. Weight and Balance

No change.

### J. Electrical Load Data

Not affected.

### K. References

- (1) Required to perform this Bulletin.

Component Maintenance Manual (CMM), Pub. No. 09-3224-02, dated 1 June 1979, revised 1 March 1981.

- (2) Used as source information for this Bulletin. (Not required to perform the Bulletin.)

Engineering Drawing No. 7000622, Revision K.

### L. Other Publications Affected

Component Maintenance Manual, Pub. No. 09-3224-02, will be revised as a consequence of this Bulletin. Testing is not affected.

# SERVICE BULLETIN

## 2. Accomplishment Instructions

- A. Gain access to the liquid levels (240, IPL Figure 3 and 70, IPL Figure 4) by accomplishing DISASSEMBLY paragraphs 3.A.(1) through B.(1), using CMM (References 1.K.(1)).
- B. Inspect liquid levels referenced in paragraph 2.A. of this Bulletin. If the liquid levels have serial numbers beginning with the letters "EG" or it is obscured so that identification is not possible, proceed to paragraph 2.C. If the levels have serial numbers beginning with the letter "S" or ending with the letter "K" proceed to paragraph 2.D.
- C. Replace the liquid levels referenced in paragraph 2.A. of this Bulletin in accordance with procedures in REPAIR paragraph 3.D.(3) using CMM (References 1.K.(1)).
- D. Assemble unit in accordance with ASSEMBLY paragraphs 3.E.(1) through (22) using CMM (References 1.K.(1)) as needed, and paragraphs 5.A. and B.
- E. Mark out the letter D in the VG-14A Vertical Gyro identification plate.
- F. Test the VG-14A Vertical Gyro in accordance with References 1.K.(1).

## SERVICE BULLETIN

(NEW PRODUCTS)

LRU	SHIPDT	SER
7000622-901	880824	88076281
7000622-901	890223	88076282
7000622-901	890114	88076283
7000622-901	881228	88076284
7000622-901	890223	88076285
7000622-901	890106	88076286
7000622-901	881228	88076287
7000622-901	890106	88076288
7000622-901	890106	88076289
7000622-901	890106	88076290
7000622-901	890110	88076291
7000622-901	881228	88076292
7000622-901	881228	88076293
7000622-901	890106	88076294
7000622-901	890106	88076295
7000622-901	881228	88076296
7000622-901	881111	88096297
7000622-901	890413	88096298
7000622-901	881228	88096299
7000622-901	881111	88096300
7000622-901	881013	88096301
7000622-901	881111	88096302
7000622-901	881228	88096303
7000622-901	881013	88096304
7000622-901	890106	88096305
7000622-901	881013	88096306
7000622-901	881111	88096307
7000622-901	881111	88096308
7000622-901	881013	88096309
7000622-901	881013	88096310
7000622-901	881111	88096311
7000622-901	890118	88106312
7000622-901	890118	88106313
7000622-901	890118	88106314
7000622-901	890118	88106315
7000622-901	890118	88106316
7000622-901	890118	88106317
7000622-901	890413	88106318
7000622-901	890118	88106319
7000622-901	881214	88106320
7000622-901	890118	88106321
7000622-901	890118	88106322
7000622-901	881214	88106323
7000622-901	890118	88106324
7000622-901	890329	88106325
7000622-901	890329	88106326
7000622-901	890329	88116327
7000622-901	890329	88116328
7000622-901	890329	88116329
7000622-901	890323	88116330

LRU	SHIPDT	SER
7000622-901	890712	88116331
7000622-901	890315	88116332
7000622-901	890620	88116333
7000622-901	890315	88116334
7000622-901	890626	88116335
7000622-901	890315	88116336
7000622-901	890315	88116337
7000622-901	890328	88116338
7000622-901	890323	88116339
7000622-901	890315	88116340
7000622-901	890329	88116341
7000622-901	890523	88126342
7000622-901	890413	88126344
7000622-901	890712	88126345
7000622-901	890523	88126346
7000622-901	890413	88126347
7000622-901	890613	88126348
7000622-901	890413	88126350
7000622-901	890413	88126351
7000622-901	890413	88126352
7000622-901	890425	88126353
7000622-901	890523	88126354
7000622-901	890424	88126355
7000622-901	890523	88126356
7000622-901	890515	89016357
7000622-901	890413	89016358
7000622-901	890413	89016359
7000622-901	890413	89016360
7000622-901	890515	89016361
7000622-901	890515	89016362
7000622-901	890515	89016363
7000622-901	890515	89016364
7000622-901	890413	89016365
7000622-901	890413	89016366
7000622-901	890515	89016367
7000622-901	890523	89016368
7000622-901	890613	89016369
7000622-901	890515	89016370
7000622-901	890613	89016371
7000622-901	890524	89026372
7000622-901	890613	89026373
7000622-901	890613	89026374
7000622-901	890613	89026375
7000622-901	890613	89026376
7000622-901	890523	89026377
7000622-901	890524	89026378
7000622-901	890613	89026379
7000622-901	890613	89026380
7000622-901	890524	89026381
7000622-901	890712	89026382
7000622-901	890613	89026383

LRU	SHIPDT	SER
7000622-901	890524	89025384
7000622-901	890613	89026385
7000622-901	890710	89036387
7000622-901	890814	89036388
7000622-901	890710	89036389
7000622-901	890710	89036390
7000622-901	890710	89036391
7000622-901	890710	89036392
7000622-901	890821	89036393
7000622-901	890710	89036394
7000622-901	890630	89036396
7000622-901	890712	89046397
7000622-901	890712	89046398
7000622-901	890710	89046399
7000622-901	890814	89046400
7000622-901	890710	89046402
7000622-901	890814	89046403
7000622-901	890710	89046404
7000622-901	890814	89046405
7000622-901	890814	89046406
7000622-901	890814	89046407
7000622-901	890814	89046408
7000622-901	890814	89046409
7000622-901	890814	89046410
7000622-901	890802	89056411
7000622-901	890724	89056412
7000622-901	890713	89056413
7000622-901	890821	89056414
7000622-901	890821	89066417
7000622-901	890630	89066420
7000622-901	890701	89066421
7000622-901	890814	89076423
7000622-901	890804	89076424
7000622-901	890814	89076425
7000622-901	890814	89076427
7000622-901	890901	89076428
7000622-901	890927	89076429
7000622-901	890901	89076430
7000622-901	890927	89076431
7000622-901	890901	89076432
7000622-901	890901	89076433
7000622-901	890901	89076434
7000622-901	890901	89076436
7000622-901	890901	89086426
7000622-901	890901	89086437
7000622-901	890929	89086438
7000622-901	890929	89086439
7000622-901	890928	89086440
7000622-901	890928	89086441
7000622-901	891005	89086442
7000622-901	890901	89096435

VG-14A LRU Applicable Unit Serial Numbers  
Table 1

## SERVICE BULLETIN

(REWORKED)

LRU	SER	LOC	DATE
7000622-901	79050405		880729
7000622-901	79060455		880812
7000622-901	79100804	43	890202
7000622-901	80011116	1	881223
7000622-901	80041479	1	890801
7000622-901	80061707		880617
7000622-901	80091945	1	880925
7000622-901	80102151	43	890117
7000622-901	80102194	1	890721
7000622-901	81012375	1	881114
7000622-901	81022578	35	890410
7000622-901	81022624	43	890606
7000622-901	81063103	38	880831
7000622-901	81073170		880916
7000622-901	81073176		880623
7000622-901	81083311	1	881007
7000622-901	81083352		881006
7000622-901	81083353	1	881006
7000622-901	81093478		880624
7000622-901	81113628		880607
7000622-901	82074265		880602
7000622-901	83064476		881104
7000622-901	83124725	1	881118
7000622-901	84014705	1	881117
7000622-901	84024757		880624
7000622-901	84054823		880907
7000622-901	84074993	1	880926
7000622-901	84095097	36	890907
7000622-901	84105112	1	890726
7000622-901	84115188	1	890109
7000622-901	85045311	43	890105
7000622-901	86035537	1	880911
7000622-901	86075839	43	890217
7000622-901	86115757		880725
7000622-901	87035821	38	890819
7000622-901	87035823		880717
7000622-901	87128111	35	890729
7000622-901	88026178		880826
7000622-901	88046233	1	890403

VG-14A LRU Applicable Unit Serial Numbers  
Table 1 (cont)

## SERVICE BULLETIN

### 3. Material Information

The following parts are required to modify each VG-14A Vertical Gyro in accordance with this Bulletin:

New Part No.	Qty	Description
4020077	2	Switch, Tilt (Liquid Level) (FSCM 55939, PN 077)

For pricing and additional information, please contact:

Honeywell Inc.  
Sperry Commercial Flight Systems Group  
1830 Industrial Avenue  
Wichita, Kansas 67216

ATTN: Replacement Parts

TEL: (316) 522-8172

TLX: 417-444

FAX: (316) 522-2693

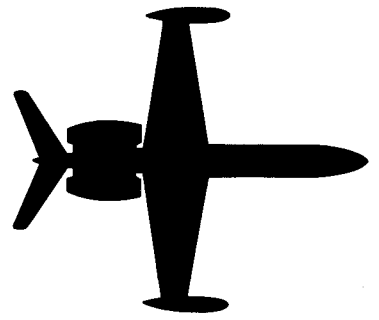

# SERVICE INFORMATION LETTER

SERVICE INFORMATION LETTER NO. 1124-22-076

March 26, 1990

**SUBJECT:** AUTO PILOT - ALTITUDE PRESELECT ERRORS

**EFFECTIVITY:** MODEL 1124A WESTWIND, all serial numbers.

**A. REASON**

To prevent unannounced preselect altitude capture errors.

**B. REFERENCE**

Rockwell-Collins Service Bulletin 6 to the PRE-80A/B Preselector.

**C. PUBLICATIONS AFFECTED**

Aircraft Serialized Equipment List

**D. DESCRIPTION**

Referenced service bulletin modifies the PRE-80 warning system to alert the operator should the system capture an altitude other than that selected.

This Service Bulletin creates a new part number, 622-9462-016 for the PRE-80. This new part number is approved for use on Model 1124A Westwind Aircraft. When modification is accomplished, update the aircraft Illustrated Parts Catalog and Equipment List, in addition to any computerized maintenance service in use.

Contact your Collins dealer for further details.



# 1124-WESTWIND

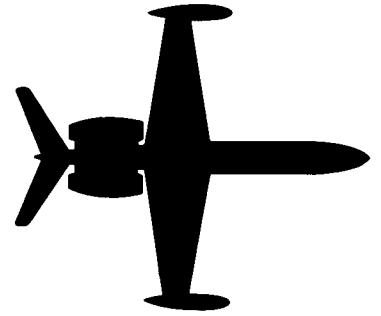

## SERVICE INFORMATION LETTER

---

---

SIL NO. 1124-23-016

January 28, 1985

SUBJECT: STATIC WICK AND BASE BONDING TESTS

EFFECTIVITY: MODEL 1124/1124A WESTWIND, all serial numbers.

A. REASON

To provide an effective method of determining condition of various types of Static Wicks on aircraft and bonding of static wick bases to airframe.

B. PUBLICATIONS AFFECTED:

1124/1124A Maintenance Manual Chapter 23-60-00.

C. EQUIPMENT REQUIRED

- (1) Digital or bridge-type ohmmeter for low resistance bonding tests.
- (2) Low current (less than 1 amp) 500 VDC Megohmmeter for static wick resistance tests.

D. DESCRIPTION

CAUTION

Use of Megohmmeter of high voltage type could be hazardous. Avoid personal contact with attachment leads, and do not use in the presence of volatile fumes or substance.



SUBSIDIARY OF ISRAEL AIRCRAFT INDUSTRIES, LTD.  
BEN GURION AIRPORT, ISRAEL

SIL 1124-23-016  
Page 1 of 4

SERVICE INFORMATION LETTER NO. 1124-34-016

1. For original equipment, plastic body or flexible sheathed type wicks, connect Megohmmeter ground (-) lead to wick base. Connect positive (+) lead to metal pin or exposed tip of static wick.
2. For replacement "Carbon" type wicks, connect Megohmmeter ground (-) lead to wick base, connect positive (+) lead to a plain steel wool or wet sponge pad. Bring pad into contact with tip of static wick.
3. Normal Readings:
  - (a) For original, long, "trailing" type wicks, 8 to 100 megohms.
  - (b) For carbon "trailing" type wicks, 8 to 150 megohms.
  - (c) For original, short, "tip" type wicks, 5 to 60 megohms.
  - (d) For carbon "tip" wicks, 6 to 120 megohms.
4. As each wick is tested, rotate wick around the point at which the wick enters the housing. No resistance change shall be noted.
5. Replace defective static wicks that fail above tests.
  - (a) You will note an "average" value among most wicks installed on the aircraft. Those wicks exceeding this "average" value are suspect.
  - (b) With good wicks, this "average" value will be toward the low resistance side of permissible tolerance.

E. WICK BASE BONDING

1. Measure from each static wick base to adjacent airframe. A reading of 0.5 ohm (0.1 ohm is normal) or less indicates a good bond.
  - (a) Readings in excess of 0.5 ohm will require the wicks and/or base be removed and rebonded.
  - (b) See installation procedures in Service Bulletin No. 1124-23-016.

F. CONTROL SURFACE BONDING

- (1) Measure across each control surface hinge bond braid (aileron, flap, elevator and rudder). Do not measure from bond attach bolts, but adjacent to them.
  - (a) A reading in excess of 0.1 ohm (0.01 ohm is normal) will indicate a poor bond. Remove bond strap (replace if broken or frayed) and clean attachment area, Iridite P/N 14-2, reassemble and test.

G. DIVERTER STRIP BONDING

- (1) Radome: Locate forward edge of DIVERTER strips (6) places. Measure from this point to fuselage structure behind radome.
  - (a) A reading of 0.5 ohm or more indicates a defective bond. Repair and/or rebond diverter strip as necessary.
  - (b) Should your radome be equipped with the two piece diverter (with the attachment bolt from outer diverter to inner diverter to aircraft) measure from outer to inner diverter strip. A reading in excess of 0.5 ohm indicates a defective bond at the interconnection bolt. Repair and/or bond as necessary.
  - (c) Those aircraft equipped with the one piece diverter strips should inspect the aft edge of strip where it folds around radome.
    - (1) Excessive sanding or buffing will thin the wrap-around edges, causing diverter strip to crack and causing poor, or intermittently no bond at all.
      - (a) Replace cracked diverter strips.
- (2) Tip tank tail cones.
  - (a) Repeat procedures in step G.1 above for all tip tank tail cone diverter strips.
- (3) To ensure proper contact to airframe, polish and Iridite all diverter strip attach points on airframe.

SERVICE INFORMATION LETTER NO. 1124-34-016

- (a) Do not polish new diverter strips at airframe contact points, as this removes the conductive coating. This coating will tarnish, with no effect to conductivity.
- (b) If diverter strips have been polished, then:
  - (1) Use Penetrox conductive grease at each attach point, after periodic diverter strip polishing; OR

Insert mounting screw through diverter strip mounting hole, and install proper hole size external tooth lockwasher (MS35335 type B) over diverter strip screw inside dome or tail cone.

- (a) Use solder sparingly to prevent separation of diverter strip from fiberglass. Do not fill up gripping teeth of lock washer.
  - (b) File gripping teeth of washer, as little as possible, to permit dome (or cone) to slide over airframe.
- (c) Repeat bonding test as in Paragraph G.1. above.

END

# 24-WESTWIND

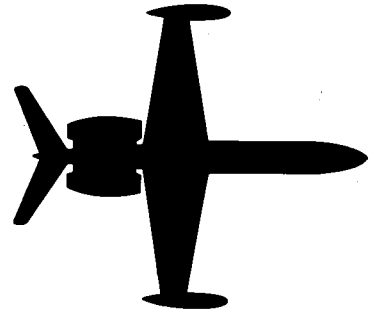

## SERVICE INFORMATION LETTER

---

SIL NO. 1124-23-044

April 2, 1985

SUBJECT: TO PREVENT FAILURE OF STEREO SYSTEM AND "L" PAD  
CABIN VOLUME CONTROLS

### EFFECTIVITY:

1. Part (1): Model 1124/1124A WESTWINDS, with stereo systems employing "L" pad level control at output of high power stereo or booster.
2. Part (2): Model 1124 WESTWIND S/N's 354-384, 386, 391, 1124A WESTWIND S/N 351-384 except 353, 356.

### A. REASON

1. Part (1): "L" pads with inadequate power ratings for use in high power stereo systems will cause degradation of the stereo audio quality to speakers and phones, and may fail due to overheating.
2. Part (2): Stereo "L" pad level control connections improper causing stereo audio degradation.

### B. REFERENCES

1124/1124A Wiring Diagram Manual 23-30-01, 23-50-05.

### C. PUBLICATIONS AFFECTED

1124/1124A Wiring Diagram Manual 23-30-01, 23-50-05.

### D. DESCRIPTION

#### PART I

1. When failure of the stereo "L" pad occurs, or to preclude these failures, perform the procedures listed.



SUBSIDIARY OF ISRAEL AIRCRAFT INDUSTRIES, LTD.  
BEN GURION AIRPORT, ISRAEL

SIL 1124-23-044  
Page 1 of 3

- a. Locate and gain access for removal of "L" pad.
- b. Label removed wires for connection to new "L" pad.
- c. Replace "L" pad with Mallory Type LL-8, a dual 8 ohm 15 watt audio level control, in the event this part number control is not presently installed.
  - (1) It will probably be necessary to modify the LL-8 mounting bushing to permit clearance between the passenger control panel and the aircraft skin.
- d. Reconnect wires to Mallory Type LL-8 as follows:
  - (1) Ensure pad was originally wired correctly.
  - (2) Front segment of removed "L" pad same as LL-8. Pin 1 to pin 1, pin 2 to pin 2, pin 3 to pin 3.
  - (3) From rear segment of removed "L" pad connect pin 1 to pin 13, pin 2 to pin 12 and pin 3 to pin 11.
- e. Check stereo for normal operation, balance and control.
- f. Reassemble aircraft and return to service.

PART II

1. Reference Wiring Diagram Manual 23-30-01. Use following procedure for proper connections to L-pad. Do not remove wire unless so instructed.
  - a. Locate L-pad and gain access to terminal on L-pad.
  - b. Remove wire #5RZ502A24B from terminal 3 on L-pad.
    - (1) S/N 386 remove wire #5RZ302B22B from terminal 11.
  - c. Remove wire #5RZ503A24R from terminal 1 and reconnect wire #5RZ502A24B to terminal 1.
    - (1) S/N 386 - Remove wire #5RZ303B22R from terminal 13 and reconnect wire #5RZ302B22B to terminal 13.
  - d. Connect wire #RZ503A24R to terminal 3.

SERVICE INFORMATION LETTER NO. 1124-23-044

- (1) S/N 386 - Connect wire #5RZ303B22R to terminal 11.
- e. Check stereo for proper operation, balance and control.
- f. Reassemble aircraft and return to service.

# 24-WESTWIND

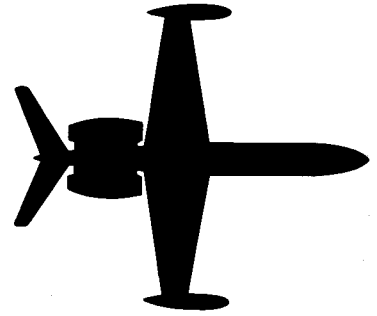

## SERVICE INFORMATION LETTER

---

SIL NO. 1124-23-047

April 8, 1985

SUBJECT: COLLINS HF220 SYSTEM IMPROVEMENTS

EFFECTIVITY: MODEL 1124/1124A WESTWINDS, all serial numbers with HF220 or provisions installed.

A. REASON

1. To prevent improper frequency selector operation due to noise from other systems or when HF transmitter is in use. This problem appears as a change in selected frequency, or, you are unable to select a desired frequency.
2. To enable frequency readout digits to dim, and/or prevent HF220 from causing NAV/COM digit dimming problems.

B. REFERENCES

1124/1124A Wiring Diagram Manual, Chapter 23-10-01.

C. PUBLICATIONS AFFECTED

1124/1124A Wiring Diagram Manual, Chapter 23-10-01.

D. DESCRIPTION

1. Ensure CTL220 Collins Service Bulletin 1 and 2 installed.



SUBSIDIARY OF ISRAEL AIRCRAFT INDUSTRIES, LTD.  
BEN GURION AIRPORT, ISRAEL

SIL 1124-34-047  
Page 1 of 2



2. Replace the existing unshielded Tune Data wiring with MIL W-16878D #22 AWG twisted pair shielded wire in the following combinations:
  - (a) CTL pin A to TCR pin 35 (wire #RL22A24) and CTL pin B to TCR pin 29 (wire #RL18A24) with one twisted pair.
  - (b) CTL pin C to TCR pin 30 (wire #RL19A24) and CTL pin P to TCR pin 31 (wire #RL20A24) with a second twisted pair.
  - (c) Terminate the shields from both pairs above to CTL pin Y.
  - (d) At the TCR, terminate and insulate each shield separately.
3. At the CTL, ensure wire #RL78A24 connects from CTL pin c to terminal strip T161 pin 5 (for 1124A) or T156 pin 12<sup>-</sup> (for 1124). If wire is disconnected, or does not exist, connect as above.
  - (a) Cut, cap, and stow any wire from CTL pin D. You may find this pin presently going to T161 or T156, use if required in Step 2 above.

# 24-WESTWIND

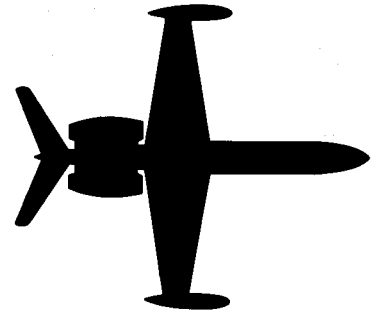

## SERVICE INFORMATION LETTER

---

SIL NO. 1124-23-048

April 8, 1985

SUBJECT: AIRCRAFT MICROPHONES AND COM UNIT ADJUSTMENT

EFFECTIVITY: MODEL 1124/1124A WESTWINDS, all serial numbers.

### A. REASON

To provide the operator with guidelines to prevent poor transmitter operation such as noisy, weak, squeals, and "splattering" on frequencies other than those desired.

### B. DESCRIPTION

1. Standard carbon type microphones deteriorate with age and moisture absorption. For this reason, ensure your hand mics, if of the carbon or a non-adjustable transistorized "dynamic" type are working properly. These mics are easily bench tested against known standards.
2. Most VHF and HF com units are adjusted for a standard mic audio input for proper modulation and power output. These adjustments must be made on the bench using a detector and oscilloscope to observe the transmitter carrier power and modulation. System adjustments will vary but most have "mic input level," "clipping," and "power" adjustments or an equivalent. Use equipment vendor maintenance manuals for correct procedure and adjustment identification.
  - a. These adjustments are best made using your own, known good, non-adjustable hand microphones.



SUBSIDIARY OF ISRAEL AIRCRAFT INDUSTRIES, LTD.  
BEN GURION AIRPORT, ISRAEL

SIL 1124-23-048  
Page 1 of 2

- b. Always recheck the adjustments at a reduced DC input level (22 volts) after adjustment at the normal 27.5 volts. Reset "clipping" and "power" adjustments as needed to prevent distortion and/or carrier power "drop outs."

NOTE

It is always wise to sacrifice some transmitter power in favor of the proper modulation envelope, in the long run you will talk further, clearer; and reduce the possibility of transmitter failure. You will always be able to maintain minimum rated transmitter power if the unit is operating properly. This is especially true for HF single-sideband operation.

3. Once the transmitters have been properly set for the "standard" input, adjust each dynamic type microphone (hand held or boom type) to equal the output of the "standard" microphone as observed on the oscilloscope. Be sure the boom microphones are in your normal position for pickup.
  - a. Also check the oxygen mask microphones in these tests.
4. Now that you have a "matched" system, you can adjust any replacement microphones (refer to vendor instructions) by using transmit headphone sidetone and setting your new microphone output level for the same sidetone volume. Keeping the headphone volume control set low will permit you to hear small changes in volume.

# SERVICE PUBLICATIONS

# revision notice

---

SIL NO. 1124-23-049  
Revision No. 1

July 31, 1985

SUBJECT: CTL 20/30 COM/NAV CONTROL INTERCHANGEABILITY

EFFECTIVITY: MODEL 1124A WESTWIND, all serial numbers  
except 239.

REASON FOR

REVISION: To change a cross-reference in paragraph B.2.,  
and D.4.(a). and 6.(a).

B. REFERENCES

2. Service Bulletin No. 1124-23-041 titled  
"Bypass of CTL(XX) Control Head Volume  
Controls."

D. DESCRIPTION

4. Compatible CTL-20 controls would be a -009,  
gray panel.
  - (a) If the aircraft has been modified per  
SB 1124-23-041, the -003 (black) or  
-001 (gray) controls may be used.  
These CTL-20 units do not contain  
volume controls.
6. Compatible CTL-30 controls would be a  
-077, gray panel.
  - (a) If the aircraft has been modified  
per SB 1124-23-041, the -67 (black)  
or -065 (gray) controls may be used.  
These CTL-30 units do not contain  
volume controls.

SIL 1124-23-049  
Page 1 of 1



SUBSIDIARY OF ISRAEL AIRCRAFT INDUSTRIES LTD  
BEN GURION AIRPORT, ISRAEL

# 24-WESTWIND

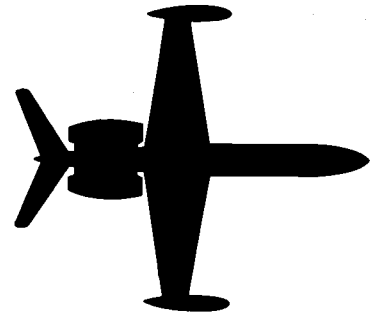

## SERVICE INFORMATION LETTER

---

SIL NO. 1124-23-049

April 26, 1985

SUBJECT: CTL 20/30 COM/NAV CONTROL INTERCHANGEABILITY

EFFECTIVITY: MODEL 1124A WESTWIND, all serial numbers except 239.

### A. REASON

1. To inform operators of the difference in lighting requirements for CTL-XX control "TRANSMIT" and "TUNE" indicators, and precautions to be observed should it be necessary to replace the original control head.
2. To provide operators with alternate part number CTL controls should original part number units not be available.

### B. REFERENCES

1. Model 1124/1124A Wiring Diagram Manual Chapters:  
23-20-01  
23-20-02  
34-50-01  
34-50-03
2. Service Bulletin No. 1124-23-030 titled "Bypass of CTL (XX) Control Head Volume Controls."

### C. PUBLICATIONS AFFECTED

None

### D. DESCRIPTION

1. CTL controls are originally supplied with "TRANSMIT" and "TUNE" lamps of the same voltage as the aircraft panel lighting (5VDC).



SUBSIDIARY OF ISRAEL AIRCRAFT INDUSTRIES, LTD.  
BEN GURION AIRPORT, ISRAEL

SIL 1124-23-049  
Page 1 of 3

2. Controls which have been modified to replace these lamps with 28V lamps should have a decal, stating "28V ANNUN LAMP", installed on the control cover.
  - (a) If a control does not have the decal, and you are unsure of the lamp voltage, it will require disassembly of the control front panel to identify lamp P/N 682 (5VDC) or 6839 (28VDC). This should be accomplished only by a qualified technician.
3. For CTL-20 controls, original P/N 622-4523-011 (black with 5 VDC lamps and volume control).
  - (a) A/C S/N 295 through 377. These aircraft use a 400 ohm 3 watt resistor for lamp voltage reduction.
  - (b) A/C S/N 380 and subs use a 28 VDC "TRANSMIT" lamp, and must have decal attached.
4. Compatible CTL-20 controls would be a -009, gray panel.
  - (a) If the aircraft has been modified per SB 1124-23-030, the -003 (black) or -001 (gray) controls may be used. These CTL-20 units do not contain volume controls.
  - (b) Ensure any replacement CTL-20 has the correct "TRANSMIT" lamp installed as described in paragraph 3. above.
5. For CTL-30 controls, original P/N 622-4524-079 (black with 5VDC lamps and volume control).
  - (a) A/C S/N 295 through 390. These aircraft use a 400 ohm 3 watt resistor for lamp voltage reduction.
  - (b) A/C S/N 392 and subs use a 28VDC "TUNE" lamp, and must have decal attached.
6. Compatible CTL-30 controls would be a -077, gray panel.

- (a) If the aircraft has been modified per SB 1124-23-030, the -067 (black) or -065 (gray) controls may be used. These CTL-30 units do not contain volume controls.
  - (b) Ensure any replacement CTL-30 has the correct "TUNE" lamp installed as described in paragraph 5. above.
7. Extreme caution must be used when replacing a CTL-20/30 because of the lamp change.
- (a) Use of a 28VDC lamp will result in a dim or inoperative lamp when installed in place of a 5VDC lamp CTL.
  - (b) Use of a 5VDC lamp will result in lamp failure and damage to the CTL when installed in place of a 28VDC lamp CTL.

# 1124-WESTWIND

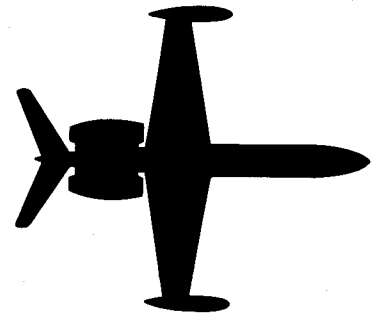

## SERVICE INFORMATION LETTER

---

---

SIL NO. 1124-23-060

January 10, 1986

SUBJECT: COMMUNICATIONS - AUDIO - SIDETONE ADJUSTMENT PROCEDURES

EFFECTIVITY: MODEL 1124/1124A WESTWINDS, all serial numbers

A. REASON

To provide advanced maintenance manual revision information on how to identify audio configurations and establish a means for proper adjustment of audio inputs/outputs of aircraft audio system.

B. REFERENCES

1124/1124A Wiring Diagram Manual, Chapters:

23-50-01	23-50-03
23-50-02	23-50-04

1124/1124A Maintenance Manual, Chapter 23-50-00 SIL 1124-23-048

C. PUBLICATIONS AFFECTED

1124/1124A Maintenance Manual, Chapter 23-50-00 will be revised to include this side-tone adjustment procedure.

D. DESCRIPTION

1. Comply with Service Information Letter No. 1124-23-048.
2. External Power, aircraft battery and master switches and Avionics Master switches (if so equipped) ON.
3. Tune and verify a VOR, LOC or ADF receiver identifier. Once observed, return all pilot and copilot audio speaker/phone switches to OFF.



SUBSIDIARY OF ISRAEL AIRCRAFT INDUSTRIES, LTD.  
BEN GURION AIRPORT, ISRAEL

SIL 1124-23-060  
Page 1 of 3



4. Select VHF COM 1, VHF COM 2 and HF (if so equipped) on pilot's MIC selector switch. Depress pilot's PTT, observe sidetone in pilot speaker (not affected by SPKR VOL control) and pilot's headsets (volume controlled by PHONE VOL control).
5. Note if sidetone also appears in copilot speaker. Select copilot audio switch for identifier observed above to SPKR. If identifier is muted during transmit, but is audible when PTT is released, set cockpit speaker sidetone adjustment located on 346B-3 control center to desired level. Attempt to simulate a cockpit noise level similar to in-flight conditions is possible.

NOTE

Each transmitter must have the internal sidetone levels matched. This is normally a bench adjustment, the sidetone levels should be in the area of 50 milliwatts. Observe vendor procedures and specifications.

6. Should no sidetone be present in pilot or copilot speaker, and the identifier selected is not muted during transmit, select the audio control switch for the transmitter in use for test to SPKR position. If transmitter sidetone is now observed, and is controlled by the copilot SPKR VOL control, it will be necessary to adjust the sidetone level in each individual transmitter. The cockpit speaker sidetone adjustment on the 346B-3 will have no effect.

NOTE

Each transmitter must have the internal sidetone adjustment levels matched. This is normally a bench adjustment, the sidetone levels should be in the area of 8 milliwatts. For the VHF 20A/B, this is about two full turns above zero sidetone output.

- (a) It is necessary to compromise sidetone levels for this configuration. Each transmitter sidetone output must be set high enough to be audible in the on-side headphones with the PHONES VOL set at normal in-flight position, yet low enough to prevent cross-cockpit feedback when the off-side audio selector switch is in SPKR position and the off-side SPKR VOL control is set at normal in-flight position.

7. Should no sidetone be present in copilot speaker but appears in pilot speaker, the identifier selected is not muted and selection of the transmitter in use for test (copilot side, SPKR ON) does not result in copilot speaker sidetone, then the on-side speaker sidetone may be set on the 346B-3 control center to desired level. Observe NOTE above (Aircraft serial numbers 349, 375 and subsequent).
8. Repeat above procedures, set copilot's sidetone levels at 346B-3 as required in Steps 5 and 7 above.

E. PA SELECTION ADJUSTMENT

1. Select PA on Pilot MIC SEL switch. Speak into MIC, adjust Cabin PA level of 346B-3 control center as desired.
  - (a) Operate cabin stereo (if so equipped) and verify that PA removes one stereo channel (normally the right side) and that PA signal appears on this channel.
2. Repeat for copilot PA and 346B-3.

CAUTION

Some aircraft equipped with Seat Belt/No Smoking chimes may find that the Chime Generator unit connection will reduce PA volume from the copilot side. It will be necessary to readjust PA and Chime to reach the desired level.

# SERVICE PUBLICATIONS revision notice

---

SIL NO. 1124-24-005  
Revision No.1

June 20, 1985

SUBJECT: INSPECTION AND TEST OF PRIORITY BUS DIODES

REASON FOR

REVISION: To postfix an addendum to the text following paragraph (13).

Addendum to text:

Those aircraft modified in accordance with Service Bulletin No. 1124-24-008 must change Step 7.(a) to read 0.7 to 1.5 volts to properly reflect the forward voltage drop readings of the new 1N2784 Priority Bus diodes.

SB 1124-24-005  
Page 1 of 1



SUBSIDIARY OF ISRAEL AIRCRAFT INDUSTRIES, LTD  
BEN GURION AIRPORT, ISRAEL

# 1124-WESTWIND

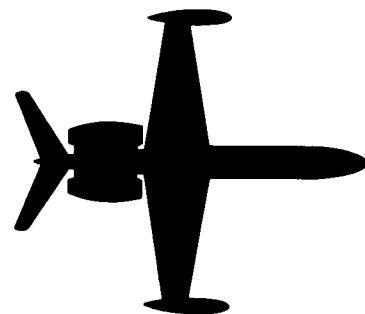

## SERVICE INFORMATION LETTER

---

---

SIL NO. 1124-24-005

December 3, 1984

SUBJECT: INSPECTION AND TEST OF PRIORITY BUSS DIODES

EFFECTIVITY: MODEL 1124, 1124A WESTWIND, S/N 152, 154, 174, 185  
and Subs.

A. REASON

Introduction of a cockpit operational test to establish the condition of the Priority Buss diodes located in the Overhead Circuit Breaker panel, RHS.

B. REFERENCES

1124/1124A Maintenance Manual, Chapter 24-00-00.

C. DESCRIPTION

- (1) External power connected and ON, Battery Master and both Battery switches ON; both inverters in ALT, both Avionics Master Switches OFF.
- (2) Ensure the Distribution Buss Tie Breaker is in normal OPEN (pulled) condition.
- (3) Pull the three #2 (RHS) distribution Buss circuit breakers.
  - (a) Fuel status system ON and operational.
  - (b) RH generator OFF annunciator lamp OUT.
- (4) Reset RHS distribution Buss breakers, pull the three #1 (LHS) distribution Buss breakers.
  - (a) Fuel status system ON and operational.
  - (b) LH generator OFF annunciator lamp OUT.

December 3, 1984



SIL 1124-24-005  
Page 1 of 2

- (5) Reset LHS distribution Buss breakers.
- (6) To determine precise diode condition, remove aircraft power, lower the forward overhead breaker panel, reestablish aircraft power.
- (7) Connect a digital volt meter, negative lead, to cathode (banded end) of priority Buss diodes, or to Buss side of fuel status circuit breaker.
  - (a) Measure to anode and each diode, voltage should be between 0.2 and 0.5 volt DC.
- (8) Remove aircraft power.

NOTE

Failure of tests in paragraphs 3, 4, or 7 above indicate a defective diode, replacement will be necessary.

- (9) Failure of Para. 3 (a) or 4 (b) above will be a defective #1 diode, LHS distribution to priority Buss.
- (10) Failure of Para. 3 (b) or 4 (a) above will be a defective #2 diode, RHS distribution to priority Buss.
- (11) Failure of Para. 7 above; replace diode measuring above or below stated voltage drop limits.
- (12) Retest system if diode replacement is necessary.
- (13) Reassemble aircraft and return to service.

# 1124-WESTWIND

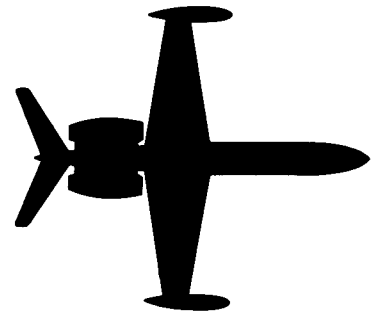

## SERVICE INFORMATION LETTER

---

---

SIL NO. 1124-24-006

December 11, 1984

SUBJECT: ALTERNATE PART FOR ENGINE PYLON FIREWALL BULKHEAD  
CONNECTORS J313 and J314.

EFFECTIVITY: MODEL 1124, serial number 152, 154, 174, 181, 185  
through 300.

A. REASON

To announce the availability of an alternate bulkhead connector P/N MS3450KT28-21S.

B. DESCRIPTION

Intermittent operations have been reported from the field involving powerplant systems. Troubleshooting of these systems revealed a defective J313 and J314 bulkhead connector. Investigations traced the problem to a cracked ceramic insert in each of the connectors.

Cracked connector inserts may not be visible, as the failure normally occurs at the point the insert attaches to the connector shell. This causes the connector pin latches to loosen, which in turn allows the pin to float, eventually wearing the connector pin.

It is this wear, or loss of tension, that causes the problem, as the plating is eventually removed. Cleaning the connector with contact cleaner only delays replacement; in addition some contact cleaners will contaminate the plug insert. This causes additional problems.

To determine if the plug insert is broken; use a thin jaw needle nose pliers, insert into any two pin holes diametrically opposed near plug shell.



SUBSIDIARY OF ISRAEL AIRCRAFT INDUSTRIES, LTD.  
BEN GURION AIRPORT, ISRAEL

SIL 1124-24-006  
Page 1 of 2

Apply a twisting motion, at the same time pulling on the insert. If the plug insert is cracked, it will separate from the shell.

If separation occurs, you must replace the connector, as you will be unable in most cases to push the insert back in place.

If operators experience similar problems with powerplant systems, it is recommended that maintenance personnel investigate connectors J313 and J314.

The replacement part, MS3450KT28-21S, does not incorporate a ceramic insert and is not susceptible to cracking.

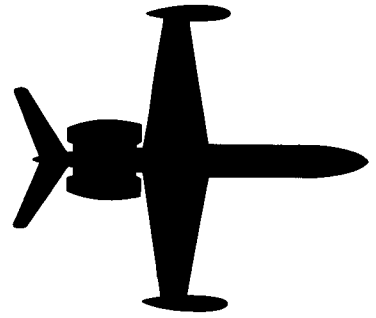

## SERVICE INFORMATION LETTER

---

---

SIL NO. 1124-24-019B

November 14, 1986

(This Service Information Letter dated November 14, 1986 supersedes Service Information Letter No. 1124-24-019A dated May 9, 1986, Service Information Letter No. 1124-24-019 dated February 20, 1985, Revision No. 1 dated June 20, 1985 and Revision No. 2 dated November 15, 1985 in their entirety.)

SUBJECT: DISTRIBUTION BUS CIRCUIT BREAKER INSPECTION

EFFECTIVITY: MODEL 1124/1124A WESTWINDS, all serial numbers

A. REASON

To provide a positive means of inspecting the Aft Contactor Box and Overhead Panel distribution bus circuit breakers.

B. REFERENCES

1124 wiring Diagram Manual, Chapter 24

C. PUBLICATIONS AFFECTED

1124 Maintenance Manual, Chapter 24

D. INSTRUCTIONS

PART A - (TOOLING)

- (1) Construct a load bank using 3 ea. 0.14 Ohm, 1Kw resistors (Ohmite P/N 2303A) connected in series. Reference Figure 1 during construction and for wire connection/identification.
  - (a) Prepare two jumper wires from #8 AWG wire (MIL-W-22729), length not to exceed six inches.



SERVICE INFORMATION LETTER NO. 1124-24-019B

Attach terminal lugs (AMP P/N 322047) at each end of both jumpers. Secure jumper wires as illustrated using AN8-6A bolts, AN960-8 washers and AN340-8 nuts.

- (b) Prepare 3 ea. 8-foot leads of #8 AWG wire (MIL-W-22729) with terminal lugs (AMP P/N 322047) at one end only. Label the three leads for identification during the circuit breaker test procedures. One lead label "COMMON," one lead "100 AMP" and one lead "70 AMP."
- (c) Attach the leads to the load bank as illustrated by their respective markings. The lead labeled "70 AMP" will be attached to the sliding tap approximately 2 inches from the end of the last resistor. Attaching hardware will be the same as noted in step (1)(a).
- (d) Crimp terminal lug (AMP P/N 322047) to free end of lead labeled "COMMON." On the free end of the other two leads, slide a rubber boot (AMP P/N 29569-2) on each lead with the wide end of the boot toward the free end. Crimp a terminal lug (AMP P/N 322047) on the end of each of these leads.

NOTE: The rubber boot is to be used to cover the terminal lug not being used during the circuit breaker inspection procedures.

CAUTION: All connections MUST BE tight and secure to prevent arcing.

- (e) If desirable, the load bank may be enclosed in a metal box. Recommended dimensions are: 22 inches long x 16 inches wide x 8 inches high. This will allow adequate clearance of box and components. Ventilation holes will be needed in the sides and top for proper cooling.

NOTE: Load bank testing prior to aircraft use can be accomplished by connecting the individual load sections (one at a time) to a ground power cart and observing the ammeter on the cart for proper current drain. Do not exceed 90 seconds with power ON.

SERVICE INFORMATION LETTER NO. 1124-24-019B

- (2) Reference PART B of this SIL and Chapter 24-50-00, Temporary Revision 24-1 (page 602) of the 1124 Maintenance Manual for circuit breaker inspection procedures.

INSTRUCTIONS

PART B - (INSPECTION PROCEDURE)

- (1) Lower the forward Overhead Circuit Breaker Panel and gain access to both aft DC Contactor Boxes.
- (2) BATTERY MASTER, INVERTER AND AVIONICS MASTER switches OFF.
- (3) EXTERNAL POWER switch OFF.
- (4) Connect external power unit. All aircraft systems OFF.
- (5) Remove cover from LHS Contactor Box. Disconnect wires 133-10, 124-10 and 135-10 from 50 Amp circuit breakers CB1-1, CB1-2 and CB1-3 respectively.

CAUTION

The following steps will cause the load to become very hot. Use caution in handling and do not permit load resistor assembly to come into contact with interior, system components or personnel to prevent thermal or electrical damage or injury.

- (6) Bolt common end of load bank to a clean airframe ground at overhead structure.
- (7) Connect 100 amp load bank to the open terminal in CB1-1 with a screw to prevent arcing.
- (8) Apply external power. Aft contactor box LHS CB1-1 must trip between 20 and 65 seconds.
  - (a) When breaker trips, the LHS Distribution Bus Feeder Open annunciator must illuminate.
- (9) Remove external power when 65 seconds have elapsed.
  - (a) If CB1-1 has not tripped, or has tripped without illuminating Annunciator, replace breaker P/N 6752-13-50.
  - (b) If CB1-1 has tripped properly, reset it.

SERVICE INFORMATION LETTER NO. 1124-24-019B

NOTE

Load resistance will change with heat.  
Permit load to cool, then proceed.

- (10) Repeat steps (7), (8) and (9) above using CB1-2 and CB1-3.
- (11) Remove 100 amp load. Reconnect wires 133-10, 134-10 and 135-10 to respective circuit breakers.
- (12) Repeat steps (5) through (11) above for RHS using:
  - (a) wire 61-10 for CB2-1;
  - (b) wire 60-10 for CB2-2; and
  - (c) wire 59-10 for CB2-3.
- (13) Push in Distribution Bus Tie circuit breaker.
- (14) Remove wires 1P1A10, 1P2A10 and 1P3A10 from their respective LH Distribution Bus circuit breakers.
- (15) Connect the 70 amp load to each LHS Distribution Bus (35 amp) breaker with a screw, one at a time, observing CAUTION and NOTE above:
  - (a) Apply external power; the OHP breaker must trip between 4 and 35 seconds.
  - (b) Remove external power after 35 seconds.
    - 1 If breaker has not tripped, replace with P/N MS14105-35.
    - 2 If breaker has tripped properly, reset it.
- (16) Pull out the Distribution Bus Tie circuit breaker. Connect the three wires removed in Step (14) above to the respective circuit breaker.
- (17) Repeat Steps (13) through (16) above for RHS Distribution Bus circuit breakers using wires 2P1A10, 2P2A10 and 2P3A10, respectively.
- (18) Remove load resistor grounds and reassemble aircraft.

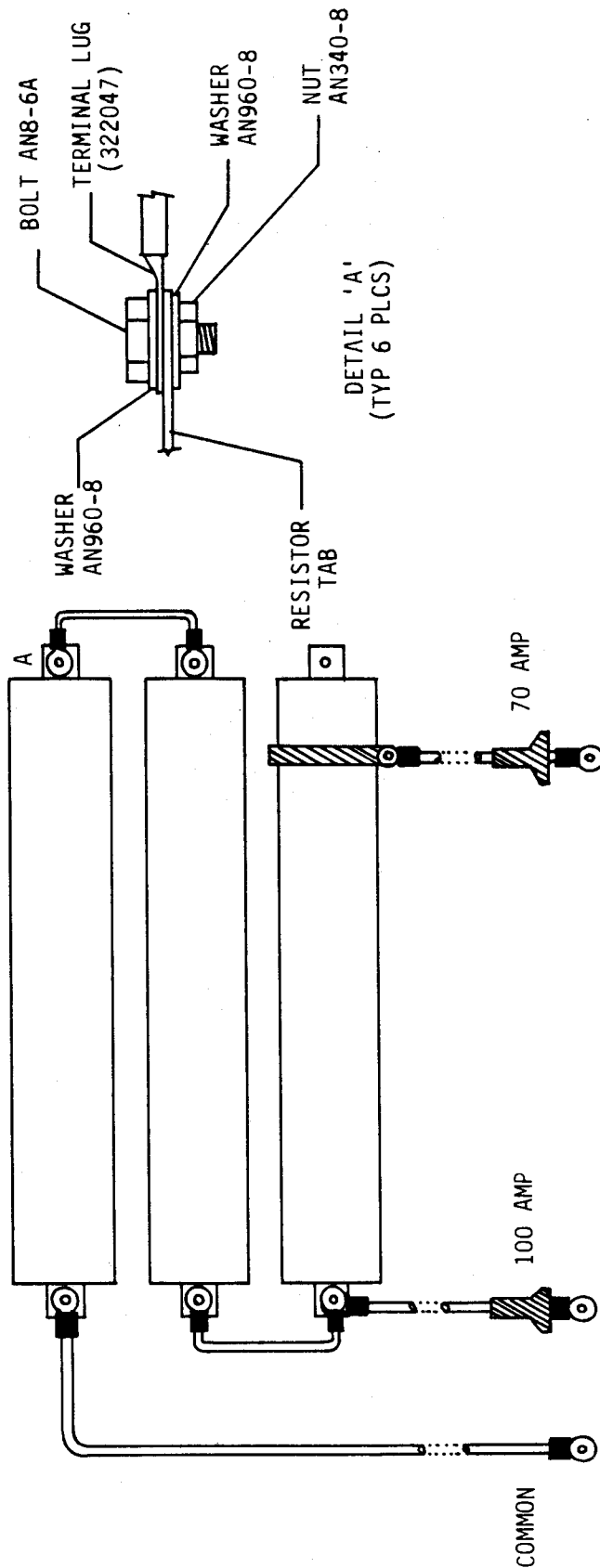
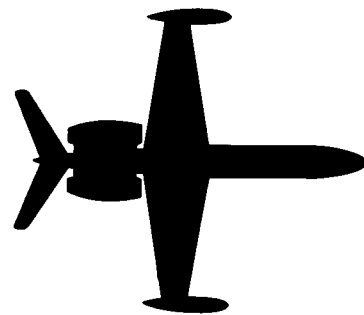

FIGURE 1.

1. LEADS TO BE 8' LENGTH OF #8AWG WIRE MIL-M-22729 (3 EA)
2. RESISTORS (P/N 2303A, OHMITE) 18" LONG X 3" DIAMETER, TAPABLE (3 EA)
3. PROTECTIVE BOOTS ON 100 AMP AND 70 AMP LEADS (AMP P/N 29569-2) (2 EA)
4. ALL TERMINAL LUGS AMP P/N 322047 (9 EA)
5. BOLTS AN8-6A (6 EA)
6. WASHERS AN960-8 (12 EA)
7. NUTS AN340-8 (6 EA)
8. JUMPERS ARE 6" MAXIMUM (2 EA)

# 24-WESTWIND



## SERVICE INFORMATION LETTER

---

---

SIL NO. 1124-24-023

February 25, 1985

SUBJECT: MINIMIZING PRECIPITATION STATIC INTERFERENCE THROUGH  
PROPER AIRCRAFT BONDING.

EFFECTIVITY: MODEL 1124/1124A WESTWINDS, all serial numbers.

A. REASON

To ensure that all flight controls, fiberglass or composite materials, antennas, and inspection panels are bonded to eliminate airframe generated P-Static.

B. REFERENCES

1124/1124A Maintenance Manual  
Chapters: 23-60-00  
24-00-00  
30-10-00  
53-50-00

SB WW-2495A  
SB 1124-23-016  
SIL 1124-23-016

C. PUBLICATIONS AFFECTED

1124/1124A Maintenance Manual.  
Chapters: 23  
24  
30  
55



INTERNATIONAL INC.  
ISRAEL AIRCRAFT INDUSTRIES INTERNATIONAL INC.

SUBSIDIARY OF ISRAEL AIRCRAFT INDUSTRIES, LTD.  
BEN GURION AIRPORT, ISRAEL

SIL 1124-24-023  
Page 1 of 6

D. DESCRIPTION

Aircraft experiencing P-Static interference may perform the following procedures, in part, as necessary as components are removed and replaced. It is recommended that these procedures be followed when aircraft is repainted or any structural repairs are performed. Should aircraft be repainted do not permit stripping compound or water to penetrate under any airframe attachments as this will result in corrosion and poor bonding.

E. INSTRUCTIONS

1. Access panels.

- (a) When an external access panel is removed for inspection or maintenance, clean and polish both mating surfaces and the outer counter-sink screw hole. Iridite (P/N 14-2) the polished areas per vendor instructions.

NOTE

Iridite 14-2 is a corrosion inhibitor and leaves a conductive film after drying. A thin coat provides the best conductivity, as indicated by a yellow tint to applied areas. Brown tinting will indicate the coating is too thick, with resultant poor conductivity.

2. Antennas

- (a) Polish mating surfaces of antennas and airframe and apply Iridite. Remove any corrosion evident.
  - (1) Where sealant or body filler is found under antenna mating surfaces, clean residue. When antenna is remounted, seal outer edges with PR-1422, fair into joint, and repaint as necessary.

- (2) DO NOT PAINT any antennas, as this will create another insulating area over antenna housing and reduce antenna efficiency as well as increasing probability of P-Static generation.
  - (3) Where possible, clean out counterbored antenna mounting screw holes until metal surface is exposed, and install internal tooth star washer (MS35333) of proper size under screw heads prior to installation. Fill counterbore with PR-1422 sealant after assembly.
- (b) Where antenna uses metallized gasket for airframe bond, ensure gasket is not deformed or corroded prior to reassembly. If in doubt, replace gasket.
  - (c) Upon reassembly, ensure proper seal to prevent entry of any contaminants and cabin pressure leaks, where applicable.
3. Deicer boots. (Reference Maintenance Manual, Chapter 30-10-00)
- (a) Inspect both trailing edges of all deicer boots for proper bonding to airframe.
    - (1) There should be a layer of A-56-B conductive cement overlapping the boot and surface color coat about 1/2 inch each, with bare metal exposed between boot and paint approximately 1/4 inch wide that will become the bond for the conductive cement. Application of the boot over the color coat will result in no bond, even with the A-56-B cement applied.
    - (2) Application of deicer boot to metal surfaces should be over bare metal, and conductive cement used.
    - (3) Gently scrape away a small area behind each boot trailing edge, and ensure no color coat or primer exists under conductive cement.
  - (b) Check boot conductivity and bonding with a standard ohmmeter. Ensure a good ground with the (-) lead, and trace along boot surface with flat edge of probe. Resistance value will vary, however no sudden high resistance or opens should be noted. Do not touch meter leads.

- (1) Use of Stainless Steel probes recommended.
  - (2) Do not use probe tip on boot surface, or a puncture will occur.
  - (c) If boot surface is dull and appears slightly brown, the boot is suspect. Application of "Age Master" to entire boot will partially restore boot conductivity.
  - (d) If conductive adhesive cap strip is cracked, or "crazed," it is subject to removal and replacement due to poor bonding.
4. Airframe. (Reference Maintenance Manual, Chapter 24-00-00).
- (a) Perform bonding tests to Aircraft Battery ground attach point. Repair broken or frayed bond strips. Polish attach points and apply Iridite 14-2 prior to reassembly of suspect areas.
  - (b) Satisfactory inspection of airframe P-Static rejection may only be accomplished by a P-Static skin map. Most major Service Centers have this capability, and the test will show Airframe and Fiberglass components improperly bonded or treated.
    - (1) Metal skin surfaces reflecting a high discharge resistance are probably filled with body filler.
      - (a) Remove filler if desired, reprime and paint affected areas.
      - (b) Should it be desired to retain body filler, remove primer and color coat from affected areas until surrounding bare metal is exposed. Apply a Type 1, high conductivity, Anti-Static coating to overlap body filler and exposed metal, re-paint with color coat as required.
5. Fiberglass or Composite Material. (Reference Maintenance Manual Chapter 53-50-00).
- (a) These areas must be completely covered with Type 1, high conductivity, Anti-Static coating prior to color coat.



- (1) Wing tank tail cones, wing to tip tank fairings, flap hinge fairings, MLG fairings, Dorsal fin, Inverter and Ram Air inlets.
  - (b) These areas must be completely covered with Type 2, low conductivity, Anti-Static coating prior to color coat:
    - (1) Radome, Vertical Stabilizer Tip.
  - (c) All areas must be sanded down and a new layer of Anti-Static coating applied prior to repaint. Should repaint occur without this step an additional insulating layer has been formed and the probability of P-Static generation will increase.
  - (d) When applying Anti-Static coating, it is recommended that the coating overlap any sealant or body filler and be allowed to bond to bare metal. In addition, it is highly recommended that all composite area mounting screws be backed out enough to permit Anti-Static coating to adhere to area under screw heads. The screws may then be secured when coating is dry.
  - (e) A quick test to determine if Anti-Static coating exists is to use your standard VOM, (-) lead to ground, and penetrate color coat at suspect areas at several points using a 5° angle from the surface. You should experience a high resistance from any point penetrated. Resistance value will vary, no resistance will indicate no conductive coating, or an excess of color coat.
6. Radome, tip tank tail cones, and Vertical Stabilizer tip contain diverter strips. Reference SIL 1124-23-016 to test and inspect diverter strips, and ensure proper mounting and bonding.
- (a) The radome anti-erosion cap should be of the mylar thermoform type, and it must bond directly to the Anti-Static coating. Under no circumstances should this cap be installed directly over the color coat.
  - (b) It is advisable to apply another coating of Anti-Static paint over the mylar cap prior to applying color coat to radome.

- (c) Should replacement of diverter strips be necessary it is recommended they be installed over Anti-Static coating with conductive cement, and another layer of Anti-Static coating be applied over the diverter strip.
7. Flight Controls and Static Wicks, Reference SB 1124-23-016 and SIL 1124-23-016 for inspection and test procedures.
- (1) If diverter strip replacement is not desired, ensure Anti-Static coating is applied over diverter strip.
8. Tail Cone.

Ensure bond strap is present, and quick disconnects are connected. Polish and Iridite inner cone surface and airframe around fastener attachment areas.

# 24-WESTWIND

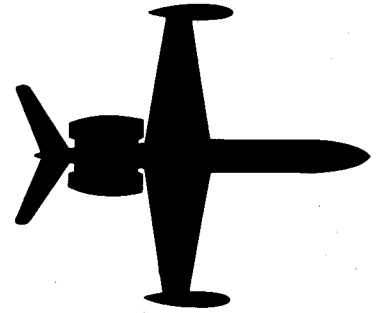

## SERVICE INFORMATION LETTER

---

SIL NO. 1124-24-037

March 21, 1985

SUBJECT: STORAGE OF NICKEL CADMIUM AIRCRAFT BATTERIES

EFFECTIVITY: MODEL 1124/1124A WESTWINDS, all serial numbers.

A. REASON

To remind aircraft operators to adhere to aircraft battery manufacturer's requirements prior to short or long term battery storage.

B. REFERENCES

None

C. PUBLICATIONS

None

D. DESCRIPTION

The aircraft nickel cadmium batteries may be stored indefinitely, charged or discharged, provided specific instructions are adhered to and the storage atmosphere is cool, clean, dry and non-corrosive.

The battery manufacturer's instruction manual outlines procedures for short and long term storage.

Reference should be made to the following publications for storage instructions:



SUBSIDIARY OF ISRAEL AIRCRAFT INDUSTRIES, LTD.  
BEN GURION AIRPORT, ISRAEL

SIL 1124-24-037  
Page 1 of 2

SERVICE INFORMATION LETTER NO. 1124-24-037

<u>MANUFACTURER</u>	<u>TITLE</u>	<u>SOURCE</u>
Saft	Operating and Maintenance Manual	Saft America, Inc. ATTN: Field Services 711 Industrial Boulevard Valdosta, Georgia 31601 (912) 247-2331
Tadiran	Instruction Manual	IAII, Inc. ATTN: Technical Services P.O. Box 10086 Wilmington, Delaware 19806 (302) 322-7240

# 1124-WESTWIND

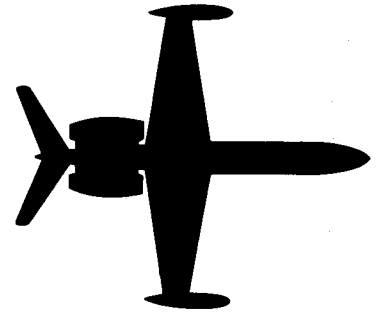

## SERVICE INFORMATION LETTER

---

SIL NO. 1124-24-054

June 5, 1985

SUBJECT: AC STATIC INVERTER IMPROVEMENTS

EFFECTIVITY: MODEL 1124/1124A WESTWIND, all serial numbers.

A. REASON

To prevent severe damage to Avionics and electrical equipment powered by the 1A1000-1D static inverter in the event of inverter overvoltage protection system failure.

The result of the failure mode is an extremely high voltage appearing on both the 115 volt and 26 volt Hz AC electrical bus, which can cause system failures. These system failures will probably occur for a system to fail at an indeterminate later date due to the overvoltage condition.

B. REFERENCES

1124 Service Bulletin WW-24-26.

C. PUBLICATIONS AFFECTED

None

D. DESCRIPTION

1. Ensure your aircraft has been modified to comply with the reference Service Bulletin.
2. Contact the vendor prior to shipping your inverter, for cost and turnaround time. Atlantic Aviation Supply Co. has modified units available for exchange.
3. Units modified under this program will be identified by the letter "M" stamped after the unit serial number.



SUBSIDIARY OF ISRAEL AIRCRAFT INDUSTRIES, LTD.  
BEN GURION AIRPORT, ISRAEL

SIL 1124-24-054  
Page 1 of 3

Avionics Instruments, Inc.  
 943 E. Hazelwood Ave.  
 Rahway, NJ 07065

US Telephone: (201) 388-3500  
 Telex: RCA 247034

Attention: Mr. Ron Risley or Mr. Wally Izzo

4. Below is a listing of all known 1A1000-1D inverters supplied to IAI by the vendor that have not been modified as of 23 April 1985. Check your inverter serial numbers against this list. Should your serial number appear on this list, modification will be required:

0101	1178	1333	1385	C0041018
0102	1187	1334	1386	C0041020
0103	1188	1336	1387	C0042001
0104	1190	1338	1388	C0042003
0105	1191	1339	1389	C0042005
0106	1192	1341	1390	C0042006
0107	1194	1342	1391	C0042007
0108	1195	1343	1393	C0042008
0109	1197	1345	1394	C0042010
0110	1201	1346	1395	C0042011
0142	1206	1351	1396	C0042012
0148	1218	1353	1397	C0042021
0149	1220	1356	1398	C0042023
0165	1224	1360	1400	C0042024
0170	1225	1361	1401	C0042025
0192	1227	1362	1402	C0043003
0193	1235	1363	1406	C0043005
0195	1238	1365	1407	C0043007
0196	1243	1366	1408	C0043014
0197	1305	1367	1409	C0043015
0209	1311	1368	1410	C0043019
0211	1312	1369	1411	C0043022
0212	1313	1370	1413	C0043023
0213	1317	1371	1416	C0043024
0215	1318	1374	1420	C0043025
0216	1320	1375	C0041007	C0043026
0217	1321	1376	C0041008	C0043027
0218	1323	1377	C0041009	C0043029
1111	1324	1378	C0041011	C0043032
1119	1325	1379	C0041012	C0043033
1142	1327	1380	C0041013	C0043037
1167	1328	1381	C0041015	C0151012
1168	1329	1382	C0041016	C0151016
1174	1330		C0041017	C0151022

SERVICE INFORMATION LETTER NO. 1124-24-054

C0151026	C0182003
C0152005	C0182005
C0152006	C0182006
C0152010	C0182008
C0152026	C0182012
C0152027	C0182017
C0152029	C0182018
C0152031	C0182022
C0152032	C0182026
C0152033	C0182027
C0152034	C0182030
C0152035	C0182032
C0152044	C0182034
C0152045	C0182035
C0153001	C0182038
C0153004	C0182039
C0153005	C0182040
C0153006	C0182041
C0153007	C0182042
C0153008	C0182044
C0153010	C0182045
C0153011	C0182046
C0153013	C0182048
C0153016	C0182050
C0153017	
C0153018	
C0181001	
C0181002	
C0181004	
C0181005	
C0181010	
C0181011	
C0181012	
C0181014	
C0181015	
C0181017	
C0181019	
C0181021	
C0181022	
C0181023	
C0181024	
C0181026	
C0181029	
C0181030	
C0181033	
C0181035	
C0181036	
C0181038	
C0181044	

June 5, 1985

SIL 1124-24-054  
Page 3 of 3

C0151026	C0182003
C0152005	C0182005
C0152006	C0182006
C0152010	C0182008
C0152026	C0182012
C0152027	C0182017
C0152029	C0182018
C0152031	C0182022
C0152032	C0182026
C0152033	C0182027
C0152034	C0182030
C0152035	C0182032
C0152044	C0182034
C0152045	C0182035
C0153001	C0182038
C0153004	C0182039
C0153005	C0182040
C0153006	C0182041
C0153007	C0182042
C0153008	C0182044
C0153010	C0182045
C0153011	C0182046
C0153013	C0182048
C0153016	C0182050
C0153017	
C0153018	
C0181001	
C0181002	
C0181004	
C0181005	
C0181010	
C0181011	
C0181012	
C0181014	
C0181015	
C0181017	
C0181019	
C0181021	
C0181022	
C0181023	
C0181024	
C0181026	
C0181029	
C0181030	
C0181033	
C0181035	
C0181036	
C0181038	
C0181044	

June 5, 1985



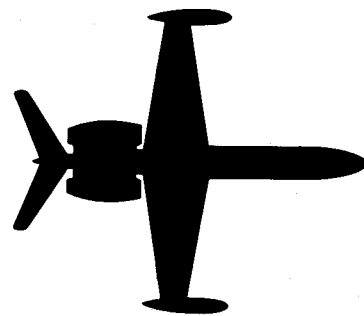

## SERVICE INFORMATION LETTER

---

SERVICE INFORMATION LETTER NO. 1124-24-091

July 17, 1991

**SUBJECT:** ELECTRICAL - LUCAS AEROSPACE (LEAR SIEGLER)  
STARTER GENERATOR BEARING REPLACEMENT

**EFFECTIVITY:** MODEL 1124/1124A WESTWIND equipped with Lucas  
Aerospace (Lear Siegler) Starter-Generator.

**A. REASON**

To extend starter generator service life by replacement of original  
P/N 03-6010-08 armature bearings with new P/N 03-6010-15.

**B. REFERENCE**

Lucas Aerospace Service Bulletin 23065-0XX-24-01, dated 2 October 90, titled  
"Conversion of Model 23065-0XX to 23065-0XX Mod A."

**C. PUBLICATIONS AFFECTED**

None.

**D. DESCRIPTION**

Referenced service bulletin recommends compliance within 500 hours TSN or  
TSO. Modifications should be accomplished to all units by an approved agency  
at time of overhaul or repair, if not previously in compliance.

Modified units should be identified by the letter "A" stamped on the "MOD"  
block of the starter generator plate.

# 1124-WESTWIND

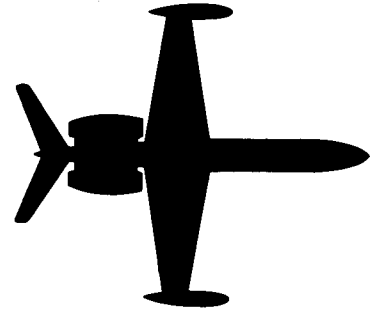

## SERVICE INFORMATION LETTER

---

---

SIL NO. 1124-25-010

December 18, 1984

SUBJECT: PASSENGER SEAT RECLINE CONTROL REMOVAL/INSTALLATION  
IMPROVEMENT.

EFFECTIVITY: MODEL 1124/1124A, all serial numbers.

A. REASON

To provide information on the availability of a new passenger seat recline control cable assembly.

B. REFERENCES

MODEL 1124 IPC, Chapter 25-20-00.

C. PUBLICATIONS AFFECTED

MODEL 1124 IPC, Chapter 25-20-00 will be revised to reflect this information.

D. DESCRIPTION

A new control cable assembly for Westwind passenger seats is now available with a disconnect feature. The new cable assembly replaces the original equipment control cable which was cut and swaged during seat assembly by the manufacturer.

The disconnect feature eliminates the need for special swaging tools and makes cable assy replacement much easier. See Figure 1.

Supply Information is as follows:



SUBSIDIARY OF ISRAEL AIRCRAFT INDUSTRIES, LTD.  
BEN GURION AIRPORT, ISRAEL

SIL 1124-25-010  
Page 1 of 3

SERVICE INFORMATION LETTER NO. 1124-25-010

<u>Seat P/N</u>	<u>Old Control P/N</u>	<u>New Control P/N</u>
G.1.1032 series	Q28-32 (50 in. length)	QT00125-QL00826
G.1.1060 series	Q28-44 (35 in. length)	QT00128-QL00808

NOTE: Torque disconnect 5-10 in-lb only.

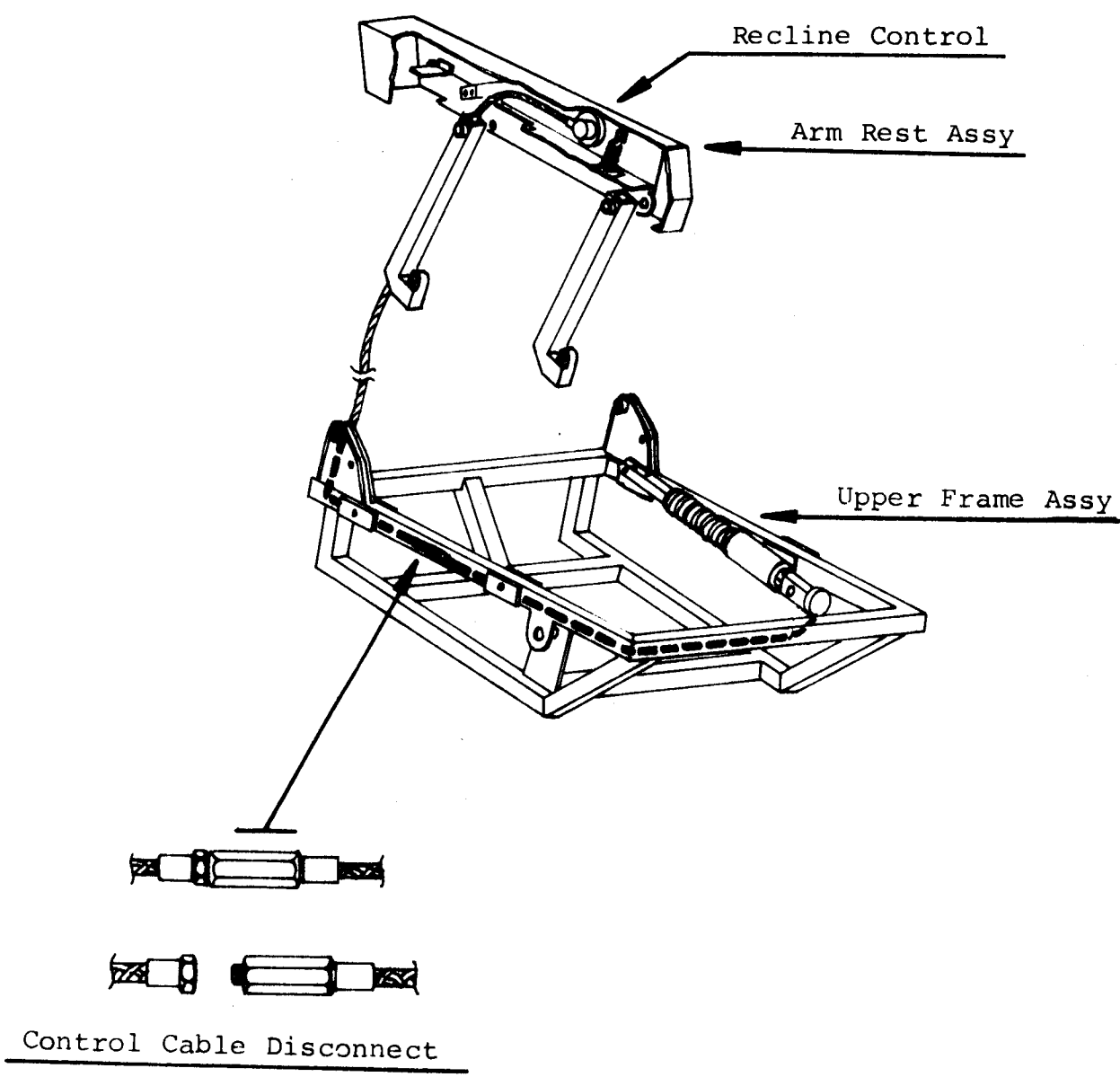
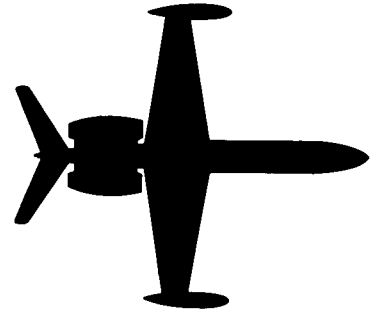

FIGURE 1

# 1124-WESTWIND



## SERVICE INFORMATION LETTER

---

---

SIL NO. 1124-25-027

March 20, 1985

SUBJECT: IMPROVED STEREO SPEAKER CLARITY

EFFECTIVITY: MODEL 1124A aircraft equipped with factory installed stereo system.

A. REASON

Instructions provided here-in outline a suggested method to modify the cabin side-panels that will improve stereo sound.

B. REFERENCES

None

C. PUBLICATIONS AFFECTED

None

D. DESCRIPTION

- (1) Locate stereo speaker installation at stations 144.0, 170.00 and 215.0 (approximate) as shown in Figure 3.
- (2) Remove cabin side-panels.
- (3) Place side-panels face down on clean working surface.
- (4) Side-panel construction is shown in Figure 1.



SUBSIDIARY OF ISRAEL AIRCRAFT INDUSTRIES, LTD.  
BEN GURION AIRPORT, ISRAEL

SIL 1124-25-027  
Page 1 of 4

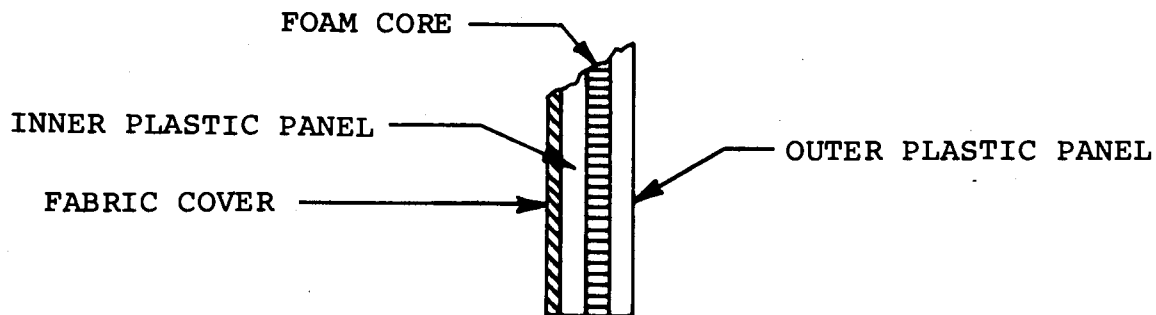

FIGURE 1

- (5) Locate factory drilled speaker grid on side wall panels. (See Figure 3).
- (6) Trace cut-out pattern on speaker grids as shown in Figure 2. Cut and remove sections in outer plastic panel, foam core, and inner plastic panel.

CAUTION

Care must be exercised when cutting and removing sections from inner panel to prevent damage to interior fabrics. Proceed making light cuts until sections of the cut-out can be removed.

- (7) Modify remaining speaker grids including grid for speaker located behind the Divan (if installed).
- (8) Reinstall cabin side-panels and return aircraft to service.

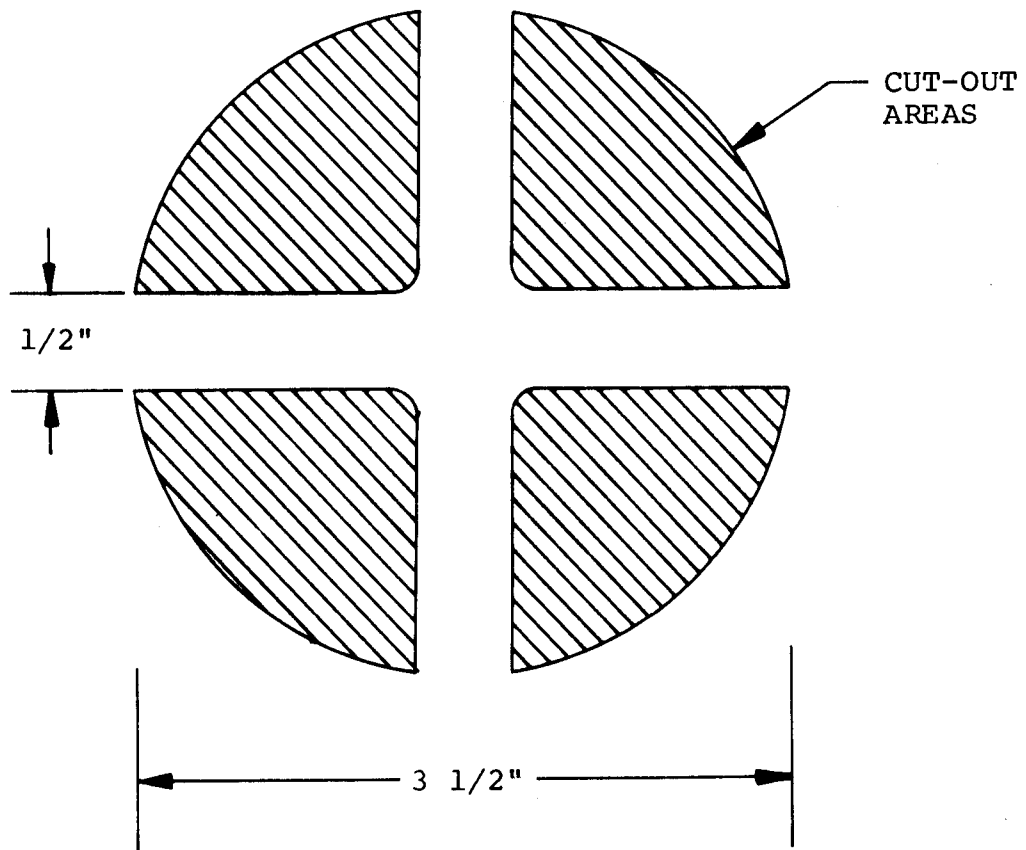

CUT-OUT SPEAKER GRIDS (6 PLACED)

FIGURE 2

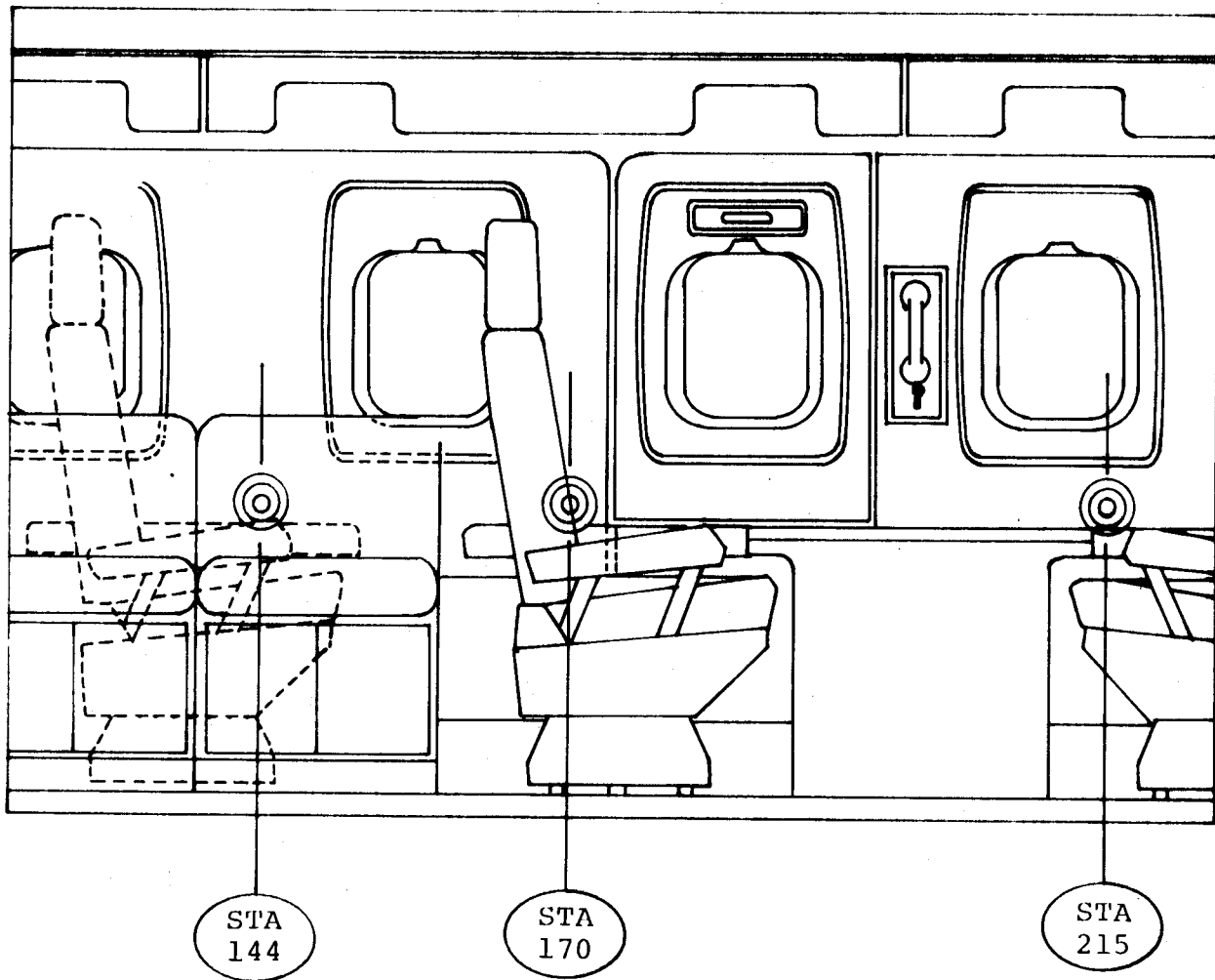
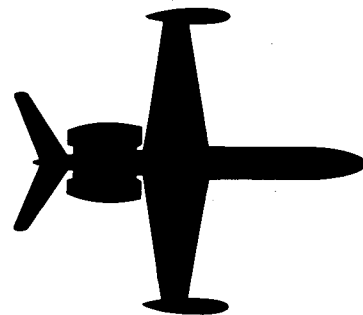

FIGURE 3 (RIGHT HAND SHOWN - LEFT HAND IDENTICAL)



# 1124-WESTWIND



## SERVICE INFORMATION LETTER

---

---

SIL NO. 1124-25-055

June 14, 1985

SUBJECT: SHERWOOD TOILET P/N 2051 TIMER FAILURES

EFFECTIVITY: MODEL 1124 WESTWIND, S/N 187 through 244.

A. REASON

To eliminate the P/N 2051 timer assembly by providing a manual flushing switch.

B. REFERENCES

None

C. PUBLICATIONS AFFECTED

None

D. DESCRIPTION

It is possible to remove the timer assembly and replace it with a momentary action (normally open) pushbutton switch of a minimum 5 amp contact rating.

You must still close the toilet lid prior to flushing.

Switches of many physical dimensions and pushbutton sizes are readily available at any electronic parts wholesalers and are manufactured by all major switch vendors.

Mount your new switch and a "TOILET FLUSH" placard at any convenient location on the toilet assembly base. Remove timer and disconnect the red, white and black wires from the timer terminal block. Connect the new switch (normally open contacts if you use a double throw switch) to the terminal block where the BLACK and WHITE wires were removed.



SUBSIDIARY OF ISRAEL AIRCRAFT INDUSTRIES, LTD.  
BEN GURION AIRPORT, ISRAEL

SIL 1124-25-055  
Page 1 of 1

# 24-WESTWIND

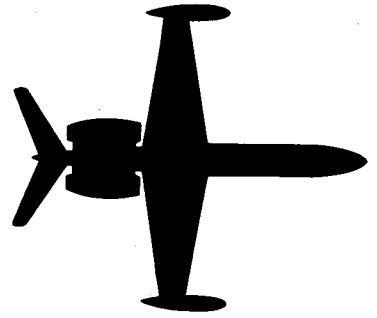

## SERVICE INFORMATION LETTER

---

---

SIL NO. 1124-25-059B

August 18, 1986

This Service Information Letter No. 1124-25-059B dated August 18, 1986 supersedes Service Information Letter No. 1124-25-059A dated December 20, 1985 and Service Information Letter No. 1124-25-059 dated November 8, 1985 in their entirety.

SUBJECT: PORTABLE FIRE EXTINGUISHERS

EFFECTIVITY: MODEL 1124/1124A WESTWINDS, all serial numbers.

A. REASON

To provide information to operators regarding the maintenance and use of cockpit and cabin fire extinguishers.

B. REFERENCES

FAA Advisory Circular No. 20-42C dated March 7, 1984  
Extinguisher manufacturer's instructions (extinguisher label)

C. PUBLICATIONS AFFECTED

None

D. DESCRIPTION

1. General

All model aircraft should be equipped with two portable fire extinguishers, one located in the cockpit and one in the cabin. The extinguishing agent should be either Halon 1211 or Halon 1301. Carbon dioxide, water or dry chemical extinguishers are not recommended. Hand-held fire extinguishers approved by Underwriters Laboratories or by U.S. Coast Guard under Title 46 of the CFR will be accepted by the FAA for use in aircraft. The contained weight of Halon 1211 per extinguisher should be no more than 2.5 pounds. Halon 1301 extinguishers should have a minimum rating of 2B:C, with the contained weight per extinguisher of no more than 4 pounds.



NOTE: The extinguishers referred to above are not U.L. rated for Class A fires (those including normal combustible materials such as wood, cloth, paper, etc.). There is no reason why Class A fires cannot be extinguished utilizing Halon-type extinguishers. However, if they prove ineffective (such as in the case of a smoldering seat cushion, for example), water carried from the lavatory or application of non-alcoholic beverages that may be available will aid in extinguishing the fire .

## 2. Toxicity

Halon 1211 and Halon 1301 are considered low-toxicity extinguishing agents. However, exposure to high concentrations even for short periods of time can produce dizziness, impaired coordination and reduced mental sharpness, hence the maximum agent weight recommendations in 1. above. There are no known lasting effects from exposure to these agents.

When Halon 1211 or 1301 is discharged onto a fire, it decomposes and releases halide ions (the extinguishing agent). In addition, other halogen compounds are formed which are considered toxic. The amount of toxic compounds formed depends on the size of the fire, but these should be considered far less hazardous than those produced by the fire itself.

To summarize, the danger from fire and associated smoke, fumes, oxygen depletion and carbon monoxide generation is much greater than that caused by exposure to Halon 1211/1301 or its decomposition products.

## 3. Placards

If the fire extinguisher is not located where it can be seen, a highly visible placard should be provided.

## 4. Maintenance

- (a) Inspect extinguishers monthly for corrosion, damage or low reading on pressure gauge.
- (b) Weigh extinguishers every six (6) months. Record weight on maintenance tag. Replace or recharge if the weight falls below the limit specified on the extinguisher label.
- (c) Pressure test every twelve (12) years, preferably by the manufacturer.

# **24-WESTWIND**

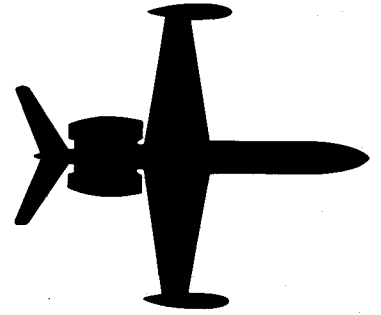

## **SERVICE INFORMATION LETTER**

---

---

SIL NO. 1124-25-059

REVISION-1

July 31, 1989

### TRANSMITTAL SHEET

This sheet transmits Revision 1 to Service Information Letter No. 1124-25-059, dated November 8, 1985, titled "Portable Fire Extinguishers."

#### REASON FOR REVISION:

This service information letter is revised to correct and add information regarding maintenance of portable fire extinguishers.

Paragraph D.4. - Maintenance is revised in its entirety.

This service bulletin is reissued in its entirety. Please remove and discard all pages of previous issues and replace with pages of this issue.

#### LIST OF EFFECTIVE PAGES

<u>Page No.</u>	<u>Date</u>
1	July 31, 1989
2	July 31, 1989
3	July 31, 1989

#### PREVIOUS REVISIONS:

1124-25-059A dated December 20, 1985  
1124-25-059B dated August 18, 1986



November 8, 1985

SUBSIDIARY OF ISRAEL AIRCRAFT INDUSTRIES, LTD.  
BEN GURION AIRPORT, ISRAEL

TRANSMITTAL  
Page 1 of 1

# 24-WESTWIND

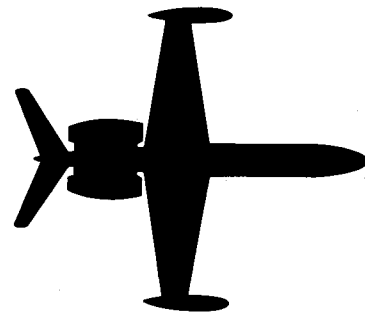

## SERVICE INFORMATION LETTER

---

---

R SIL NO. 1124-25-059

November 8, 1985

SUBJECT: PORTABLE FIRE EXTINGUISHERS

EFFECTIVITY: MODEL 1124/1124A WESTWINDS, all serial numbers.

A. REASONS

To provide information to operators regarding the maintenance and use of cockpit and cabin fire extinguishers.

B. REFERENCES

FAA Advisory Circular No. 20-42C dated March 7, 1984.

Extinguisher manufacturer's recommendations.

Code of Federal Regulations, Chapter 29, Section 1910.157(e).

Code of Federal Regulations, Chapter 49, Section 173.306(c)(5).

C. PUBLICATIONS AFFECTED

None.

D. DESCRIPTION

1. General

All model aircraft should be equipped with two portable fire extinguishers, one located in the cockpit and one in the cabin. The extinguishing agent should be either Halon 1211 or Halon 1301. Carbon dioxide, water or dry chemical extinguishers are not recommended. Hand-held fire extinguishers approved by Underwriters Laboratories or by U.S. Coast Guard under Title 46 of the CFR will be accepted by the FAA for use in aircraft. The contained weight of Halon 1211 per extinguisher should be no more than 2.5 pounds. Halon 1301 extinguishers should have a minimum rating of 2B:C, with the contained weight per extinguisher of no more than 4 pounds.



R November 8, 1985

SUBSIDIARY OF ISRAEL AIRCRAFT INDUSTRIES, LTD.

SIL 1124-25-059

R Revision 1, July 31, 1989

BEN GURION AIRPORT, ISRAEL

Page 1 of 3

NOTE: The extinguishers referred to above are not U.L. rated for Class A fires (those including normal combustible materials such as wood, cloth, paper, etc.). There is no reason why Class A fires cannot be extinguished utilizing Halon-type extinguishers. However, if they prove ineffective (such as in the case of a smoldering seat cushion, for example), water carried from the lavatory or application of non-alcoholic beverages that may be available will aid in extinguishing the fire.

2. Toxicity

Halon 1211 and Halon 1301 are considered low-toxicity extinguishing agents. However, exposure to high concentrations even for short periods of time can produce dizziness, impaired coordination and reduced mental sharpness, hence the maximum agent weight recommendations in 1. above. There are no known lasting effects from exposure to these agents.

When Halon 1211 or 1301 is discharged onto a fire, it decomposes and releases halide ions (the extinguishing agent). In addition, other halogen compounds are formed which are considered toxic. The amount of toxic compounds formed depends on the size of the fire, but these should be considered less hazardous than those produced by the fire itself.

To summarize, the danger from fire and associated smoke, fumes, oxygen depletion and carbon monoxide generation is much greater than that caused by exposure to Halon 1211/1301 or its decomposition products.

3. Placards

If the fire extinguishers is not located where it can be seen, a highly visible placard should be provided.

4. Maintenance

(a) Monthly (or more frequently).

(1) Check pressure gauge. Pressure should be in the green band.

(2) Check that nozzle is not obstructed.

(3) Check that locking mechanism is intact.

(4) Check for physical damage or corrosion.

R  
R  
R  
R  
R

SERVICE INFORMATION LETTER NO. 1124-25-059

- R (b) Yearly.
- R (1) Weigh unit and record weight on maintenance  
R tag.
- R (2) Replace or recharge if the weight falls below  
R the limit specified on the extinguisher label.
- R (c) Every six years.
- R (1) Discharge unit, overhaul valve, and refill per  
R manufacturer's maintenance instructions  
R (preferably by manufacturer).
- R (d) Every twelve years.
- R (1) Perform hydrostatic test on cylinder  
R (preferably by manufacturer).

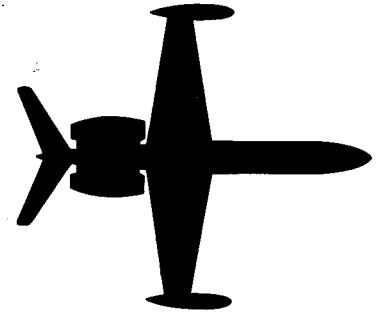

# SERVICE INFORMATION LETTER

SERVICE INFORMATION LETTER NO. 1124-25-096

July 1, 1992

**SUBJECT:** EQUIPMENT/FURNISHINGS - EXTENDED OVER WATER OPERATIONS, SAFETY AND SURVIVAL EQUIPMENT

**EFFECTIVITY:** MODEL 1124/1124A WESTWIND, all serial numbers.

**A. REASON**

To emphasize the importance of preflight preparation for extended over water flights.

**B. REFERENCE**

Civil Air Regulation (CAR) Part 4b.  
Federal Aviation Regulation (FAR) Part 91 and 135.

**C. PUBLICATIONS AFFECTED**

None.

**D. DESCRIPTION**

This Service Information Letter is intended to serve as a reminder to operators that a passenger briefing (FAR 91.519 and 135.117) shall be conducted prior to extended over water flights. Safety equipment shall be readily accessible to the flight crew (CAR 4b.646), and life preservers within easy reach [CAR 4b.646(d)] of each seated occupant. Further requirements may be found in Civil Air Regulations (CAR) Part 4b.



# 1124-WESTWIND

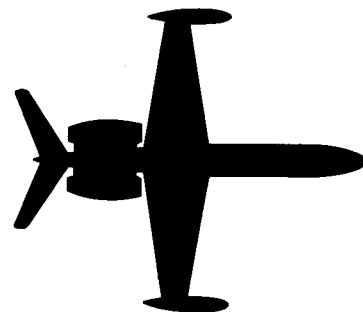

## SERVICE INFORMATION LETTER

---

---

SIL NO. 1124-27-002

November 9, 1984

SUBJECT: FLAP ASSYMMETRY COMPARATOR CONTROL BOX FAILURES AND  
NUISANCE FLAP IMBALANCE WARNINGS

EFFECTIVITY: MODEL 1124/1124A AIRCRAFT, SERIAL NUMBER 152,  
154, 174, 181, 185 through 396.

### A. REASON

To introduce an approved replacement Control Box to:

- (1) Eliminate Control Box failures due to electrical system transient voltages.
- (2) Reduce imbalance warnings caused by Flap Position Transmitter and other system noises.

### NOTE

The information contained in this Service Information Letter will NOT compensate for improperly adjusted or defective Flap Position Transmitters.

### B. REFERENCES

1124 Maintenance Manual, Chapter 27.

### C. PUBLICATIONS AFFECTED

1124/1124A Illustrated Parts Catalog.

November 9, 1984



SUBSIDIARY OF ISRAEL AIRCRAFT INDUSTRIES, LTD.  
BEN GURION AIRPORT, ISRAEL

SIL 1124-27-002  
Page 1 of 3

D. DESCRIPTION

- (1) 1124 aircraft through serial number 282 were equipped with P/N 2813521-501 Control Box and 1124A S/N 239 was equipped with the P/N 2813521-503 configuration. 1124 aircraft in this serial number range may have replaced the Control Box with the -503 version. Both the -501 and -503 were equipped with nut-plates and mounted inside the Flap Contactor Box.
- (2) 1124 and 1124A aircraft from S/N 283 through 312 were equipped with the P/N 2813521-503 Control Box (with nut-plates) and mounted at the Flap Contactor Box.
- (3) 1124 and 1124A aircraft from S/N 313 through 396 were equipped with the P/N 2183521-503 Control Box (with nut-plates) and mounted at the Flap Contactor Box; or with the -505 version (without nut-plates) mounted in the Aft Relay Box.
- (4) All Control Box configurations (-501, -503, -505) above were equipped with circuit board P/N 5710-4992. The -503 and -505 versions used the P/N 5710-4992 circuit board with an additional capacitor installed.
- (5) This Service Information Letter authorizes replacement of the original -501, -503 or -505 Control Box with new P/N 2813521-507. This new 2813521-507 Box contains a new circuit board P/N 5710-4974 or a P/N 5710-4992 which is factory modified to the 5710-4974 configuration.
- (6) Should you experience a problem requiring a replacement Control Box, it is recommended you order and replace the circuit board with the new P/N 5710-4974 utilizing the following procedures:
  - (a) Identify the new circuit board by the P/N etched on the board itself, and/or a red dot painted on the connector shell.
  - (b) Remove Control Box from aircraft.
  - (c) To replace circuit board, first remove safety wire securing connector nut. Remove connector nut and the two screws at the rear of the Control Box.

- (d) Slide front plate and circuit board assembly from Control Box housing.
  - (e) Remove four screws securing circuit board rails; separate defective board from rails.
  - (f) Reassemble, using replacement circuit board in reverse order with existing hardware. Add new safety wire to connector nut.
  - (g) Identify your Control Box as containing the modified circuit board by attaching a new label stating -507 to the right of the existing part number label or stamp.
- (7) Should you wish to replace the entire Control Box assembly, order new P/N 2813521-507. If you order the original -501, -503, or -505 number; you will receive the -507 version.
- (a) Use of the -507 configuration in place of earlier -501 and -503 versions will require mounting the unit, using original screws, and adding AN/MS stop nuts as the -507 version will not have the nut-plates installed.
- (8) Perform normal flap unbalance tests (REF 1124 Maintenance Manual, Chapter 27-50-00) and return aircraft to service.

# SERVICE PUBLICATIONS

# revision notice

---

*Cancelled May 29, 1990*

SIL NO. 1124-27-028  
Revision No.1

June 14, 1985

SUBJECT: FLAP LIMIT SWITCH REPLACEMENT

REASON FOR

REVISION: To change a part number in paragraph 6 and a MIL Spec number in paragraph 9.

6. Apply a coat of red enamel glyptal 1201 (insulating paint) on the switch mounting area.
9. Apply MIL-S-8802 potting compound on all electrical wire connections. Reinstall cover using retained hardware.

SB 1124-27-028  
Page 1 of 1



SUBSIDIARY OF ISRAEL AIRCRAFT INDUSTRIES, LTD  
BEN GURION AIRPORT, ISRAEL

**1124-24-WESTWIND**

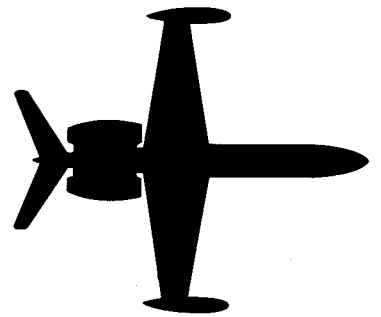

**SERVICE  
INFORMATION LETTER**

---

---

SIL NO. 1124-27-028

REVISION 1

May 29, 1990

SUBJECT: FLAP LIMIT SWITCH REPLACEMENT

**CANCELLATION NOTICE**

This service information letter is hereby canceled. The information contained in this SIL has been incorporated into the 1124 Westwind Maintenance Manual, Chapter 27-50-00.

# 1124-WESTWIND

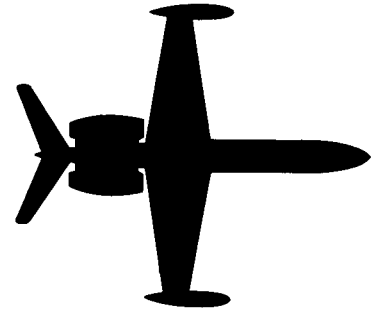

## SERVICE INFORMATION LETTER

---

SIL NO. 1124-27-028

May 16, 1985

SUBJECT: FLAP LIMIT SWITCH REPLACEMENT

*CANCELLED*

EFFECTIVITY: 1124/1124A WESTWINDS, all serial numbers.

A. REASON

Provide instructions for field replacement of flap limit switches.

B. REFERENCES

None

C. PUBLICATIONS AFFECTED

1124 Illustrated Parts Catalog.

1124 Maintenance Manual, Chapter 27-50-00.

D. DESCRIPTION

1. Remove flap limit switch assemblies as per 1124 Maintenance Manual Chapter 27-50-00.
2. Remove cover from limit switch assembly and retain hardware for reinstallation.

NOTE

The left assembly consists of six actuating switches. The right assembly consists of two actuating switches.



SUBSIDIARY OF ISRAEL AIRCRAFT INDUSTRIES, LTD.  
BEN GURION AIRPORT, ISRAEL

SIL 1124-27-028A  
Page 1 of 2

SERVICE INFORMATION LETTER NO. 1124-27-028

3. Remove potting compound from all switches.
4. Remove existing switches from assembly. Retain hardware for reinstallation.
5. Clean switch mounting area using enamel remover or equivalent.
6. Apply a coat of red enamel glyptal 1201 (insulating paint) on the switch mounting area.
7. Install new switches and switch actuators in all positions and solder electrical connections.
8. Check for proper switch actuation by extending and retracting the slider while checking for continuity with an ohmmeter on each individual switch.
9. Apply MIL-S-8802 potting compound on all electrical wire connections. Reinstall cover using retained hardware.
10. Reinstall flap limit switch assemblies as per 1124 Maintenance Manual Chapter 27-50-00.

# **24-WESTWIND**

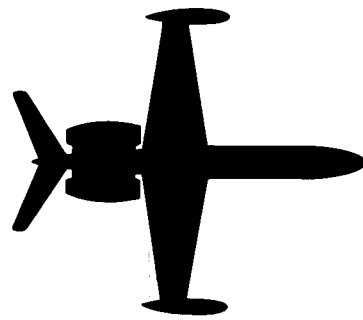

## **SERVICE INFORMATION LETTER**

---

---

SIL NO. 1124-27-030

REVISION 1

May 29, 1990

**SUBJECT: MEASUREMENT LIMITS OF AILERON TRIM AND SERVO TAB  
FREEPLAY**

### **CANCELLATION NOTICE**

This service information letter is hereby canceled. The information contained in this service information letter has been incorporated into the 1124 Westwind Maintenance Manual, Chapter 27-10-00.



# 1124-WESTWIND

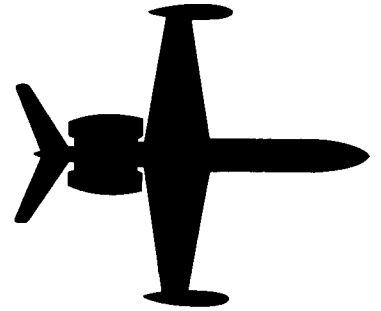

## SERVICE INFORMATION LETTER

---

---

SIL NO. 1124-27-030

March 20, 1985

*CANCELLED*

SUBJECT: MEASUREMENT LIMITS OF AILERON TRIM AND SERVO TAB  
FREEPLAY

EFFECTIVITY: 1124/1124A WESTWINDS, all serial numbers.

A. REASON

To establish aileron trim and servo tab freeplay limits and provide instructions for measuring freeplay.

B. REFERENCES

None

C. PUBLICATIONS AFFECTED

Instructions and limits outlined in this Service Information Letter will be included in the next scheduled revision to the 1124/1124A Maintenance Manual.

D. DESCRIPTION

NOTE

The location for freeplay measurements are identical for both the trim tab and servo tab (with exception of the freeplay limit differences).

- (1) Place dial indicator measuring point at trailing edge of tab 5 inches from outboard edge. Zero indicator.



SUBSIDIARY OF ISRAEL AIRCRAFT INDUSTRIES, LTD.  
BEN GURION AIRPORT, ISRAEL

SIL 1124-27-030  
Page 1 of 3

SERVICE INFORMATION LETTER NO. 1124-27-030

- (2) Apply up/down force of 1 pound to tab trailing edge adjacent to the dial indicator measurement point.
- (3) Note tab freeplay. Limits should not exceed:  
Aileron Trim Tab (LH) = 0.085 inch.  
Aileron Servo Tab (RH) = 0.043 inch.
- (4) If freeplay exceeds stated limits, check all rod-ends and bolts installed for wear. Replace worn components as required.

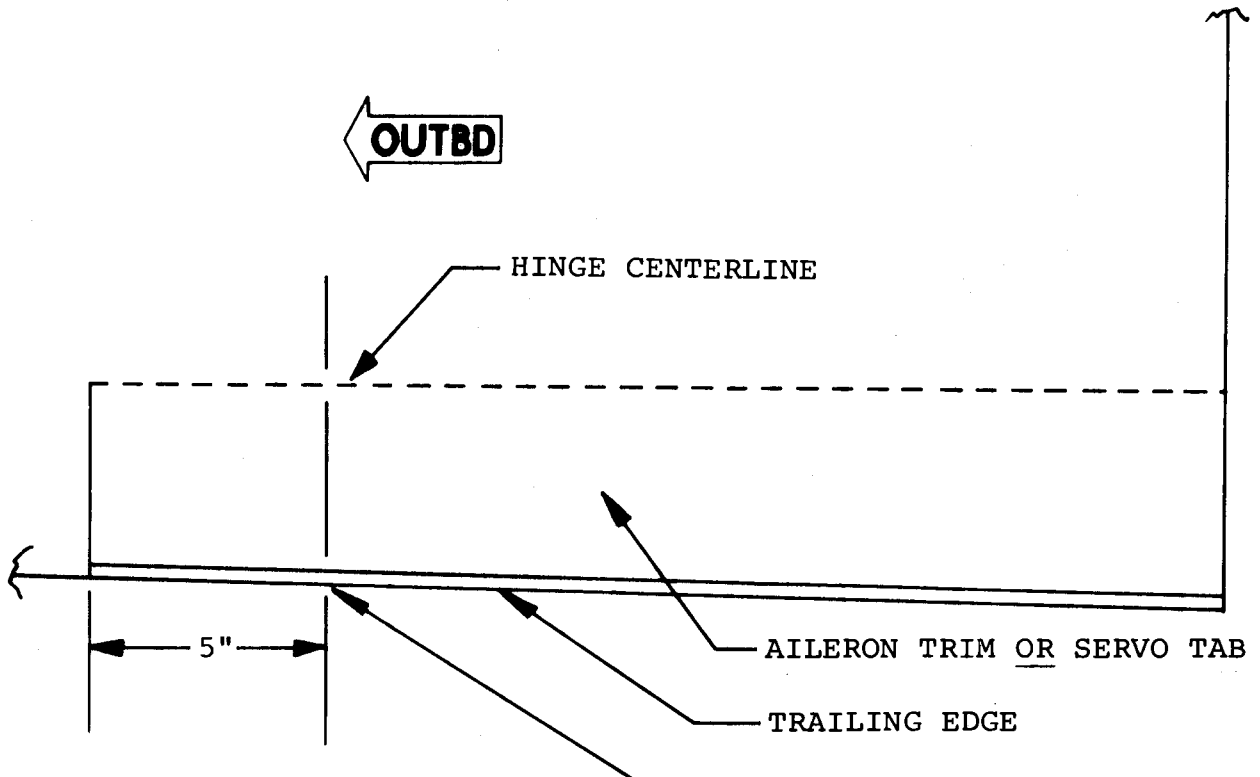

MEASURE TAB FREEPLAY AT THIS POINT  
APPLY 1 POUND FORCE ADJACENT  
TO DIAL INDICATOR MEASUREMENT  
POINT.

# 1124-WESTWIND

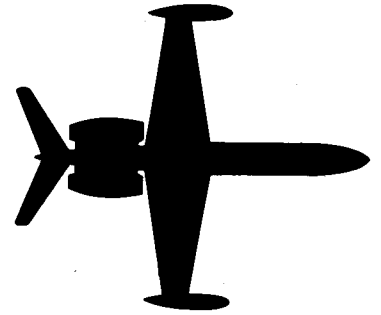

## SERVICE INFORMATION LETTER

---

---

SIL NO. 1124-27-057

September 16, 1985

SUBJECT: RUDDER AND TABS - SYNCHRONIZATION OF DUAL ACTUATORS

EFFECTIVITY: MODEL 1124/1124A, all serial numbers

A. REASON

To provide operators with advanced information on travel tolerances for checking synchronization of dual rudder trim tab actuators that will appear in a future revision of the 1124 Maintenance Manual.

B. REFERENCES

Model 1124/1124A Maintenance Manual, Chapter 27  
Model 1124/1124A Wiring Diagram Manual, Chapter 27

C. PUBLICATIONS AFFECTED

Model 1124/1124A Maintenance Manual, Chapter 27, will be revised to reflect synchronization checks of the rudder trim tab actuators.

D. DESCRIPTION

1. Travel tolerance of dual rudder trim tab actuators have been changed to better coordinate the movement of the two actuators and prevent tab warpage.
2. When changing only one actuator, it may be beneficial to check the remaining actuator for compliance with the new requirements and insure proper synchronization.
3. Refer to Model 1124/1124A Maintenance Manual, Chapter 27-20-00 for actuator removal and reinstallation.
4. Refer to Model 1124/1124A Wiring Diagram Manual for electrical hook-up.

SIL 1124-27-057  
Page 1 of 2



SUBSIDIARY OF ISRAEL AIRCRAFT INDUSTRIES, LTD.  
BEN GURION AIRPORT, ISRAEL

SERVICE INFORMATION LETTER NO. 1124-27-057

5. Mount actuator in a fixture capable of applying 150 lbs of load on the "extend and retract" position of the actuator.
6. Apply 28 Vdc at 1.5A and operate actuator to extend and retract and check tolerances as follows:
  - Travel Distance: .425 to .430 inch
  - Travel Speed: 27 to 29 seconds, one way
7. Actuators may also be returned to Atlantic Aviation for check.
8. Actuators found out-of-adjustment should be returned to Atlantic Aviation for adjustment.

# 1124-WESTWIND

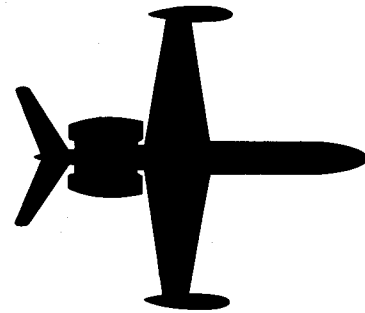

## SERVICE INFORMATION LETTER

---

SIL NO. 1124-27-063

February 7, 1986

SUBJECT: TO ANNOUNCE THE AVAILABILITY OF A NEW EMI FILTER

EFFECTIVITY: MODEL 1124/1124A WESTWINDS, all serial numbers.

A. REASON

The filter presently installed on the horizontal trim actuator is prone to shorts/open and may be a cause of primary motor failure.

B. REFERENCE

None.

C. PUBLICATIONS AFFECTED

None.

D. DESCRIPTION

An improved horizontal trim EMI filter has been developed to improve actuator performance. Overhaul agencies have been informed of improved filters for incorporation in new overhauls.



SUBSIDIARY OF ISRAEL AIRCRAFT INDUSTRIES, LTD.  
BEN GURION AIRPORT, ISRAEL

SIL 1124-27-063  
Page 1 of 1

# 1124-WESTWIND

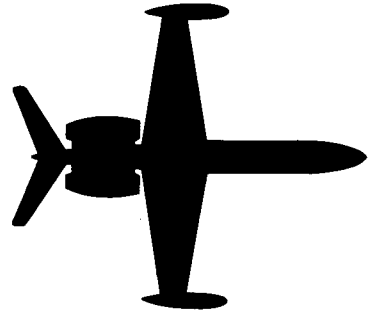

## SERVICE INFORMATION LETTER

SIL NO. 1124-27-064

February 7, 1986

SUBJECT: HORIZONTAL TRIM ACTUATOR - AXIAL PLAY

EFFECTIVITY: MODEL 1124/1124A WESTWINDS, all serial numbers.

A. REASON

To provide operators with advanced maintenance manual information on axial play tolerances for the horizontal trim actuator rods.

B. REFERENCES

None.

C. PUBLICATIONS AFFECTED

1124/1124A Maintenance Manual, Chapter 27-40-00 will be revised to reflect added tolerance information.

D. DESCRIPTION

When performing the "Adjustment/Test" portion of maintenance manual instructions, check the axial free play of rods to .000 to .009 inch excluding rod-end fitting.

SIL 1124-27-064  
Page 1 of 1



SUBSIDIARY OF ISRAEL AIRCRAFT INDUSTRIES, LTD.  
BEN GURION AIRPORT, ISRAEL

# **24-WESTWIND**

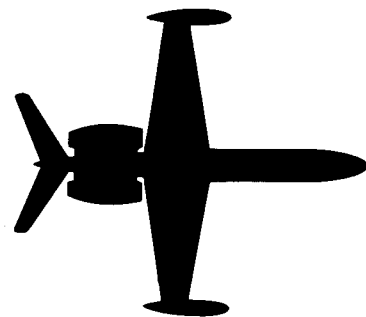

## **SERVICE INFORMATION LETTER**

---

---

**SERVICE INFORMATION LETTER NO. 1124-27-107**

**December 14, 1994**

**SUBJECT: FLIGHT CONTROLS - RIGHT INBOARD FLAP FLEXIBLE  
DRIVE SHAFT ROUTING**

**EFFECTIVITY: MODEL 1124/1124A WESTWIND, all serial numbers.**

**A. REASON**

To insure adequate inspection for proper flap inboard flexible drive shaft routing during maintenance of flexible drive shafts or routine inspections.

**B. REFERENCE**

1124/1124A Westwind Maintenance Manual, 5-20-05 and 27-50-00.

**C. PUBLICATIONS AFFECTED**

None.

**D. DESCRIPTION**

One instance of undetected interference between the right inboard flap flexible drive shaft assembly and the aileron autopilot servo capstan arm has been reported. Evidence of chafing contact between the forward edge of the aileron autopilot servo capstan arm and the flexible drive shaft housing was noted.

During routine maintenance of the flap flexible drive shaft installation or general visual inspection of the fuselage station 316 area, proper flexible drive shaft routing must be verified. Improper flexible drive shaft routing and resultant interference with adjacent equipment is possible by inverting flexible drive shaft mounting clamps during installation.

A thorough inspection of the area is advised during flap flexible drive shaft removal/installation, and during routine inspections of all equipment mounted on or near fuselage station 316. Reference 1124/1124A Westwind Maintenance Manual, 27-50-00, Servicing and Removal/Installation, and 5-20-05, Maintenance Practices.



# 1124-WESTWIND

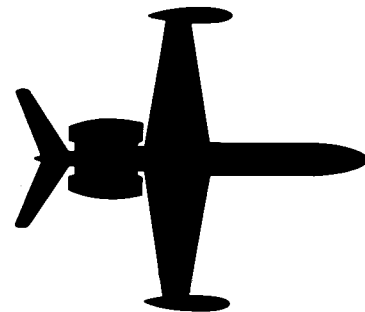

## SERVICE INFORMATION LETTER

---

---

SIL NO. 1124-28-009

December 13, 1984

SUBJECT: WING FUEL PROBE GASKET, LEFT AND RIGHT OUTBOARD.

EFFECTIVITY: MODEL 1124, serial number 187 through 258.

A. REASON

To announce the availability of a new 653054-533 gasket that will increase the clearance and prevent contact between the wing fuel probe P/N 653505-507 and upper wing skin.

B. REFERENCES

1124 IPC, Chapter 28-40-00, Figure 3, Item 29A.

C. PUBLICATIONS AFFECTED

1124 IPC, Chapter 28-40-00, Figure 3, Item 29A, will be revised to reflect the new 653054-533 gasket.

D. DESCRIPTION

The new 653054-533 gasket is thinner than the 653054-505 gasket and prevents fuel probe contact (and possible shorting) with the upper wing skin.

SIL 1124-28-008  
Page 1 of 1



SUBSIDIARY OF ISRAEL AIRCRAFT INDUSTRIES, LTD.  
BEN GURION AIRPORT, ISRAEL

# 1124-WESTWIND

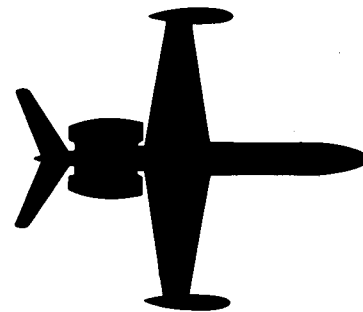

## SERVICE INFORMATION LETTER

---

---

SIL NO. 1124-28-020A

April 30, 1987

(This Service Information Letter No. 1124-28-020A dated April 30, 1987, supersedes Service Information Letter No. 1124-28-020 dated March 28, 1985 in its entirety.)

SUBJECT: FUEL - DUMP VALVE INTERCHANGEABILITY

EFFECTIVITY: MODEL 1124/1124A WESTWINDS, all serial numbers.

A. REASON

To permit interchangeability of fuel dump valve part numbers 653014-1 and 653014-501.

B. REFERENCES

None.

C. PUBLICATIONS AFFECTED

1124/1124A Illustrated Parts Catalog, Chapter 28-30-00 will be revised to reflect the availability of P/N 653562-27 bracket.

D. DESCRIPTION

The referenced fuel dump valves differ in width by .250". To allow interchangeability, P/N 653562-13 or 653562-23 check valve mounting brackets are replaced with two 653562-27 brackets. The replacement brackets are slotted to allow the 653562-1, -501 check valve to be shifted forward or aft sufficiently to allow either style dump valves to be installed. It is recommended that this modification (Figure 1) be accomplished at the next dump valve replacement.



SUBSIDIARY OF ISRAEL AIRCRAFT INDUSTRIES, LTD.  
BEN GURION AIRPORT, ISRAEL

SIL 1124-28-020A  
Page 1 of 2

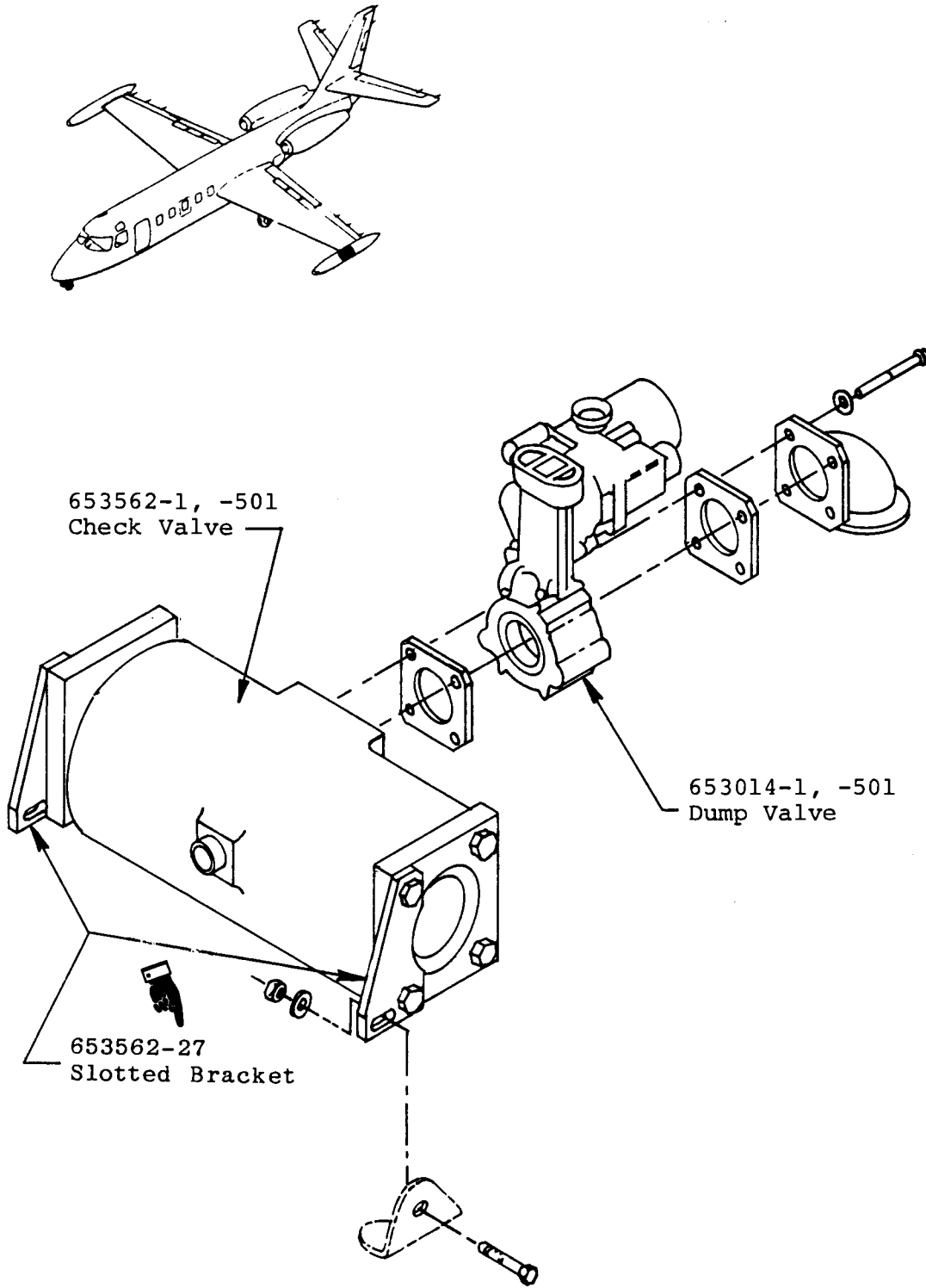
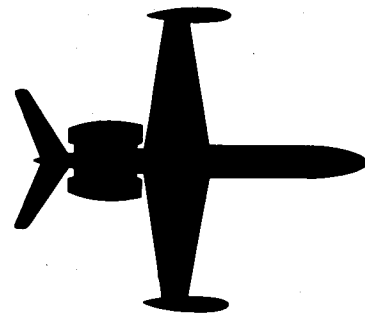

FIGURE 1 (RIGHT HAND SAME)

# **24-WESTWIND**



## **SERVICE INFORMATION LETTER**

---

---

SIL NO. 1124-28-026

March 20, 1985

**SUBJECT: REPLACEMENT OF FIREWALL FUEL SHUT-OFF VALVE LIGHT  
CIRCUIT RELAY**

**EFFECTIVITY: MODEL 1124/1124A WESTWINDS, serial numbers 187  
and subs.**

**A. REASON**

To avoid failure of indicator light circuit when fuel shut-off valve light diodes fail.

**B. REFERENCES**

1124/1124A Illustrated Parts Catalog, Chapter 28.

**C. PUBLICATIONS AFFECTED**

None.

**D. DESCRIPTION**

Part number 653572-501 diode failure in the fuel shutoff valve indicator light circuit usually causes damage to the MS27401-14 test light relay. It is therefore recommended to replace the MS27401-14 test light relay whenever the Firewall Shut-Off Valve P/N 6753572-501 is replaced.



SUBSIDIARY OF ISRAEL AIRCRAFT INDUSTRIES, LTD.  
BEN GURION AIRPORT, ISRAEL

SIL 1124-28-026  
Page 1 of 1

# 1124-WESTWIND

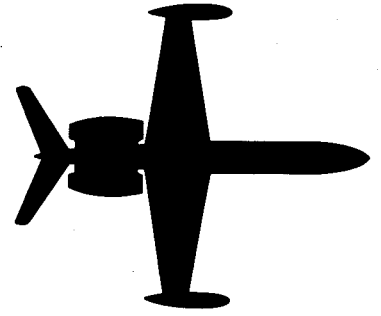

## SERVICE INFORMATION LETTER

---

SIL NO. 1124-28-062

February 7, 1986

SUBJECT: TO ANNOUNCE THE AVAILABILITY OF A NEW FUEL VENT VALVE

EFFECTIVITY: MODEL 1124/1124A WESTWINDS, all serial numbers.

A. REASON

Some operators have experienced difficulty with the fuel vent check valves sticking, allowing fuel to vent overboard.

B. REFERENCES

1124/1124A Maintenance Manual, Chapter 28-10-00.

C. PUBLICATIONS AFFECTED

1124/1124A Illustrated Parts Catalog will be revised to reflect new part numbers.

D. DESCRIPTION

An improved fuel vent check valve has been developed to replace present check valve P/N 653760-1 located in the wing and tip tanks. New P/N is 3653807-501 and may be purchased from Atlantic Aviation Supply Company, Wilmington, Delaware. Refer to 1124/1124A Maintenance Manual, Chapter 28-10-00 for removal and installation.

SIL 1124-28-062  
Page 1 of 1



SUBSIDIARY OF ISRAEL AIRCRAFT INDUSTRIES, LTD.  
BEN GURION AIRPORT, ISRAEL

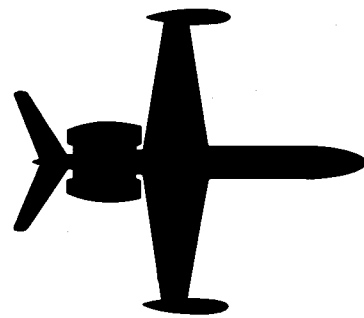

## **SERVICE INFORMATION LETTER**

**SERVICE INFORMATION LETTER NO. 1124-28-090**

**March 13, 1991**

**SUBJECT: FUEL - FUEL DUMP STOP LEVEL SWITCH PRECAUTIONS**

**EFFECTIVITY: MODELS 1124/1124A WESTWINDS, all serial numbers.**

**A. REASON:**

Recently an 1124 Westwind aircraft had to dump fuel before landing. The system did not stop dumping automatically due to shorted wires at the float switch connection.

**B. REFERENCE:**

1124/1124A Westwind Maintenance Manual, Chapter 28-20-00 and 28-30-00.

**C. PUBLICATIONS AFFECTED:**

1124/1124A Westwind Maintenance Manual, Chapter 28-20-00 and 28-30-00.

**D. DESCRIPTION:**

When maintenance necessitates removal of either the transfer start level switch or fuel dump stop level switches, maintenance personnel should ensure that wiring routed in conduit to these switches is free from shorts to ground and that the switches operate properly. Proper operation of the switch can be checked by ensuring the circuit to the switch is open when less than 900 lbs. of fuel is in the tank and closed with more than 1000 lbs.

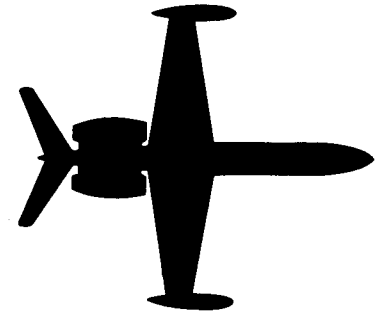

# SERVICE INFORMATION LETTER

---

SIL NO. 1124-28-103

REVISION 1

June 22, 1994

## TRANSMITTAL SHEET

This transmits Revision 1 to Service Information Letter No. 1124-28-103 dated May 25, 1994 titled, "Fuel - Improved Fuel Boost Pump."

### REASON FOR REVISION

To correct Fuel Boost Pump part number to 653744-507 and 653744.

This is a COMPLETE REVISION, replace all pages affected by this revision.

### LIST OF EFFECTIVE PAGES

<u>PAGE NO.</u>	<u>DATE</u>
1	June 22, 1994

### PREVIOUS REVISIONS OF SIL 1125-32-049

None.

# 24-WESTWIND

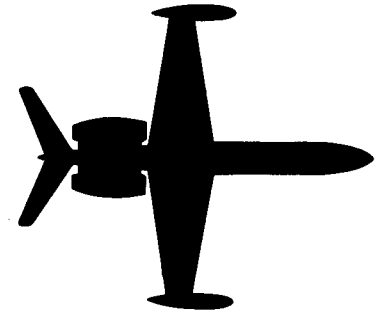

## SERVICE INFORMATION LETTER

SERVICE INFORMATION LETTER NO. 1124-28-103

May 25, 1994

**SUBJECT:** FUEL - IMPROVED FUEL BOOST PUMP

**EFFECTIVITY:** MODEL 1124/1124A WESTWIND, with Intertechnique Fuel Boost Pumps.

**A. REASON**

R  
R

To advise operators of availability of an improved Fuel Boost Pump P/N 653744-507 which is a direct replacement for Intertechnique Fuel Boost Pumps P/N 653744 (all dash numbers).

**B. REFERENCE**

None

**C. PUBLICATIONS AFFECTED**

1124/1124A Westwind Illustrated Parts Catalog, Chapter 28-20-00.

**D. DESCRIPTION**

R

Fuel Boost Pump P/N 653744-507 is an alternate replacement which can be installed in any position that an Intertechnique Boost Pump is currently installed. Pumps may be installed individually with no airframe modification required.

The alternate replacement pumps are being offered for their improved reliability and are available from Astra Jet Corporation.

R

May 25, 1994  
Revision 1, June 22, 1994  
1068

SIL 1124-28-103  
Page 1 of 1



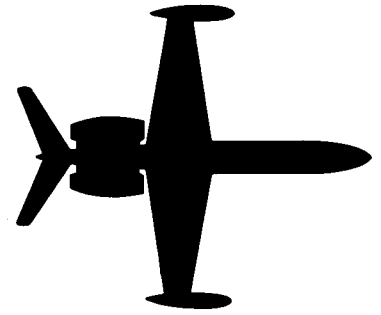

# SERVICE INFORMATION LETTER

---

SERVICE INFORMATION LETTER NO. 1124-28-103

May 25, 1994

**SUBJECT:** FUEL - IMPROVED FUEL BOOST PUMP

**EFFECTIVITY:** MODEL 1124/1124A WESTWIND, with Intertechnique Fuel Boost Pumps.

**A. REASON**

To advise operators of availability of an improved Fuel Boost Pump P/N 567344-507 which is a direct replacement for Intertechnique Fuel Boost Pump P/N 567344 (all dash numbers).

**B. REFERENCE**

None

**C. PUBLICATIONS AFFECTED**

1124/1124A Westwind Illustrated Parts Catalog, Chapter 28-20-00.

**D. DESCRIPTION**

Fuel Boost Pump P/N 567344-507 is an alternate replacement which can be installed in any position that an Intertechnique Boost Pump is currently installed. Pumps may be installed individually with no airframe modification required.

The alternate replacement pumps are being offered for their improved reliability and are available from Astra Jet Corporation.

# 1124-WESTWIND

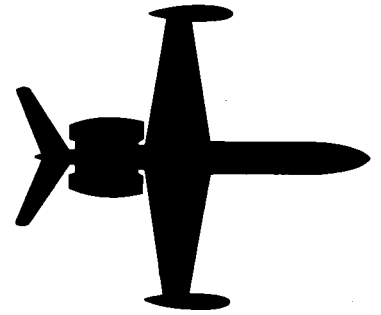

## SERVICE INFORMATION LETTER

---

SIL NO. 1124-29-051

May 27, 1985

SUBJECT: HYDRAULIC POWER - EMERGENCY HYDRAULIC PUMP SHAFT  
SEAL DRAIN FITTING - PROPER INSTALLATION INSTRUCTIONS

EFFECTIVITY: MODEL 1124 WESTWIND, all serial numbers.

A. REASON

To announce the availability of "installation instructions" for the emergency hydraulic pump shaft seal drain fitting that is scheduled to be incorporated in the next revision of the 1124 maintenance manual.

B. REFERENCES

None

C. PUBLICATIONS AFFECTED

Section III of the 1124 Series Maintenance Manual.

D. DESCRIPTION

The following precautions must be taken when installing the shaft seal drain fitting, P/N MS20823-D4, elbow:

1. Install the elbow fitting finger tight only. Over-tightening may distort the pump housing and alter pump vane clearances.
2. Do not use teflon thread tape on the pipe threads.
3. After installation, the fitting must not protrude into the housing but be flush with the inner surface to allow proper drainage of the shaft seal drain cavity.



SUBSIDIARY OF ISRAEL AIRCRAFT INDUSTRIES, LTD.  
BEN GURION AIRPORT, ISRAEL

SIL 1124-29-051  
Page 1 of 2

SERVICE INFORMATION LETTER NO. 1124-29-051

- a. Measure total length of pipe thread before fitting installation.
- b. Install fitting to pump housing finger tight.
- c. Measure exposed pipe threads.
- d. Determine proper thread length by adding length of exposed threads to thickness of the pump drive housing wall.
- e. If necessary, cut off excess thread length to ensure drain fitting is flush with cavity inner surface after installation.

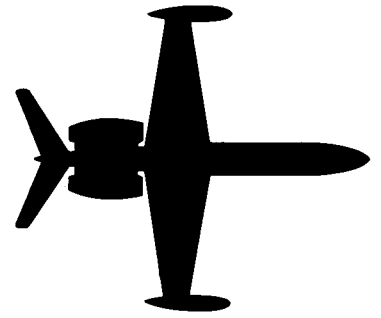

## SERVICE INFORMATION LETTER

---

---

SERVICE INFORMATION LETTER NO. 1124-29-067

October 31, 1986

SUBJECT: HYDRAULIC POWER - SUGGESTED INSPECTION METHODS FOR AFT  
FUSELAGE (STATION 316) HYDRAULIC LINES

EFFECTIVITY: 1124/1124A WESTWINDS, all serial numbers.

### A. REASON

To insure that the inspection of hydraulic fluid lines in the area of fuselage station 316 is performed so as to detect any interference or chafing with adjacent components.

### B. REFERENCES

1124/1124A Maintenance Manual, Chapter 5-20-05, paragraph H, Hydraulic System Components - Aft Fuselage.

### C. PUBLICATIONS AFFECTED

1124/1124A Maintenance Manual, Chapter 5-20-05, Paragraph H will be revised to add this information.

### D. DESCRIPTION

While inspecting for proper security and clearance between hydraulic fluid lines in the aft fuselage at station 316, it should be noted that flap flex drive shaft housings and aileron torque tubes may change relative position to hydraulic fluid lines during operation of either the flaps or aileron control systems.

It is strongly suggested that flaps and ailerons be operated through full limits of travel while inspecting all fluid lines, etc. for adequate clearance.

Undetected chafing may result in hydraulic line failure, causing complete hydraulic system fluid depletion.

# 24-WESTWIND

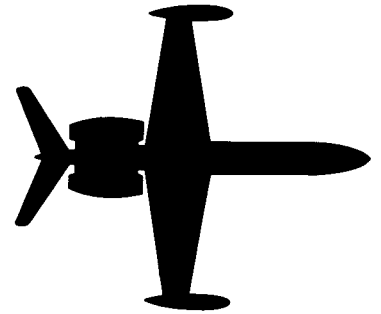

## SERVICE INFORMATION LETTER

SERVICE INFORMATION LETTER NO. 1124-29-074

September 8, 1989

**SUBJECT:** HYDRAULIC - APPROVED USE OF TEFLON BACK-UP O-RINGS

**EFFECTIVITY:** MODEL 1124/1124A WESTWIND, all serial numbers.

**A. REASON**

To allow an alternative of teflon back-up O-rings to replace leather back-up O-rings.

**B. REFERENCES**

Westwind Illustrated Parts Catalog, Chapters 27, 29, 32, and 78.

**C. PUBLICATIONS AFFECTED**

Westwind Illustrated Parts Catalog will not be revised to reflect this change.

**D. Installations of hydraulic fittings utilizing leather back-up O-rings are approved for use of teflon back-up O-rings. Use the following list to determine the correct alternative part number back-up O-ring for each installation.**

Leather P/N

S0311 - 904  
S0311 - 905  
S0311 - 906  
S0311 - 908  
S0311 - 910  
S0311 - 912  
S0311 - 916

Teflon P/N

MS28773 - 04  
MS28773 - 05  
MS28773 - 06  
MS28773 - 08  
MS28773 - 10  
MS28773 - 12  
MS28773 - 16

September 8, 1989



INTERNATIONAL INC.  
ISRAEL AIRCRAFT INDUSTRIES INTERNATIONAL INC.

SUBSIDIARY OF ISRAEL AIRCRAFT INDUSTRIES, LTD.  
BEN GURION AIRPORT, ISRAEL

SIL 1124-29-074

Page 1 of 1

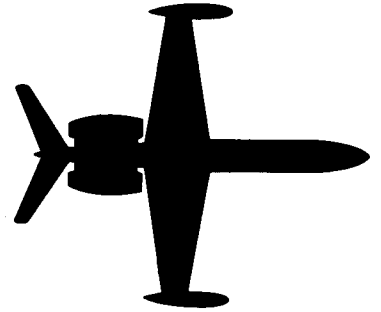

# SERVICE INFORMATION LETTER

---

---

SIL NO. 30

REVISION 1

April 12, 1995

## TRANSMITTAL SHEET

This transmits Revision 1 to Service Information Letter No. 30, dated February 28, 1983, titled, "Use of BIOBOR JF Fuel Additive."

### REASON FOR REVISION

To update SIL to contain current information.

This is a COMPLETE REVISION, remove all pages of previous issue of this SIL and replace with the new pages.

### LIST OF EFFECTIVE PAGES

<u>Page No.</u>	<u>Date</u>
1	April 12, 1995

### PREVIOUS REVISIONS OF SIL NO. 30

None.

April 12, 1995

Transmittal  
Page 1 of 1

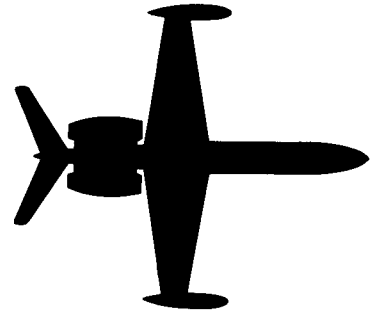

# SERVICE INFORMATION LETTER

---

---

SERVICE INFORMATION LETTER NO. 30

February 28, 1983

R     **SUBJECT:**           FUEL - USE OF BIOBOR® JF FUEL ADDITIVE

R     **EFFECTIVITY:**   MODEL 1124/1124A WESTWIND, all serial numbers

R     **A. REASON**

R           To advise operators of information concerning BIOBOR® JF fuel additive.

R     **B. REFERENCE**

R           1124/1124A Westwind Maintenance Manual, 12-10-01.  
R           Hammonds Fuel Additives Service Bulletin No. 979.

R     **C. PUBLICATIONS AFFECTED**

R           1124/1124A Westwind Maintenance Manual, 12-10-01.

R     **D. DESCRIPTION**

R           BIOBOR® JF aviation fuel additive prevents and treats fungal growth in  
R           aircraft fuel systems. This product is now owned and distributed by Hammonds  
R           Fuel Additives. Hammonds Fuel Additives Service Bulletin No. 979 (attached)  
R           discusses the subject of fungal growth in aircraft fuel systems and how to  
R           eliminate it with the help of BIOBOR® JF.

R           Fungal growth is not a problem in IAI model 1124/1124A Westwind aircraft,  
R           however, use of BIOBOR® JF is approved, ref. 1124/1124A Westwind  
R           Maintenance Manual, 12-10-01, Description/Operation.

February 28, 1983

R     Revision 1, April 12, 1995  
R     5243

SIL No. 30  
Page 1 of 1

# BIOBOR<sup>®</sup> JF

## Service Bulletin

The logo for Hammonds, featuring the word "Hammonds" in a stylized, bold font inside a rounded rectangular border.

BIOBOR<sup>®</sup> JF AVIATION FUEL ADDITIVE

No. 979

### I. INTRODUCTION

The following discussion and tables are presented on the subject of fungal growth in aircraft fuel systems and how to eliminate it with the help of BIOBOR<sup>®</sup> JF. It is simple to use and compatible with a wide variety of fuel system parts and top coatings, sealants and elastomeric materials. It does not adversely affect fuel performance. Chemical and physical properties are listed in Table I, blending data in Tables II, III and IV, and compatibility with fuel system components in Table V.

Due to the critical nature of fuel supply to an aircraft engine, it is important that this information be carefully read, particularly the section on blending, before attempting to use BIOBOR<sup>®</sup> JF. This product is a special formulation of glycol borates designed for maximum fungicidal effectiveness in hydrocarbon fuels and oils. In addition BIOBOR<sup>®</sup> JF is authorized by the FAA and recommended by both airframe manufacturers and engine manufacturers.

BIOBOR<sup>®</sup> JF works in both fuel and water. However, BIOBOR<sup>®</sup> JF must be kept from direct contact with excessive amounts of water to prevent hydrolysis of active ingredients into fuel insoluble materials. A complete discussion is given for proper handling and use. Should more information be needed, contact the technical service representative at Hammonds Fuel Additives, Inc. Office addresses and telephone numbers are listed at the end of this service bulletin.

BIOBOR<sup>®</sup> JF is registered with the EPA as a pesticide (EPA Reg. No. 65217-1).

BIOBOR<sup>®</sup> JF is recognized by a military specification number (MIL-S-53021).

### II. FUEL CONTAMINATION IN AIRCRAFT

#### A. Occurrence of the Problem

Surprisingly, several forms of fungi can survive and multiply in hydrocarbon fuels, especially the fuels consumed by jet aircraft. The microscopic growth occurs in all components of the fuel handling system—storage tanks, pumps, filters, delivery lines and ultimately, the jet aircraft fuel tanks. These fungi grow into long strings and form large mats or globules. The growth appears slimy, and usually is black, green or brown, although it may be any color. It may grow throughout the fuel, or at the interface area between the fuel and water bottom layer. As the fuel is agitated—for instance during filling—fungal growth is distributed throughout the fuel system, where it will cling tenaciously to walls and supporting structures.

The organism most commonly found in contaminated systems is *Cladosporium resinae*. It grows rapidly under widely varying conditions, needing only trace amounts of water and minerals to sustain itself. As it grows, it chemically alters the fuel to produce water, sludge, and acidic byproducts. It can attack and destroy fuel tank linings and hoses, and pit metals to the point where holes are formed. Other problems can also arise. Fuel tank gauging systems are favorite places for fungal growth and the adhering slime interferes with the operation of the indicating system to cause erratic readings. Filters also are affected, as the slimy material is very difficult to remove by the usual fuel filtering methods. The slime very quickly clogs filters, sometimes to the point of fuel starvation.

#### B. Detection of the Problem

Evidence of contamination may be seen on filters, tank surfaces, and pipelines as a dark slimy mass. The fuel may develop a smell of sulfur, similar to rotten eggs. Where there is no clear evidence, but contamination is suspected, there are biological methods for testing fuel. Among the most



convenient of these is the Hum-Bug Detector® Kit available from Hammonds Fuel Additives, Inc., Houston, Texas.

Whenever fuel tank areas are opened for a maintenance inspection, a visual examination should be made to determine the presence of slime on interior surfaces and particularly in the sump area where slime proliferates. Water, routinely drawn from sump areas, should also be inspected for slimy debris.

Erratic readings from fuel quantity probes may be due to an accumulation of slime deposits. Physical cleaning of the fuel probes may reduce the problem temporarily but regrowth very likely will occur resulting in faulty readings and further damage because of corrosion.

Positive findings of slime require immediate action to prevent further damage.

### **C. Prevention of the Problem**

The problem of fungicidal contamination in fuels can be alleviated by a two-step procedure:

1. Use of a fungicide, such as BIOBOR® JF, following the instructions given below.
2. Proper maintenance of the fuel handling system.

This is a key step because the effectiveness of even the most efficient fungicide can be reduced if the fuel is allowed to retain fungal debris and high excesses of water. Proper maintenance therefore requires regular removal of accumulated water bottoms and drainage of sump areas in addition to proper filtering to remove debris. Filters and screens should be inspected regularly. Storage tanks must be included in regular cleaning and inspection schedules. In some instances, good housekeeping may be all that is needed to prevent fungal growth. However, contamination occurs very easily, and even the best maintained system may need the assurance of BIOBOR® JF.

## **III. INSTRUCTIONS FOR USE OF BIOBOR® JF**

### **A. General**

Prepare the system before using BIOBOR® JF by checking the condition of the entire system. If fungal contamination has already occurred there may have been damage that should be repaired. In badly contaminated systems, as BIOBOR® JF kills the microbes, water, chemical and physical debris can be released that may further damage or clog the fuel system.

When adding BIOBOR® JF, consult the dosage charts (Tables II, III, and IV), or calculate the amount of BIOBOR® JF necessary to treat the fuel. For contaminated systems, or tanks prone to fungal attack, use the higher "shock" treatment level. This is calculated at 270 ppm BIOBOR® JF in fuel, or approximately one gallon of BIOBOR® JF for 5,000 gallons of turbine fuel.

For maintenance in new or previously treated tanks, a level of 135 ppm BIOBOR® JF or one gallon BIOBOR® JF in 10,000 gallons of turbine fuel, may be used. Exact usage will vary due to variations in weather, movement of fuel, and aircraft type. In general, use the lower level as long as the system is free of fungal growth. If contamination occurs, use the 270 ppm addition, or treat more often, or both. In no instance should BIOBOR® JF be used at more than 270 ppm in the fuel. Also, consult your aircraft manufacturers' operations manual for recommended frequency of usage.

When using BIOBOR® JF, check the filters frequently at first. Dying microorganisms will release specks of dirt and rust that have been caught in the mats. Also, the slime itself may come off walls and structures as it is killed. Once dead, the slimy nature of the fungus will disappear, and it should become more filterable.

Allow sufficient time and surface contact for BIOBOR® JF to work. Fuel that is treated and immediately flown off will not result in adequate control. Also, tanks that are not completely filled with treated fuel may not get protection above the fuel line. BIOBOR® JF does not vaporize from standing fuel, so it will go only where the fuel goes, and will burn off with the fuel. A contact time of 36-72 hours is recommended. If the aircraft must be used, refuel with BIOBOR® JF treated fuel to achieve the required contact time.

## **B. Blending**

**CAUTION:** Turbine fuel, by its nature, always contains some water. Always be sure fuel has been properly maintained and filtered to remove water and debris. BIOBOR® JF is a mixture of glycol borates, and under certain conditions (high BIOBOR® JF concentrations), will hydrolyze in fuel-water systems to form solid crystalline products. To avoid the possibility of solids formation, care must be taken to avoid adding BIOBOR® JF to fuel containing excess moisture, and to avoid using BIOBOR® JF above a concentration of 1,000 ppm (equivalent to 0.1%, or about 3.8 gallons BIOBOR® JF to 5,000 gallons of fuel) even when preparing BIOBOR® JF fuel concentrates. Glycol borates are soluble in both the water and fuel phases of the system. For practical purposes, a partition coefficient of 250:1 water to fuel distribution can be assumed. In the presence of very low concentrations of water in fuel, BIOBOR® JF is essentially contained in the fuel phase. With BIOBOR® JF at its recommended level of 270 ppm, there will be no problem of solids formation. However, in the presence of excess water, either through direct dilution of BIOBOR® JF with water, or by adding BIOBOR® JF to "wet" fuel, i.e., fuel from a sump area, formation of solids may occur.

If BIOBOR® JF concentration in fuel is maintained below 1,000 ppm, it has been shown that solid formation will not occur, even in "wet" fuel. However, above 1,000 ppm of BIOBOR® JF in fuel, water concentration becomes a factor and in laboratory tests, amounts of water in excess of 1,000 ppm added to the fuel treated with BIOBOR® JF caused formation of solids. ASTM standards note the maximum recommended limit for water in jet fuel not exceed 30 ppm.

For reasons noted above, we strongly recommend the use of a metered injection system for BIOBOR® JF addition to aviation turbine fuel. Metered injection eliminates problems associated with batch-blending and over-the-wing addition. Also, it ensures continuous dilution at the correct level in a flowing stream of fuel. Complete dispersion is obtained immediately, which is especially important in wing tanks with baffles and in aircraft where fuel cannot be recirculated to promote mixing.

Over the wing treatment in aircraft that do not have recirculation devices may lead to chronic undertreatment, or lack of treatment, in some areas of the fuel tank. This will result in lack of fungal control in those areas. Therefore, a Hammonds Additive Injection System is highly recommended, contact Hammonds Technical Services, Inc. at (713) 442-4074 for an additive injection system distributor nearest you.

If metered injection is not possible, and the only alternatives are batch-blending or over-the-wing addition, further precautions should be taken. When batch-blending, calculate the amount of BIOBOR® JF needed for treatment, and prepare a batch that does not exceed the 1,000 ppm concentration. Use a large container and be sure that it is free of dirt, water and other contaminants. Fill the container one-half full with fuel first, then continue adding fuel and BIOBOR® JF at the same time to ensure proper dispersion. To insure proper dilution below 1,000 ppm, a tank truck may be required for mixing.

When adding BIOBOR® JF over the wing, fill the wing tank about half-full with fuel first, then add BIOBOR® JF slowly during addition of the remaining fuel. This will help bring about dispersion, and avoid areas of high concentration. Never add BIOBOR® JF to an empty tank.

Table II will serve as an aid in calculating the amount of BIOBOR® JF to blend with turbine fuel to obtain concentrations of 270 and 135 ppm. For jet fuel, a density of 6.7 pounds per gallon is used as a basis for the calculation. Density of BIOBOR® JF is 8.75 pounds per gallon.

## **C. Storage Tank Treatment**

BIOBOR® JF may be added to storage tanks following the same precautions as outlined above. Again, metered injection into the incoming stream of fuel is the preferred method. BIOBOR® JF should never be added directly into water bottom areas nor should it be used as a tank wall cleaning agent. It is designed for use as a fuel additive only. When treating storage tanks, be sure that all aircraft to receive fuel from that tank have approval for BIOBOR® JF use.

**D. Storage and Handling of BIOBOR® JF Containers**

BIOBOR® JF containers should be protected from water. Containers must be capped tightly when not in use, as prolonged exposure to atmospheric moisture can cause formation of solids and loss of effectiveness. To avoid prolonged storage of containers that have been opened, choose a size most suitable to your needs.

Before use, clean the lid area of dust and dirt. Discard if product is discolored or contains solids. **DO NOT TRANSFER BIOBOR® JF TO OTHER CONTAINERS FOR STORAGE.**

BIOBOR® JF is presently available in 16 ounce, one quart, five gallon and fifty-five gallon non-returnable containers. 16 ounce Easy Squeeze containers are sold twelve bottles per case. Quarts are sold six per case.

**TABLE I  
BIOBOR® JF PRODUCT DATA**

**Chemical Composition  
Active Ingredients**

2,2'-oxybis (4, 4, 6-trimethyl - 1, 3, 2-dioxaborinane)  
2,2'-(1-methyltrimethylenedioxy) bis-(4-methyl 1-1, 3,2-dioxaborinane) ..... 95.0%

**Inert Ingredients**

Petroleum Naptha ..... 4.5%  
Inerts ..... 0.5%  
TOTAL: ..... 100%  
Boron Content ..... 7.3%

**Physical Properties (typical)**

Flash Point, TCC (Tag Closed Cup) ..... 104 ± 2° F.  
Density ..... 1.05g/cc @ 68° F.  
Pour Point ..... -27° F.  
Color (ASTM) ..... 0.5.

**TABLE II  
BIOBOR® JF DOSAGE LEVELS  
(FUEL = U.S. GALLONS)**

JET FUEL		SHOCK TREATMENT MAINTENANCE LEVEL			
		@ 270 PPM		@ 135 PPM	
Lbs.	Gals.	Gals.	Fl. Ozs.	Gals.	Fl. Ozs.
670	100	0.02	2.63	0.01	1.32
1,340	200	0.04	5.26	0.02	2.63
2,010	300	0.06	7.89	0.03	3.95
2,680	400	0.08	10.53	0.04	5.26
3,350	500	0.10	13.16	0.05	6.58
6,700	1,000	0.21	26.46	0.10	13.16
13,400	2,000	0.41	52.92	0.21	26.46
16,750	2,500	0.52	66.08	0.26	33.04
33,500	5,000	1.03	132.16	0.52	66.08
67,000	10,000	2.07	264.47	1.03	132.31
134,000	20,000	4.14	528.94	2.06	264.62
335,000	50,000	10.35	1,322.35	5.15	661.55

To determine the fluid ounces of BIOBOR® JF required to give a concentration of 270 ppm, multiply pounds of fuel by 0.004 and for 135 ppm by 0.002.

Density of Jet Fuel: 1 gallon weighs 6.714 pounds.

**TABLE III**

**BIOBOR® JF DOSAGE LEVELS  
METRIC EQUIVALENTS**

<b>TURBINE FUEL*</b>		<b>BIOBOR® JF (270 ppm)**</b>	<b>BIOBOR® JF (135 ppm)**</b>
<b>U.S. GAL.</b>	<b>LITERS</b>		
100	378.5	80 ml	40 ml
300	1135.5	236 ml	118 ml
625	2365.6	473 ml	236 ml
1250	4731.3	946 ml	473 ml

\*Assuming fuel density of 0.804g/ml

\*\*BIOBOR® JF density = 1.05g/ml

**TABLE IV**

**BIOBOR® JF METRIC CONVERSIONS FOR VARIOUS FUELS  
"SHOCK TREATMENT" AT 270 PPM**

<b>FUEL</b>	<b>g/ml</b>	<b>Fuel Density at 15° C / 59° F</b>		<b>Oz. of BIOBOR® JF per 1000 gal. fuel</b>	<b>ml of BIOBOR® JF per 1000 liters fuel</b>
		<b>lbs/gal*</b>	<b>kg/L</b>		
JP-4	0.7601	6.343	3.694	25.37	198.27
Kerosene (Turbine Fuel)	0.8045	6.714	3.910	26.86	209.57
Diesel #1	0.8180	6.827	4.002	27.31	214.50
Diesel #2	0.8484	7.080	4.123	28.32	220.99
Bunker "C"	0.9952	8.305	4.837	33.22	259.26

To determine the fluid ounces of BIOBOR® JF required to give a concentration of 270 ppm, multiply pounds of fuel by 0.004 and for 135 ppm by 0.002.

To determine milliliters of BIOBOR® JF required to give a concentration of 270 ppm, multiply kilograms of fuel by .0536 and for 135 ppm by .0268.

\*Computed from fuel densities as surveyed by the American Petroleum Institute.

## TABLE V

### BIOBOR® JF COMPATIBILITY WITH FUEL SYSTEM COMPONENTS\*

BIOBOR® JF IS COMPATIBLE WITH:

#### I. Top Coatings and Sealants

1. Buna-N (EC-7765-R)
2. Polyurethane PR-1560
3. PR-1422 (Thiokol type)
4. PR-703 Products Research Corporation
5. PR-1422 Products Research Corporation
6. Pro Seal-890 Coast Pro Seal Company
7. PR-9021 Products Research Corporation
8. Pro Seal-719 Coast Pro Seal Company
9. Z9-0048 Dow Corning Corporation

#### II. Fuel Cell Materials

- |                    |                              |
|--------------------|------------------------------|
| 1. Estane 580029   | B.F. Goodrich                |
| 2. BTC-17-10       | Goodyear                     |
| 3. BTC-12-3        | Goodyear                     |
| 4. BTC-49          | Goodyear                     |
| 5. BTC-54A         | Goodyear                     |
| 6. BTC-67          | Goodyear                     |
| 7. BTC-85          | Goodyear                     |
| 8. BTC-86          | Goodyear                     |
| 9. 10740SR         | Firestone                    |
| 10. LS-53 Silicone | Dow Corning Corporation      |
| 11. MIL R-6855     | Precision Components         |
| 12. US-566R/RL     | UNIROYAL (nitrile materials) |
| 13. US-943         | UNIROYAL (nitrile materials) |

#### III. Metal Alloys

- |                     |           |
|---------------------|-----------|
| 1. SAE 1010         | Steel     |
| 2. AZ92             | Magnesium |
| 3. 2024             | Aluminum  |
| 4. 4015             | Aluminum  |
| 5. 7178             | Aluminum  |
| 6. 7075             | Aluminum  |
| 7. Cad plated steel |           |

#### IV. Fuel Tank Gauging Systems

1. Approval by Minneapolis Honeywell
2. Approval by Simmonds Precision Products
3. Approval by Liquidometer Corporation
4. Approval by Consolidated Airborne Systems

BIOBOR® JF is not compatible with Lexan polycarbonate. BIOBOR® JF at full strength may not be compatible with some polymeric materials. TEFLON is recommended for gaskets and/or O-rings where exposure to neat BIOBOR® JF is anticipated.

\*Testing was done at recommended use dilution or two times use dilution.

**COMPANIES WHICH RECOMMEND THE USE OF BIOBOR® JF**

**AIRCRAFT MANUFACTURERS**

Gulfstream Aerospace Corp.  
Boeing Aircraft  
Beechcraft Aircraft Corp.  
Dassault Falcon Jet  
Bell Helicopter  
Fokker Aircraft Corp.  
LearJet Corporation  
Lockheed Aircraft Company  
Sikorsky Helicopter  
Israel Aircraft Industry Ltd.  
Hughes Helicopter  
British Aerospace Aircraft  
McDonnell Douglas Aircraft  
Saberliner Aircraft Corp.

**AIRCRAFT ENGINE MANUFACTURERS**

Rolls Royce Engines  
Lycoming Engine Corporation  
Pratt & Whitney Engines  
Allison Industries  
Garrett Aircraft Engines  
General Electric Engines Division  
Allied Signal Aerospace Corp.

**DIESEL ENGINE MANUFACTURERS**

Detroit Diesel Corp.  
Caterpillar Tractor Corp.  
International Harvester Tractor Co.  
Waukesha/Dresser Engines  
Cummins Engine Co., Inc.  
General Motors - Diesel Engine Division  
Mercedes Benz  
John Deere Tractor

**ENGINE ACCESSORIES AND FUEL  
MONITORING EQUIPMENT  
MANUFACTURERS**

Dahl Filter Corporation  
Velcon Filters, Inc.  
Stanadyne Filter/Fuel Injection  
Systems  
Airborne Fuel Filters  
Consolidated Airborne Systems  
Liquidometer Corporation  
Minneapolis Honeywell  
Simmonds Precision Products  
Facet Filter Corporation

**FUEL SERVICE COMPANIES**

Paulsen Industries  
National Biocide Services  
I.C.E.S., Inc.

**TANK MANUFACTURERS**

Uniroyal Tank and Plastic  
Production Division  
Goodyear Aerospace  
U.S. Steel Tank  
Firestone Tank Division  
Dow Corning Tanks  
A.O. Smith Fiberglass  
Tank Corp.  
BF Goodrich Aerospace

The OEM's listed above suggest the use of BIOBOR® JF as part of their standard maintenance programs. This endorsement appears in the Equipment Maintenance Manuals under Engine, Airframe or Fuel System Care.



**HAMMONDS FUEL ADDITIVES, INC.**  
P.O. BOX 38114-407 • HOUSTON, TEXAS 77238-8114  
(713) 442-3777 • FAX: (713) 442-3974

**NOTICE: THERE ARE NO WARRANTIES, EXPRESS OR IMPLIED INCLUDING ANY WARRANTY OF FITNESS FOR A PARTICULAR PURPOSE, WHICH EXTEND BEYOND THE DESCRIBED USES IN THIS BULLETIN.**

**WARNING: ON ALL PRODUCTS, AVOID PROLONGED INHALATION OR PROLONGED SKIN CONTACT. NOT FOR FOOD OR DRUG USE. READ ALL INSTRUCTIONS RELATING TO THE PRODUCTS BEFORE USE.**

If possible uses of these products have been mentioned herein, it is not intended that the above products be used to practice any applicable patent, whether mentioned in this Bulletin or not, without procurement of a license, if necessary, from the owner, following investigation by the user.

©1992. All Rights Reserved.

# 1124-WESTWIND

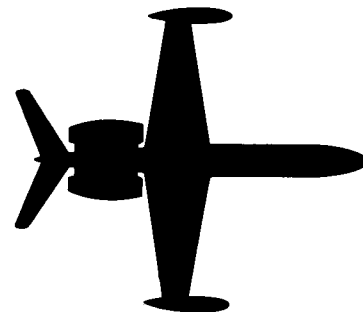

## SERVICE INFORMATION LETTER

---

---

SIL NO. 1124-30-003

November 19, 1984

SUBJECT: PITOT AND AOA HEAT LIMITATIONS

EFFECTIVITY: MODEL 1124/24A WESTWINDS serial numbers 214, 221, 246, 258, 266, 294 and Subs.

A. REASON

To prevent probe heater burnouts.

B. DESCRIPTION

- (1) The above operators should be reminded that the pitot, static, and/or TAS and AOA probe heaters will be ON anytime the nose strut is extended (oleo switch actuator) OR when the pitot/static heat switch is placed in OVRD.
- (2) A/C S/N prior to 294, please observe the same precautions; since system heaters are on the right MLG uplock a retraction test will activate heaters, even with pitot heat OFF.
- (3) Should this condition exist for any reason, during maintenance procedures, it WILL be necessary to pull the four system circuit breakers described above to prevent accidental system damage, or personal injury while the aircraft is on the ground.
- (4) 1124A operators (295 & subs.) must take special note that the AOA probe, has no internal thermostat protection, and is limited to 2 minutes ON time during ground operation or maintenance.

November 19, 1984



SUBSIDIARY OF ISRAEL AIRCRAFT INDUSTRIES, LTD.  
BEN GURION AIRPORT, ISRAEL

SIL 1124-30-003  
Page 1 of 2



SERVICE INFORMATION LETTER 1124-30-003

- (5) Another reminder is to turn Pitot Heat OFF, as Flight and Operations restrictions permit, or, if Pitot heat is required, to pull the AOA probe heat breaker. This is to ensure that AOA probe heat is disabled during non-icing conditions (above approximately 40° F) to prevent probe burnout during high OAT conditions which might exceed the 2 minute limitation.

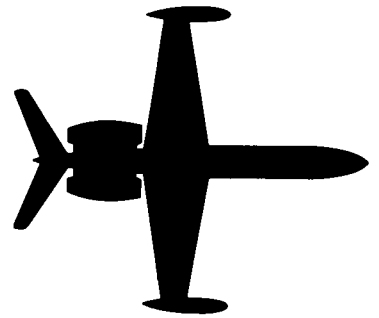

# SERVICE INFORMATION LETTER

---

SERVICE INFORMATION LETTER NO. 1124-30-080

May 29, 1990

**SUBJECT:** ICE AND RAIN PROTECTION - ENGINE HP BLEED  
MANIFOLD ASSEMBLY

**EFFECTIVITY:** MODEL 1124/1124A WESTWIND, all serial numbers.

**A. REASON**

To inform operators of the availability of a new bleed manifold assembly, P/N F10A5P20242-9.

**B. REFERENCE**

None.

**C. PUBLICATIONS AFFECTED**

1124/1124A Westwind Illustrated Parts Catalog, Chapter 30-20-00.

**D. DESCRIPTION**

Due to field reports of a high failure rate of the F10A5P20242-7 bleed manifold assembly, a new manifold, P/N F10A5P20242-9 has been designed which has a reinforcement saddle welded in the area where the engine anti-ice line attaches. Undamaged and cracked -7 manifold assemblies may be exchanged through Atlantic Supply Company for the -9 configuration if the damage limitations set forth by the manufacturer are not exceeded. Broken -7 manifold assemblies are not exchangeable.

# SERVICE LETTER

**SUBJECT: TIMKEN PERFORMANCE CODE 629 FOR BEARING CUPS AND BEARING CONES**

## SECTION I - PLANNING INFORMATION

- A. **EFFECTIVITY:** This Service Letter is applicable to all Aircraft Braking Systems Corporation (ABSC) Wheel Assemblies.
- B. **REASON:** The Timken Company identifies certain bearing cups and bearing cones used on ABSC wheel assemblies with Performance Code 629.
- C. **DESCRIPTION:** This Service Letter is issued to tell operators what the Timken Performance Code 629 is and how to identify bearing cups and bearing cones that were made to the Timken Performance Code 629 specification. This Service Letter also tells operators which ABSC wheel assemblies must use the Timken Performance Code 629 bearing cups and bearing cones. This Service Letter supersedes General Service Letter GS-SL-9.
- D. **APPROVAL:** This Service Letter contains no modification information that revises the approved configuration and therefore does not require government or other regulatory agency approval.
- E. **WEIGHT AND BALANCE:** None.
- F. **REFERENCE:**
  - (1) All Component Maintenance Manuals and Overhaul Manuals for Aircraft Braking Systems Corporation Wheel Assemblies used on Commercial, Military and General Utility Aircraft.
  - (2) General Service Letter GS-SL-9 (basic issue dated Feb 9/83) for Aircraft Wheel Bearing Class Numbers.

## SECTION II - ACCOMPLISHMENT INSTRUCTIONS

- A. Timken Performance Code 629:

A Performance Code as told by the Timken Company is "a set of manufacturing instructions that differentiate a component from standard product in order to meet specific requirements of the customer." The differences between the standard bearing cups and bearing cones and those bearing cups and bearing cones identified by Timken Performance Code 629 are:

- (1) Cup races, cone races and roller bodies are honed to improve contact surface finish.
  - (2) Cups and cones are 100% examined for correct hardness.
  - (3) Special quality control measures are done when the bearing cups and bearing cones are made.
  - (4) Bearing cups and bearing cones that are approved by Timken Performance Code 629 are identified as "2-629" or "4-629" adjacent to the part number. The first digit is the bearing class (2 or 4) and the last three digits indicate the performance code.
- B. ABSC lets Timken Performance Code 629 bearing cups and bearing cones be used on all ABSC wheel assemblies. Refer to Figure 1 for the Timken Performance Code 629 approved bearings. However, the installation of Timken Performance Code 629 bearing cups and bearing cones is mandatory in all of the ABSC wheel assemblies shown in Figure 2 and in all ABSC wheel assemblies where the Component Maintenance Manual or Overhaul Manual has specified that Timken Performance Code 629 components must be used.

Feb 18/94

(RELEASED: AA 2/18/94)

GS-SL-38  
Page 1 of 3

**AIRCRAFT BRAKING SYSTEMS**  
Corporation

CONE	CUP	CONE	CUP	CONE	CUP	CONE	CUP
385	382	XC25710C		52400	52618	M229349	M229310
385A	382A	XC25727C	XC25727D	52400A		L305649	L305610
387		27684	27620	64433	64700	L319249	L319210
395-S	394A	27687		LM67048	LM67010	LM328448	LM328410
399A		27690		68462	68712	LL428349	
495A	492A	27695		71450		LM503349	
497	493S	28682	28622	L102849	L102810	L507945	L507910
594	592A	29585	29520	LL103049	LL103010	L507949	
596	592AX	29586	29523	LM104949	LM104911	JLM508748	JLM508710
643	632A	29590		LM114848	LM114811	LM522546	LM522510
644		29685	29620	LM117949	LM117910	LM522549	
685		LM29749	LM29710	LM120749	LM120710	LM522549H	
XC2399CF		33251	33462	LM121349		L610549	L610510
XC2455CF		34301	34478	LM122947V		JM612949	JM612910
XC2527CF		39250	39412	LM122948		LM613449	LM613410
3984	3920		39422	LM124448		L713049	L713010
XC02638CB		42350	42584	LM124448V		LL713049	LL713010
07100-S	07196	42687A	42620	LM125748	LM125711	LM718947	LM718910
08125	08231	42690H		LM125748AV	LM125711V	JM720249	
JP13049	JP13010	L44649	L44610	LL205442	LL205410	L725349V	L725311V
	13318	L45449	L45410	L205449		L730649	L730610
13685	13621A	47688	47620	M224749	M224711	LM806649	LM806610
13889	13830	47896	47820		M224713A	L812148	L812111
	13836	48190	48120	LL225749		JLM813049	JLM813010
14137A	14276	48282	48220	L225849	L225810	HM813844	HM813810
18790	18720	48290		LM229136C	LM229110	L814749	L814710
19150	19268	48385	48320	LM229140C		LM814849	LM814810
XC25433C	XC25433DA	LM48548	LM48510	LM229147C		JLM820048	
XC25697C	XC25697D	48685	48620				

Timken Bearing Part Numbers made to Performance Code 629  
Figure 1

MANUFACTURER	MODEL/SERIES	WHEEL ASSEMBLY			
		MAIN/CENTER		NOSE	
		INBOARD	OUTBOARD	INBOARD	OUTBOARD
McDonnell Douglas	MD90	Yes	No	No	No
SNIAS	A321	Yes	Yes	—	—
	A330	Yes	Yes	—	—
	A340	Yes	Yes	—	—

**NOTE:** These aircraft must use Timken's Performance Code 629 bearing cups and bearing cones in the wheel halves shown ("Yes").

Wheel Assemblies That Must Use Timken Performance Code 629 Bearing Components  
Figure 2

- (1) Timken Performance Code 629 bearing cups and bearing cones will be added as alternate parts in the next revision of all applicable Component Maintenance Manuals and Overhaul Manuals.

**NOTE:** For wheel assemblies where the use of Timken Performance Code 629 bearing cups and bearing cones is mandatory, the Component Maintenance Manual or Overhaul Manual will be changed to only show the "2-629" or "4-629" bearing cup and bearing cone.

- (2) To order Timken Performance Code 629 bearing cups and/or bearing cones it is necessary to give the information that follows:
- (a) The correct bearing cup/cone part number.
  - (b) The correct bearing class (Class 2 or 4).
  - (c) The Performance or Inspection Code "629".

**NOTE:** The Timken Company does not include the "2-629" or "4-629" identification as part of the part number.

**CAUTION:** ♦ DO NOT USE STANDARD BEARING COMPONENTS IN A WHEEL SUBASSEMBLY THAT MUST HAVE TIMKEN PERFORMANCE CODE 629 BEARING COMPONENTS INSTALLED. SEE FIGURE 2 AND THE APPLICABLE COMPONENT MAINTENANCE MANUAL OR OVERHAUL MANUAL.

- (3) Bearing cups or bearing cones that do not have the Timken Performance Code 629 can be used with bearing cones or bearing cups that do have the Timken Performance Code 629 only on aircraft where it is not mandatory to use Timken Performance Code 629 parts (See Figure 2 or the applicable Component Maintenance Manual or Overhaul Manual).

**SECTION III – MATERIAL INFORMATION**

A. Not applicable.

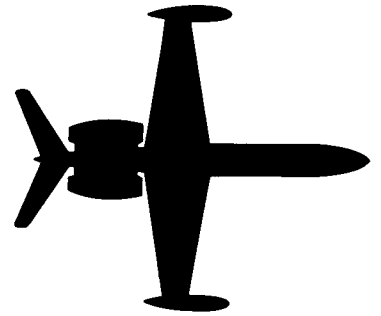

# SERVICE INFORMATION LETTER

---

SERVICE INFORMATION LETTER NO. 1124-32-100

September 1, 1993

**SUBJECT:** LANDING GEAR - WHEEL INSPECTION AND OVERHAUL  
SCHEDULES

**EFFECTIVITY:** MODEL 1124/1124A WESTWIND, all serial numbers.

**A. REASON**

To provide information regarding Aircraft Braking Systems guidelines for wheel inspection and overhaul.

**B. REFERENCE**

ABSC General Service Letter GS-SL-36.

**C. PUBLICATIONS AFFECTED**

None

**D. DESCRIPTION**

Aircraft Braking Systems Corporation has issued General Service Letter GS-SL-36 which discusses guidelines which may be applied by operators of aircraft equipped with ABSC wheel assemblies.

This General Service Letter is issued to give operators guidelines for inspection and overhaul increments. It is not mandatory for operators to use the overhaul increments given in this Service Letter. Experienced operators can better predict the overhaul increments and determine procedures to be done at each overhaul. This Service Letter also gives a guide for a start-up maintenance program.

For a copy of ABSC General Service Letter GS-SL-36, contact:

Aircraft Braking Systems Corp.  
Publications Department  
1204 Massillon Road  
Akron, OH 44306

216-796-8081 - Office  
216-796-9805 - Fax

# SERVICE LETTER

SUBJECT: WHEEL INSPECTION AND OVERHAUL SCHEDULES

## SECTION I – PLANNING INFORMATION

- A. EFFECTIVITY: This General Service Letter is applicable to all Aircraft Braking Systems Corporation wheel assemblies used on various aircraft.
- B. REASON: The increment between overhauls varies greatly for each wheel assembly. Experienced operators know the operation of their equipment and the inspection results. Where such experience is not available, it is necessary for operators to have guidelines to determine when normal overhaul procedures must be done on a wheel assembly.
- C. DESCRIPTION: This General Service Letter is issued to give operators guidelines for inspection and overhaul increments. It is not mandatory for operators to use the overhaul increments given in this Service Letter. Experienced operators can better predict the overhaul increments and decide what procedures should be done at each overhaul. This Service Letter gives a guide for a start-up maintenance program.

## NOTICE

AIRCRAFT BRAKING SYSTEMS CORPORATION (ABSC\*) ASSUMES NO CONTRACTUAL, WARRANTY, PRODUCT LIABILITY OR OTHER OBLIGATION FOR ANY SUBSTITUTION OF OR ALTERATION TO ANY PART CONTAINED IN ANY ABSC WHEEL OR BRAKE ASSEMBLY INCLUDING ACCESSORIES NOT SPECIFICALLY AUTHORIZED BY ABSC OR FOR ANY ALTERATION NOT PERFORMED IN ACCORDANCE WITH ABSC APPROVED PROCEDURES.

- D. APPROVAL: This General Service Letter contains no modification information that revises the approved configuration and therefore does not require government or other regulatory agency approval.
- E. WEIGHT AND BALANCE: None.
- F. REFERENCE: All Aircraft Braking Systems Corporation Overhaul and Component Maintenance Manuals for all wheel assemblies.

## SECTION II – ACCOMPLISHMENT INSTRUCTIONS

- A. GENERAL INFORMATION:
  - (1) Aircraft Braking Systems Corporation (ABSC) aircraft wheel assemblies are manufactured to the highest quality standards.
    - (a) As with all aircraft components, the probability of fatigue failure for a wheel assembly increases as the service time of a wheel assembly increases. In addition, too much tire pressure, poor landing conditions, runway obstacle impacts, corrosion, surface damage, and incorrect wheel maintenance can decrease the service life of the wheel assembly. It is for these reasons that the length of inspection and overhaul increments decreases as the wheel service time increases.
    - (b) ABSC wheel assemblies are designed to give a long and reliable service life when correctly maintained as told in the appropriate Component Maintenance Manual (CMM).
    - (c) The CMM's give all the necessary inspection and repair procedures for normal maintenance of wheel assemblies. The CMM's do not give a specific increment for when these procedures must be done.

\* ABSC is the registered trademark of Aircraft Braking Systems Corporation

Jul 19/93

(RELEASED: *CD 7/26/93*)

GS-SL-36  
Page 1 of 7

- 1 Many airlines have asked for specific inspection/overhaul increments, but the Air Transportation Association (ATA), Specification 100, states:

Time limits (including shelf life components) for scheduled inspections or checks in the procedures are specifically prohibited unless required by government regulation. Airlines do desire manufacturer's recommendations, but if provided they must be in a separate document.

- 2 It is the purpose of this Service Letter to give ABSC's recommendations on inspection/overhaul increments.

(2) Wheel Inspection and Overhaul Procedures:

- (a) The ultrasonic and eddy current inspection procedures given in the CMM's have a reliability of 95 percent and 90 percent respectively. The reliability factor of these methods has a relation with the knowledge, accuracy and experience of the operator.
- (b) This Service Letter gives the wheel inspection and overhaul procedures that must be done at each maintenance increment to make sure the wheel assembly is correctly maintained. The maintenance increments are calculated to optimize the wheel service life and economic factors.

B. INSPECTION FREQUENCIES:

- (1) As told in all ABSC Component Maintenance Manuals, each operator must schedule maintenance based on the condition of his equipment. ABSC recommends that on-condition maintenance be performed.
  - (a) The World Airlines Technical Operations Glossary (WATOG) defines on-condition maintenance as follows:

A primary maintenance process having repetitive inspections or tests to determine the condition of units, systems or portions of structure with regard to continued serviceability (corrective action is taken when required by item condition).
- (2) ABSC cannot accurately create a "formula" to predict wheel retirements or recommend increments for wheel inspections and overhaul because of the variables that follow:
  - (a) The amount of scatter in the frequency of wheel retirements between operators.
  - (b) Repairs done to the wheel assembly and upgrades to the wheel assembly also change the length of the wheel service life.
  - (c) The operation environment and the maintenance practices, which have a direct relationship with wheel service life, differ for each operator.
- (3) Operators who know more about the wheel's service life history can create their own inspection and overhaul schedules.
- (4) For other operators, ABSC recommends the operators use the information given in this Service Letter to make wheel inspection and overhaul schedules.

**NOTE:** On-condition maintenance remains the primary recommendation of ABSC.



- (5) ABSC recommends that operators use the comments given below when they make inspection and overhaul schedules for their wheel assemblies:
- (a) It is recommended that operators with established inspection and overhaul schedules continue to use their inspection schedules.
  - (b) The guidelines given in this Service Letter are intended to help operators make their own inspection and overhaul schedules. These guidelines must be changed to correspond to the actual service history of a particular wheel assembly.
  - (c) Aircraft wheels are highly stressed components that are sensitive to handling damage and maintenance procedures. Aircraft wheels have a finite life which can be maximized by careful handling. Operators must do only the maintenance procedures given the CMM in order to maximize the service life of the wheel.
  - (d) It is recommended that an eddy current inspection of the bead seat area of all wheel assemblies be made at each tire change if the eddy current inspection equipment is available. Otherwise, an eddy current inspection or ultrasonic inspection of the wheel halves must be made at each overhaul.
  - (e) When wheel halves with different amounts of wear are used in the same wheel assembly, the inspection schedule for the most worn wheel half must be used.
  - (f) If the service history of the wheel assembly (or one of the wheel halves) is not known, the wheel assembly must be overhauled at each tire change.
  - (g) Maintenance records must be kept for each wheel subassembly to make the maintenance schedules effective. This will make sure that the maintenance of the wheel halves is not lost. Include the information that follows in the maintenance record: repairs done to the wheel half, total accumulated mileage, the total number of landings and the number of tire changes.
  - (h) Aircraft Braking Systems Corporation assumes no responsibility for wheel failures caused by poor/incorrect or infrequent overhaul procedures that result in property loss/damage and/or personal injury.

**C. OVERHAUL PROCEDURES:**

- (1) The Component Maintenance Manual is written to give step by step procedures to overhaul the wheel assembly. The CMM is divided into sections which include: TESTING AND FAULT ISOLATION, DISASSEMBLY, CLEANING, CHECK, REPAIR and ASSEMBLY AND STORAGE. These sections must be followed in the order given in the CMM to correctly overhaul the wheel assembly. The CMM also includes sections with information on the wheel assembly and the equipment needed to assemble the wheel. These sections include: DESCRIPTION AND OPERATION, FITS AND CLEARANCES, SPECIAL TOOLS, FIXTURES AND EQUIPMENT and ILLUSTRATED PARTS LIST.

**D. GENERAL UTILITY AIRCRAFT (GUA) (refer to Figure 1):**

**NOTE:** The guidelines that follow are for general utility aircraft and assume a tire life of 150 landings with 4 roll miles (6,4 km) for each take-off and landing cycle. If the 4 roll miles (6,4 km) and/or a tire life of 150 landings are not good assumptions for an operator, the maintenance schedule can be increased or decreased as necessary.

- (1) General utility aircraft are typically aircraft with a maximum gross take-off weight (MGTO) less than 12,500 pounds (5670 kg).
- (2) Make a visual inspection of each wheel half at each tire change as told in the appropriate CMM. Also, it is recommended that an eddy current inspection or an ultrasonic inspection of the bead seat area be done at each tire change.

**NOTE:** An eddy current inspection or an ultrasonic inspection must be done at each wheel overhaul.

- (3) Do an overhaul to the wheel assembly at the 4th, 8th, 11th, 14th and 17th tire change. Do an overhaul to the wheel assembly at each tire change after the 17th tire change.
- (4) If there are indications of defects when steps (2) and (3) are done, the wheel assembly must be fully overhauled as told in the appropriate CMM before it is used again. The wheel assembly must also be overhauled at each consecutive tire change. If the defect is a crack in the wheel half, the wheel half must be removed from service.

TIRE CHANGE NUMBER	EXAMINATION PROCEDURE		
	VISUAL EXAM	EDDY CURRENT OR ULTRASONIC INSPECTION	OVERHAUL
1	X		
2	X		
3	X		
4	X	X	X
5	X		
6	X		
7	X		
8	X	X	X
9	X		
10	X		
11	X	X	X
12	X		
13	X		

TIRE CHANGE NUMBER	EXAMINATION PROCEDURE		
	VISUAL EXAM	EDDY CURRENT OR ULTRASONIC INSPECTION	OVERHAUL
14	X	X	X
15	X		
16	X		
17	X	X	X
18	X	X	X
19	X	X	X
20	X	X	X
21	X	X	X
22	X	X	X
23	X	X	X
24	X	X	X
25	X	X	X
26	X	X	X

Inspection and Overhaul Increments for General Utility Aircraft  
Figure 1

E. COMMUTER AND BUSINESS JET TYPE AIRCRAFT (refer to Figure 2):

**NOTE:** The guidelines that follow are for commuter and business jet type aircraft only and assume a tire life of 225 landings with 4.5 roll miles (7,2 km) for each take-off and landing cycle. If the 4.5 roll miles (7,2 km) and/or a tire life of 225 landings are not good assumptions for an operator, the maintenance schedule can be increased or decreased as necessary.

- (1) Commuter and business jet type aircraft are typically aircraft with a maximum gross take-off weight (MGTO) between 12500 and 78000 pounds (5670 and 35380 kg).
- (2) Make a visual inspection of each wheel half at each tire change as told in the appropriate CMM. Also, it is recommended that an eddy current inspection or an ultrasonic inspection of the bead seat area be done at each tire change.

**NOTE:** An eddy current inspection or an ultrasonic inspection must be done at each wheel overhaul.

- (3) Do an overhaul to the wheel assembly at the 5th, 10th, 13th, 16th and 19th tire change. Do an overhaul to the wheel assembly at each tire change after the 19th tire change.
- (4) If there are indications of defects when steps (2) and (3) are done, the wheel assembly must be fully overhauled as told in the appropriate CMM before it is used again. The wheel assembly must also be overhauled at each consecutive tire change. If the defect is a crack in the wheel half, the wheel half must be removed from service.

TIRE CHANGE NUMBER	EXAMINATION PROCEDURE		
	VISUAL EXAM	EDDY CURRENT OR ULTRASONIC INSPECTION	OVERHAUL
1	X		
2	X		
3	X		
4	X		
5	X	X	X
6	X		
7	X		
8	X		
9	X		
10	X	X	X
11	X		
12	X		
13	X	X	X

TIRE CHANGE NUMBER	EXAMINATION PROCEDURE		
	VISUAL EXAM	EDDY CURRENT OR ULTRA SONIC INSPECTION	OVERHAUL
14	X		
15	X		
16	X	X	X
17	X		
18	X		
19	X	X	X
20	X	X	X
21	X	X	X
22	X	X	X
23	X	X	X
24	X	X	X
25	X	X	X
26	X	X	X

Inspection and Overhaul Increments for Commuter and Business Jet Type Aircraft  
Figure 2

F. COMMERCIAL JET TYPE AIRCRAFT (refer to Figure 3):

**NOTE:** The guidelines that follow are for commercial jet type aircraft only and assume a tire life of 350 landings with 5 roll miles (8,0 km) for each take-off and landing cycle. If the 5 roll miles (8,0 km) and/or a tire life of 350 landings are not good assumptions for an operator, the maintenance schedule can be increased or decreased as necessary.

- (1) Commercial jet type aircraft are typically aircraft with a maximum gross take-off weight (MGTOW) more than 78000 pounds (35380 kg).
- (2) Make a visual inspection of each wheel half at each tire change as told in the appropriate CMM. Also, it is recommended that an eddy current inspection or an ultrasonic inspection of the bead seat area be done at each tire change.

**NOTE:** An eddy current inspection or an ultrasonic inspection must be done at each wheel overhaul.

- (3) Do an overhaul to the wheel assembly at the 5th, 10th, 15th, 18th, 21st, 24th, 27th and 30th tire change. Do an overhaul to the wheel assembly at each tire change after the 30th tire change.
- (4) If there are indications of defects when steps (2) and (3) are done, the wheel assembly must be fully overhauled as told in the appropriate CMM before it is used again. The wheel assembly must also be overhauled at each consecutive tire change. If the defect is a crack in the wheel half, the wheel half must be removed from service.

TIRE CHANGE NUMBER	EXAMINATION PROCEDURE		
	VISUAL EXAM	EDDY CURRENT OR ULTRASONIC INSPECTION	OVERHAUL
1	X		
2	X		
3	X		
4	X		
5	X	X	X
6	X		
7	X		
8	X		
9	X		
10	X	X	X
11	X		
12	X		
13	X		
14	X		
15	X	X	X
16	X		
17	X		

TIRE CHANGE NUMBER	EXAMINATION PROCEDURE		
	VISUAL EXAM	EDDY CURRENT OR ULTRASONIC INSPECTION	OVERHAUL
18	X	X	X
19	X		
20	X		
21	X	X	X
22	X		
23	X		
24	X	X	X
25	X		
26	X		
27	X	X	X
28	X		
29	X		
30	X	X	X
31	X	X	X
32	X	X	X
33	X	X	X
34	X	X	X

Inspection and Overhaul Increments for Commercial Jet Type Aircraft  
Figure 3

G. COMMERCIAL ROTARY WING AIRCRAFT (refer to Figure 4):

**NOTE:** The guidelines that follow are for commercial rotary wing aircraft only and assume a tire life of 100 landings with 2.5 roll miles (4,0 km) for each take-off and landing cycle. If the 2.5 roll miles (4,0 km) and/or a tire life of 100 landings are not good assumptions for an operator, the maintenance schedule can be increased or decreased as necessary.

- (1) Commercial rotary wing aircraft include all types of helicopters.
- (2) Make a visual inspection of each wheel half at each tire change as told in the appropriate CMM. Also do an eddy current inspection or an ultrasonic inspection of the bead seat area at each tire change.
- (3) Do an overhaul to the wheel assembly at the 2nd, 4th and 6th tire change. Do an overhaul to the wheel assembly at each tire change after the 6th tire change.
- (4) If there are indications of defects when steps (2) and (3) are done, the wheel assembly must be fully overhauled as told in the appropriate CMM before it is used again. The wheel assembly must also be overhauled at each consecutive tire change. If the defect is a crack in the wheel half, the wheel half must be removed from service.

TIRE CHANGE NUMBER	EXAMINATION PROCEDURE		
	VISUAL EXAM	EDDY CURRENT OR ULTRASONIC INSPECTION	OVERHAUL
1	X	X	
2	X	X	X
3	X	X	
4	X	X	X
5	X	X	
6	X	X	X
7	X	X	X
8	X	X	X
9	X	X	X
10	X	X	X
11	X	X	X
12	X	X	X
13	X	X	X

Inspection and Overhaul Increments for Commercial Rotary Wing Aircraft  
Figure 4

**SECTION III – MATERIAL INFORMATION**

- A. Not applicable.

# 1124-WESTWIND

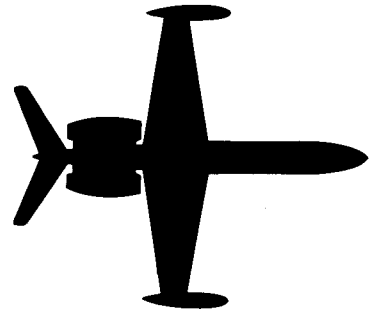

## SERVICE INFORMATION LETTER

---

SIL NO. 1124-32-022

March 20, 1985

SUBJECT: STEERING YOKE - GREASE FITTING REPLACEMENT

EFFECTIVITY: MODEL 1124/24A WESTWIND aircraft, serial numbers 354-359, 361 and subsequent.

A. REASON

To eliminate interference between the steering yoke grease fitting and the upper body (58° steering only).

B. REFERENCES

1124/24A Illustrated Parts Catalog Chapter 32-50-00, Figure 7, Item 31.

C. PUBLICATIONS AFFECTED

1124/1124A Illustrated Parts Catalog Chapter 32-50-00 will be revised to reflect the modification described.

D. DESCRIPTION

Several aircraft equipped with 58° steering have experienced damage to the grease fitting installed in the aft side of the P/N ES12971-501 yoke because of interference with the upper body.

This problem can be corrected by replacing the MS15001-1 grease fitting with P/N 2236-0000-003. Install with Locktite Compound 35 or equivalent.

Available from Atlantic Aviation Supply Co., Wilmington, DE at no charge.



SUBSIDIARY OF ISRAEL AIRCRAFT INDUSTRIES, LTD.  
BEN GURION AIRPORT, ISRAEL

SIL 1124-32-022  
Page 1 of 1

# 1124-WESTWIND

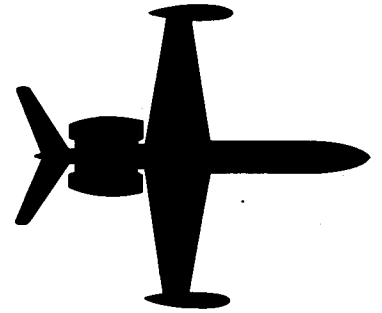

## SERVICE INFORMATION LETTER

---

SIL NO. 1124-32-033

March 20, 1985

SUBJECT: MAIN/NOSE LANDING GEAR - REVISED LIMIT SWITCH  
ADJUSTMENTS

EFFECTIVITY: MODEL 1124/1124A WESTWIND, all serial numbers.

A. REASON

To revise the landing gear limit switch adjustment for all 1124/1124A Westwind main landing gear downlock switches, main landing gear ground contact switches and the nose landing gear ground contact switch.

B. REFERENCES

1124/1124A Maintenance Manual, Chapter 32.

C. PUBLICATIONS AFFECTED

The information contained in this SIL will be included in the next scheduled revision to Chapter 32 of the 1124/1124A Maintenance Manual.

D. DESCRIPTION

1. Main Landing Gear Down Lock Switch Adjustment. The 1124/1124A Maintenance Manual, Chapter 32-60-00, page 201, paragraph A (8) should read:
  - (a) Continue  $1 \frac{1}{2}$  turns more instead of Continue  $\frac{1}{2}$  turns.
2. Nose Landing Gear Ground Contact Switch. The 1124/1124A Maintenance Manual, Chapter 32-60-00, page 203, paragraph C (l) (e), (k), (note) should read:



SUBSIDIARY OF ISRAEL AIRCRAFT INDUSTRIES, LTD.  
BEN GURION AIRPORT, ISRAEL

SIL 1124-32-033  
Page 1 of 2

- (a) Change C (1) (e) from "Make a reference mark on the piston at a point 0.1 inch from bottom of inner strut body " to "At a point 1.0 inch from bottom of inner strut body."
  - (b) Change C (1) (k) from "Retain a bent knee of at least .005" when strut is fully extended" to "Retain a bent knee of at least  $10^{\circ}$  when strut is fully extended."
  - (c) Change NOTE to CAUTION: "Retain a minimum of  $10^{\circ}$  angle from switch pivot point centerline to eliminate possibility of arms going into geometrical lock over-center when strut is fully extended."
3. Main Landing Gear Ground Contact Switch Adjustment.
- (a) Insert the following between paragraphs (h) and (i):

CAUTION

Maintain a minimum of  $10^{\circ}$  angle from switch arm pivot point centerline to eliminate possibility of arms going into geometrical lock overcenter when strut is fully extended.



# 1124-WESTWIND

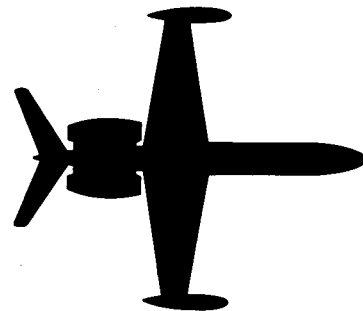

## SERVICE INFORMATION LETTER

---

---

SIL NO. 1124-32-041

April 2, 1985

SUBJECT: GOODYEAR NOSE GEAR BEARING SEALS

EFFECTIVITY: MODEL 1124/1124A WESTWIND, all serial numbers.

A. REASON

To announce the availability of an improved Goodyear Nose Wheel Bearing Seal.

B. REFERENCES

1124/1124A IPC, 32-20-00, Page 5.

C. PUBLICATIONS AFFECTED

1124/1124A IPC, 32-20-00, Page 5.

D. DESCRIPTION

The Goodyear P/N 9532409 nose wheel bearing seal has been replaced by the Goodyear P/N 9524218 seal.

Installation of the P/N 9524218 nose wheel bearing seals varies from the installation of the P/N 9532409 seals as follows:

The P/N 9532409 seals were installed into the nose wheel halves and rotated with the wheel. Their sealing surfaces were the inner diameter surfaces against the stationary wheel spacers.

The P/N 9524218 seals are installed between the bearings and spacers. The seals remain stationary with the nut, washer, and spacer. Sealing action takes place at its outer perimeter face on the rotating bearing cup.



SUBSIDIARY OF ISRAEL AIRCRAFT INDUSTRIES, LTD.  
BEN GURION AIRPORT, ISRAEL

SIL 1124-32-041  
Page 1 of 2

SERVICE INFORMATION LETTER NO. 1124-32-041

Installation of the nose wheel assembly remains essentially the same. Torque of the nose wheel retainer nut is as follows:

1. Tighten nut to 120 inch-pounds while rotating wheel.
2. Loosen nut to zero torque.
3. Torque to minimum 20 inch-pounds continuing to location of next safety hole castellation, if necessary.
4. Bearing seals and spacers shall be stationary in relation to rotating wheel after torque is applied.

END

# 1124-WESTWIND

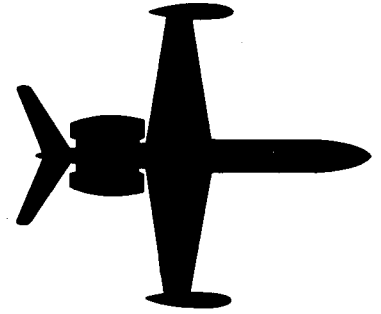

## SERVICE INFORMATION LETTER

SERVICE INFORMATION LETTER NO. 1124-32-098

August 12, 1992

**SUBJECT:** LANDING GEAR - NOSE WHEEL BOLT HOLE REPAIR

**EFFECTIVITY:** MODEL 1124/1124A WESTWIND, all serial numbers.

**A. REASON**

Corrosion has been found in nose wheel bolt holes that exceeds the limits in the component maintenance manual.

**B. REFERENCE**

Aircraft Braking Systems Manual, No. AP-507, Revision No. 3.

**C. PUBLICATIONS AFFECTED**

None.

**D. DESCRIPTION**

Aircraft Braking Systems Corporation has issued Revision No. 3 to holders of AP-507 Component Maintenance Manual for Nose Wheel Assembly P/N 9541874. This revision adds a wheel bolt hole bushing repair for repair of nose wheels with corrosion beyond specified limits.

Aircraft Braking Systems Corporation publications may be ordered from:

Aircraft Braking Systems Corporation  
Publications Department 648  
1204 Massillon Road  
Akron, OH 44306-4186  
Phone: 216-796-8081  
Fax: 216-796-9805

# 1124-WESTWIND

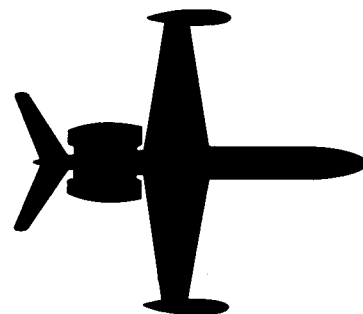

## SERVICE INFORMATION LETTER

---

---

SIL NO. 1124-33-008

December 18, 1984

SUBJECT: STACO SWITCH AND LAMP ASSEMBLIES.

EFFECTIVITY: MODEL 1124/1124A, all serial numbers

A. REASON

To provide installation/removal instructions for the push-button-body assembly.

B. REFERENCES

MODEL 1124 Maintenance Manual, Chapter 33-10-00.

C. PUBLICATIONS AFFECTED

MODEL 1124 Maintenance Manual, Chapter 33-10-00 will be revised to reflect these removal/installation procedures.

D. DESCRIPTION

This SIL provides maintenance personnel with detailed instructions on techniques utilized in switch and lamp assembly replacements.

SIL 1124-33-008  
Page 1 of 7



SUBSIDIARY OF ISRAEL AIRCRAFT INDUSTRIES, LTD.  
BEN GURION AIRPORT, ISRAEL

E. REMOVAL INSTRUCTIONS

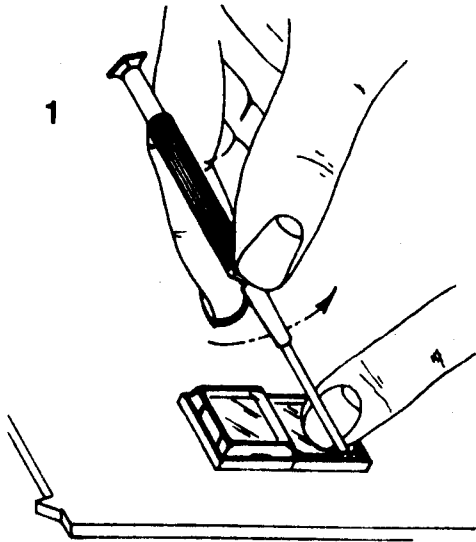

1. Depress pushbutton until latch lever is free to move. Using small screwdriver or fingernail, push latch lever to right and hold.

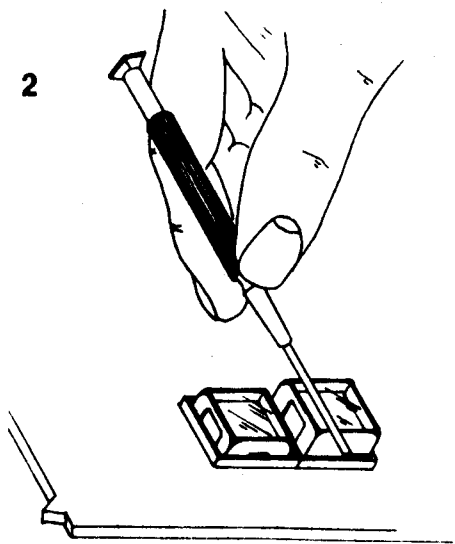

2. While holding latch lever to right, release pushbutton. Spring loaded lamp contacts will push pushbutton to an extended position above the switch/indicator housing.

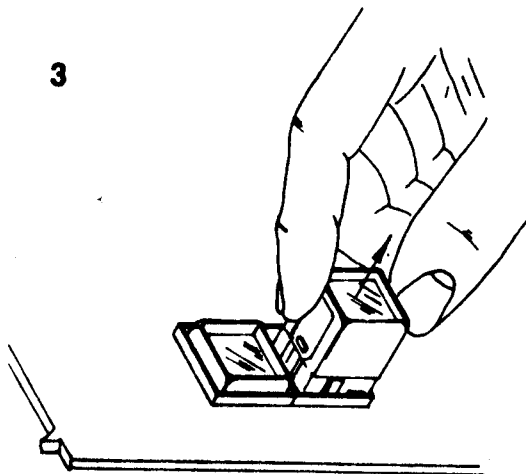

3. Release latch lever and pull pushbutton from the housing.

## F. INSTALLATION INSTRUCTIONS

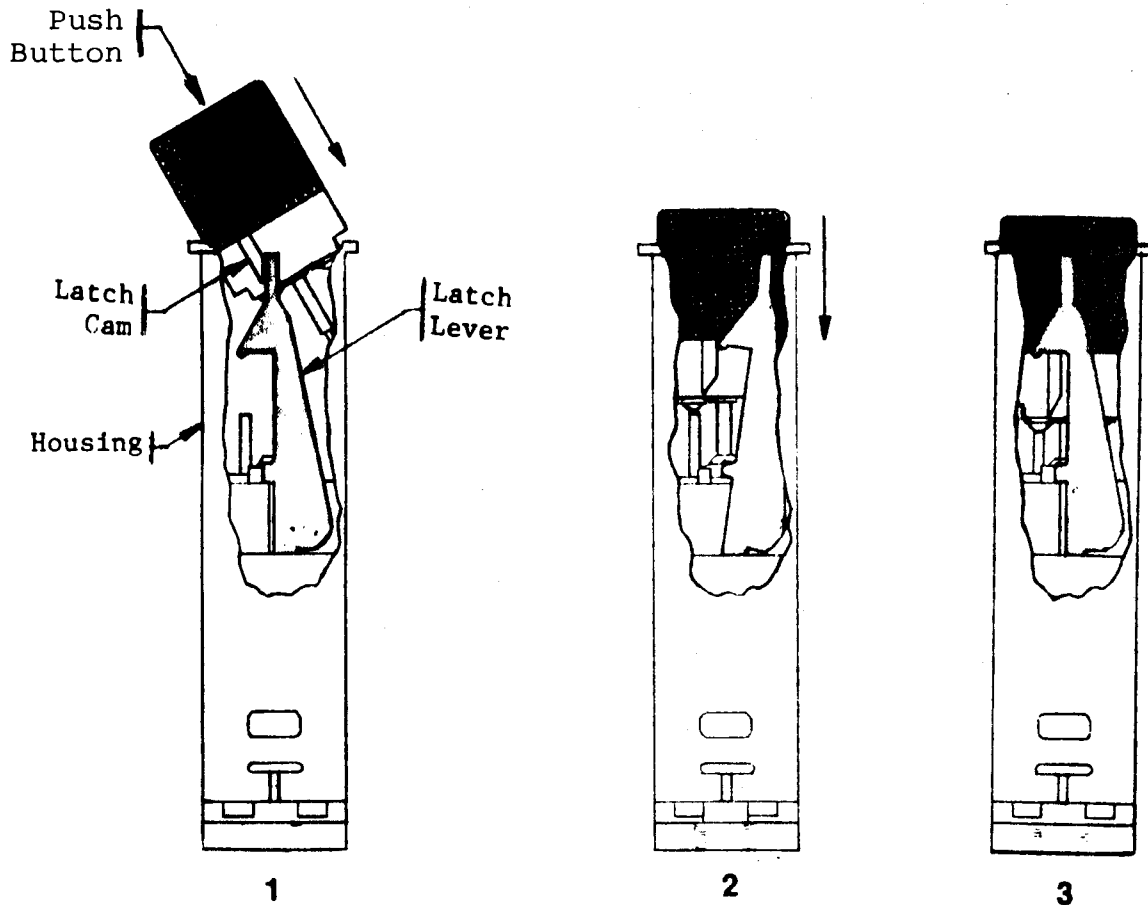

1. Position pushbutton so bottom of legend faces latch lever. This places cam on the pushbutton in position to engage the latch lever. Tilt the pushbutton so that angle on the cam will push the latch lever to the right as the pushbutton is advanced into the housing toward the switch/indicator module.
2. The pushbutton is advanced downward into the housing, and at the same time straightened up to index into the switch/indicator module. This will allow the latch lever to ride on the side of the cam, moving it outward.
3. As the pushbutton is pushed downward into the engaged position, the latch lever will move over the top of the cam, locking onto the cam. This engagement of the latch lever will retain the pushbutton in the switch/indicator housing, while allowing for additional downward movement for switch actuation.

CAUTION: Do not force pushbutton into housing without allowing the cam to move the latch lever into the proper locking position. Forcing the pushbutton may trap the latch lever between the cam and the housing causing the pushbutton to jam and be nonoperative. INSTALL LAMPS IN PUSHBUTTON BEFORE INSERTING IN HOUSING. THIS IS IMPORTANT FOR EASY REMOVAL OF PUSHBUTTON.

G. Switch Body Removal and Installation

NOTE

It is recommended that the panel in which the defective switch is mounted be removed to improve accessibility and prevent damage to surrounding areas.

- (1) Refer to the appropriate wiring diagram. Identify wire and switch pin numbers.
- (2) Cut wire ties and separate wire bundles. Unsolder each pin and tag each wire.
- (3) Remove screw from rear of switch body and push switch assembly through front of holder.
- (4) Reassembly is reverse of above steps.

H. Part Number Identification:

- (1) All lamp and pushbutton assemblies carry the IAI part number 883743-XX, where the -XX identifies the switch use and engraved legend. This 883743 number can be crossed to the basic STACO part number 44XXXX, 45XXXX, or 46XXXX, by reference to Figure 1 and/or Figure 2.
- (2) The STACO dash number identifying the switch use and legend may be found stamped on the plastic lens assembly body; and, by looking inside switch body, stamped on the lamp base contactor plate.

(3) In the event of damage or failure of lens and/or switch assembly, and the entire part number with proper dash number cannot be obtained; you may order any other Lens/Switch assembly (it must be both) with a different dash number. Check to be sure it will have enough switch contacts.

(a) Refer to sketch (below), rewire switch assembly and change the lens assembly legend plate and/or color inserts as necessary.

(b) Note in your IPC or Wiring Diagram the change of switch part number

**TYPICAL PUSHBUTTON ASSEMBLY**

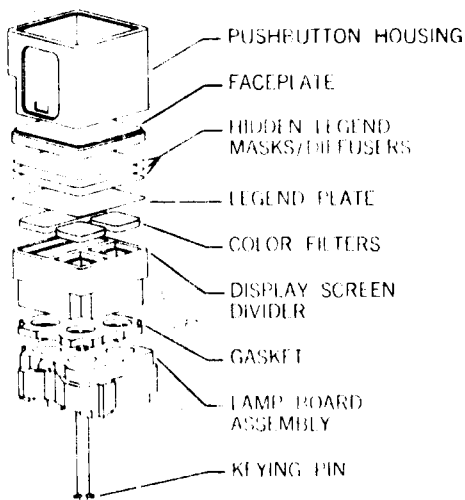

**SPLIT LAMP GROUND**

Pushbutton available with either common lamp ground or split lamp ground with lamps 1 and 4 on one ground and lamps 2 and 3 on the other ground. For vertical 2-way split the switch/indicator is installed with the latch lever at the bottom. For a horizontal 2-way split the switch/indicator is positioned so that the latch lever is at the left, as shown above.

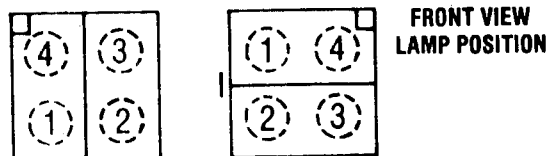

Ref. Latch lever position when switch/indicator installed.

I. A repair kit for these switches with interchangeable parts, is available from:

STACO Switch, Inc  
 1139 Baker St.  
 Costa Mesa, CA 92626  
 714-549-3041



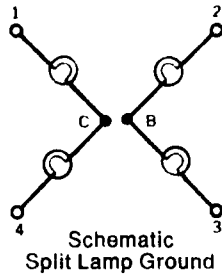
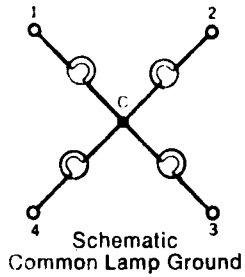

MODEL 41 & 43  
FLUSH BUTTON

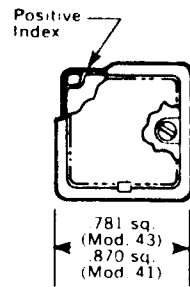

MODEL 42 AND 44  
EXTENDED BUTTONS

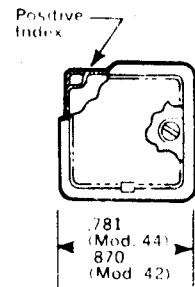

TYPICAL PART NUMBER FOR SWITCH ASSEMBLY

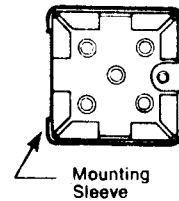
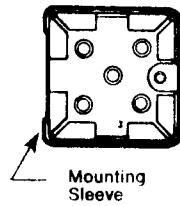
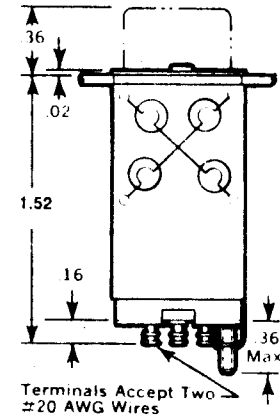
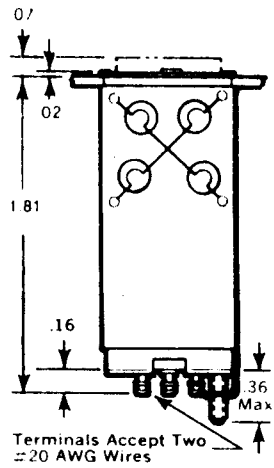
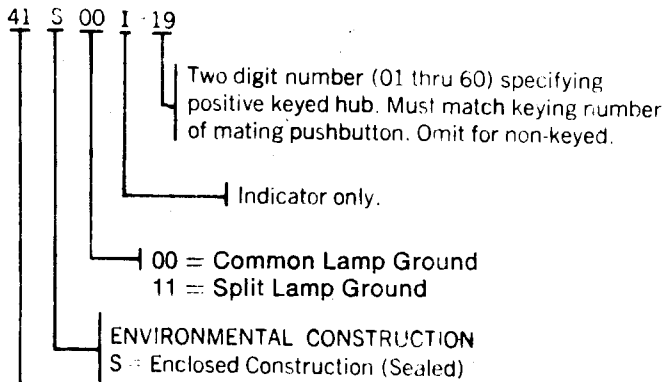

MODEL	PUSHBUTTON	MOUNTING CENTERS
44	Extended	.814 min.

FIGURE 1  
ANNUNCIATOR LAMP ASSY

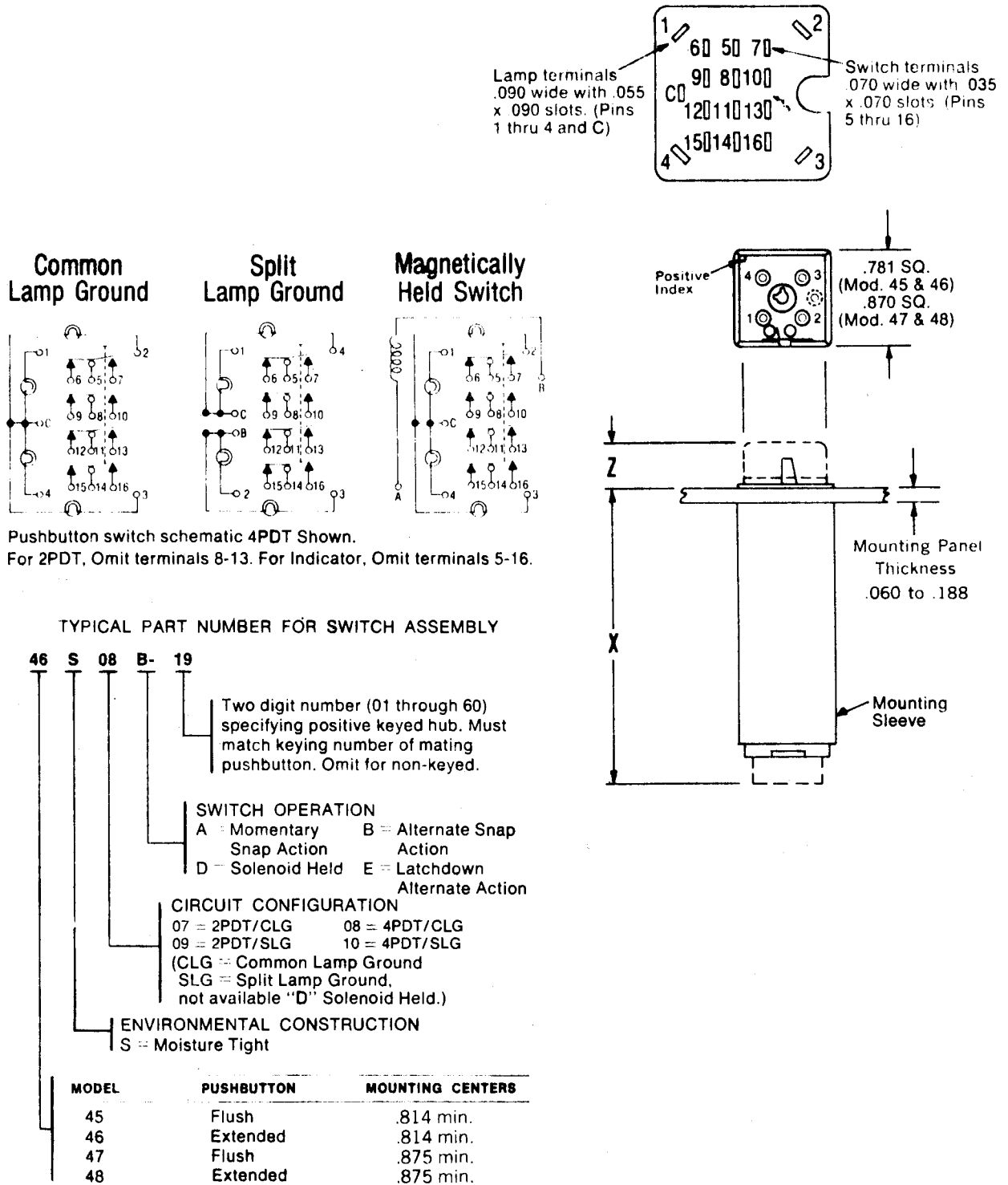

FIGURE 2  
ANNUNCIATOR AND SWITCH ASSEMBLIES

# SERVICE PUBLICATIONS

# revision notice

---

SIL NO. 1124-33-025  
Revision No. 1

September 9, 1985

SUBJECT: FAILURE OF AIRCRAFT SYSTEM AND LAMP TEST FUNCTIONS.

EFFECTIVITY: MODEL 1124 WESTWINDS, all serial numbers.

REASON FOR  
REVISION:

To advise operators that diode P/N 1N3613  
is also approved as a replacement for the  
original P/N 1N645 diodes in the annunciator  
panel modules.

SIL 1124-33-025  
Page 1 of 1



INTERNATIONAL INC.  
ISRAEL AIRCRAFT INDUSTRIES INTERNATIONAL INC

SUBSIDIARY OF ISRAEL AIRCRAFT INDUSTRIES. LTD  
BEN GURION AIRPORT, ISRAEL

# 1124-WESTWIND

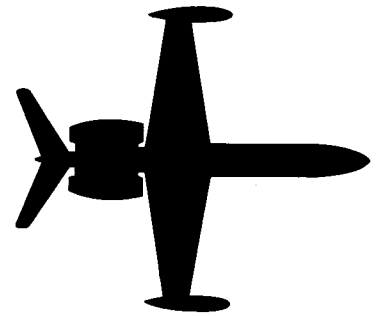

## SERVICE INFORMATION LETTER

---

---

SIL NO. 1124-33-025

March 11, 1985

SUBJECT: FAILURE OF AIRCRAFT SYSTEM AND LAMP TEST FUNCTIONS.

EFFECTIVITY: MODEL 1124 WESTWINDS, all serial numbers.

A. REASON

To prevent improper aircraft system operation and/or test caused by isolation diode breakdown.

B. REFERENCES

1124 Aircraft Maintenance Manual, Chapter 33.

D. DESCRIPTION

- (1) When performing normal preflight or postflight system tests, be alert for indications of false current paths created by open or shorted isolation diodes.
- (2) Such indications may be inadvertent operation of an aircraft system unrelated to that under test, the system annunciators fail to illuminate or are very dim, the wrong annunciators operate or operate dimly or a malfunction of the system under test may occur.
- (3) The majority of these system test failures are caused by the isolation diode P/N 1N645 failing due to excessive current flow (such as a shorted lamp bulb) or by voltage spikes exceeding the diode rating. These diodes are used in the various Annunciator Lamp modules, the plug-in circuit cards (P/N 833513-X) located forward of the instrument panel and in the various relay and contactor boxes, and on post-type terminal boards in the same areas.

- (4) To provide adequate protection, replace any suspect P/N 1N645 diodes with P/N 1N4005 (1 AMP, 600 PIV) or equivalent.
  - (a) To replace diodes mounted on lamp modules or circuit boards, remove the varnish with MEK, unsolder the diode (use Solder-wick to prevent delaminating the circuit and to remove solder from the holes). Avoid excess heat.
  - (b) To use the 1N4005 diode, enlarge the original diode wire lead holes to .035 inch (#65 drill), insert new diode ensuring proper polarity, and solder in place. Use a heat-sink to prevent component damage, and do not bend wire at new diode case. Form the lead at a 90° angle using long nose pliers. Lead bends to be of equal length from diode case, length to be determined by hole spacing.
  - (c) Recoat work area with a silicone printed circuit varnish, or "post coat" such as Humi-Seal.

# **1124-WESTWIND**

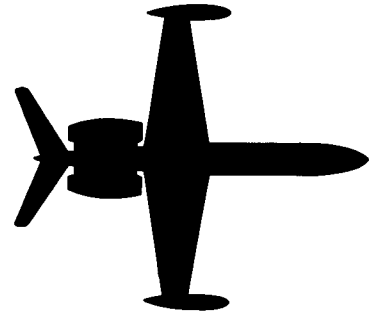

## **SERVICE INFORMATION LETTER**

---

---

SERVICE INFORMATION LETTER NO. 1124-33-032

JULY 8, 1988

**SUBJECT: LIGHTING - COCKPIT GLARESHIELD - FLOODLIGHT  
IMPROVEMENT.**

**EFFECTIVITY: MODEL 1124/1124A WESTWIND, all serial numbers.**

**A. REASON**

To alert 1124/1124A operators that a Service Bulletin has been published by Aerospace Lighting Corporation against their fluorescent lamps with certain part numbers. Due to the possibility of higher than normal temperatures at the lamp ends caused by filament degradation, the manufacturer has recommended a modification to the lamp ends to reduce the heat stress.

**B. REFERENCES**

Attached Aerospace Lighting Corporation Service Bulletin No. ALC-SB-004 issued 23 Dec 87.

**C. PUBLICATIONS AFFECTED**

1124/1124A Maintenance Manual Chapter 33-10-00, Maintenance Practices.



SUBSIDIARY OF ISRAEL AIRCRAFT INDUSTRIES, LTD.  
BEN GURION AIRPORT, ISRAEL

SIL 1124-33-032  
Page 1 of 2

D. DESCRIPTION

The additional heat that may be generated may cause lamp-end cracks which will expose the lamp filaments. The addition of the Teflon Shrink Tubing to the lamp ends will aid in the distribution of heat and prevent shattering.

All flood lamp assemblies delivered by ALC after Dec 87 will have the retro-fit incorporated during manufacture according to Aerospace Lighting Corporation.

# SERVICE BULLETIN

---

NUMBER: ALC-SB-004      ISSUE DATE: 23 DEC 87      REVISION DATE: N/R

APPLICABILITY:

All cockpit fluorescent floodlight assemblies manufactured by Aerospace Lighting Corporation bearing the Part Numbers listed in Attachment A.

IDENTIFICATION: (See Figures A1, A2)

Floodlight assemblies which have been retro-fitted will be identified by a blue dot paint marking located in the white space next to the serial number (See Figure A2). A second dot will be located on the face of the bucket assembly (See Figure A1) to allow identification without removing the floodlight assembly from the aircraft. New floodlight assemblies which have the retro-fit incorporated at manufacturing will also be marked with a blue paint dot in both designated areas.

SUBJECT:

Retro-fit teflon shrink tubing to the ends of the fluorescent lamps in the listed floodlight assemblies to prevent exposing the filaments in the event of lamp failure.

COMPLIANCE:

1. Optional/Recommended in field
2. Mandatory by ALC Repair Station for assemblies sent to ALC for testing/repair.

DISCUSSION:

Extensive laboratory and field testing has indicated that fluorescent lamps which have high operating time and/or filament degradation may produce higher than normal temperatures at the lamp ends. The additional heat stress may cause the lamps to crack near the end thereby exposing the lamp filament. The addition of teflon shrink tubing to the lamp end will aid in distribution of the heat along the lamp, thereby reducing the heat stress. Further, if the lamp should fail, the teflon shrink tubing will prevent shattering and exposure of the lamp filaments.



**CLASSIFICATION:**

The retro-fit does not affect form, fit or function and is therefore classified as minor in nature.

**WEIGHT AND BALANCE:**

Negligible - less than 0.1 ounces.

**TIME AND MATERIALS:**

Estimated time to complete the retro-fit procedure is approximately 30 minutes. This does not include access/removal/installation time on the aircraft.

**DESCRIPTION OF MATERIAL AND TOOLS REQUIRED:**

1. FEP teflon shrink tubing equivalent to  
ALPHA WIRE CORPORATION P/N FIT-400-4  
711 Lidgerwood Avenue/P.O. BOX 711  
Elizabeth, New Jersey 07207 (201) 925-8000
2. Kester "44" Resin Core Solder SN60 or equivalent.
3. Insulating varnish equivalent to "Red GLPT  
Insulating Varnish", manufactured by GC Electronic,  
Rockford, IL 61105; (815) 968-4661. P/N 10-9002.
4. General purpose heatgun to deliver 176°C and common  
electronic repair hand tools.

**INSTRUCTIONS:**

Complete retro-fit instructions and illustrations are included in Attachment B.

**FOR FURTHER INFORMATION:**

AEROSPACE LIGHTING CORPORATION  
101-8 Colin Drive  
Holbrook, New York 11741  
(516)563-6400  
Telex: 64-5135  
Fax: (516)563-8781

# FIGURE A-1

TYPICAL VIEW -  
ONE END OF 6 mm  
LAMP ASSEMBLY

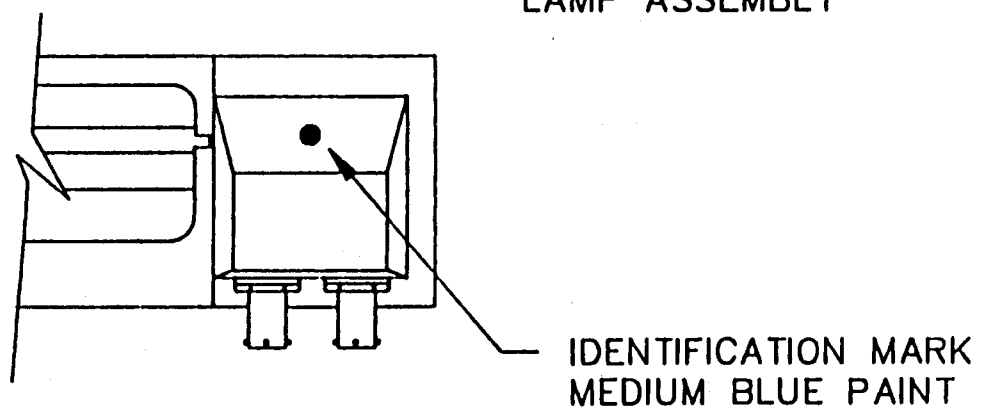

# FIGURE A-2

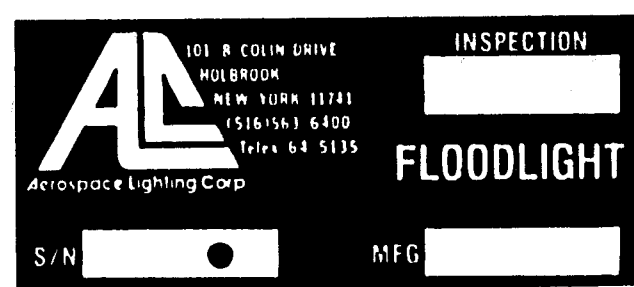

IDENTIFICATION MARK  
MEDIUM BLUE PAINT

**ATTACHMENT A**

**Floodlights**

<u>Floodlight</u> <u>Part Number</u>	<u>Designed for use on</u> <u>Aircraft</u>	<u>Manufactured by</u>
10-20P22-501	HS-125-700	British Aerospace
10-20S22-501	HS-125-700	British Aerospace
10-21C22-501	HS-125-700	British Aerospace
10-21C22-503	Various	Gulfstream Aerospace
10-21C22-511	SF-340	Saab Scania
10-21C22-512	Various	British Aerospace
10-21C22-513	EMB-120	Embraer Aircraft
10-21P22-502	HU-25A	Falcon Jet Corporation
10-21P22-503	Various	Gulfstream Aerospace
10-21P22-504	S-76	Sikorsky Aircraft
10-21P22-505	PA-42	Piper Aircraft
10-21P22-508	Various	Gulfstream Aerospace
10-21P22-511	SF-340	Saab Scania
10-21P22-512	Various	British Aerospace
10-21P22-513	EMB-120	Embraer Aircraft
10-21PS22-503	Various	Gulfstream Aerospace
10-21S22-502	HU-25A	Falcon Jet Corporation
10-21S22-503	Various	Gulfstream Aerospace
10-21S22-504	S-76	Sikorsky Aircraft
10-21S22-505	PA-42	Piper Aircraft
10-21S22-508	Various	Gulfstream Aerospace
10-21S22-511	SF-340	Saab Scania
10-21S22-512	Various	British Aerospace
10-21S22-513	EMB-120	Embraer Aircraft
10-701-2L-8.00B	Various	Israel Aircraft Industries
10-701-2L-10.00B	Various	Israel Aircraft Industries
10-701-2L-14.00C	Various	Gulfstream Aerospace
10-701-2L/R-8.00B	Various	Israel Aircraft Industries
10-701-2L/R-10.00B	Various	Israel Aircraft Industries
10-701-2L/R-12.00B	Various	Israel Aircraft Industries
10-701-2L/R-14.00C	Various	Gulfstream Aerospace
10-701-2R-8.00B	Various	Israel Aircraft Industries
10-701-2R-14.00C	Various	Gulfstream Aerospace
10-701B-2LR-16.00	CL600/601	Canadair Limited
10-701B-C202L/R-24.00	NA265-65	Rockwell International
10-701C-2LR-15.00	CL600/601	Canadair Limited
10-701T-2LR-16.00	CL600/601	Canadair Limited
10-701T-C202L/R-24.00	NA265-65	Rockwell International
10-900VM-1L-20.00	Various	Gates Learjet
10-900VM2-1L-20.00	Various	Gates Learjet
10-901VM2-1L-20.00	Various	Gates Learjet

ATTACHMENT B

ALC-SB-004  
23 DEC 87

RETRO-FIT INSTRUCTIONS:

GENERAL:

- \* PREPARE A CLEAN, DRY AND PROPERLY EQUIPPED WORKSTATION BEFORE PROCEEDING WITH ANY WORK ON A FLOODLIGHT ASSEMBLY. FOLLOW STANDARD PRACTICES AND PROCEDURES FOR REMOVING AND REPLACING SOLDERED CONNECTIONS AND FOR USING COMMON HAND TOOLS.
- \* USE CAUTION TO AVOID OVERHEATING SOLDERED CONNECTIONS AS THIS MAY DAMAGE THE INSULATION OF THE CONNECTOR ASSEMBLY.
- \* OBSERVE STANDARD SHOP SAFETY PROCEDURES WHEN WORKING WITH SOLDERING IRONS, HEAT GUNS, SOLVENTS AND PAINTS.

INSPECTION: (SEE FIGURES A1, A2)

1. CHECK FOR A BLUE PAINT DOT IN THE WHITE SPACE NEXT TO THE SERIAL NUMBER OR ON THE FACE OF THE BUCKET ASSEMBLY OF THE FLOODLIGHT TO DETERMINE IF THE TEFLON SHRINK TUBING HAS ALREADY BEEN INSTALLED.

DISASSEMBLY INSTRUCTIONS:

2. DISASSEMBLE LAMP HOLDER FROM LAMP HOUSING BY LOOSENING SCREWS ALONG THE FACE OF THE LAMP HOLDER.

\*\*\* CAUTION \*\*\*

BE SURE TO NOTE ORIENTATION AND POSITION OF FILTER WALLS OR FILTER LENSES FOR PROPER RE-ASSEMBLY. BE SURE TO RETAIN THE GROUNDING WASHER BETWEEN THE LAMP HOUSING AND THE LAMP HOLDER FOR PROPER RE-ASSEMBLY.

3. REMOVE THE TWO LAMP CLAMPS WHICH SECURE THE FLUORESCENT LAMPS TO THE LAMP HOLDER.

4. UNSOLDER THE CONNECTIONS AT BOTH ENDS OF THE LAMP(S). REMOVE THE LAMP(S) FROM THE LAMP HOLDER.

\*\*\* CAUTION \*\*\*

BE SURE NOT TO DAMAGE OR LOSE THE HIGH VOLTAGE INSULATION SLEEVING ON THE LAMP LEAD WIRES FROM EACH LAMP END.

RETRO-FIT INSTRUCTIONS: (SEE FIGURE B)

5. PLACE THE NEW TEFLON SHRINK TUBING OVER EACH LAMP END TO EXTEND 3/4" IN FROM THE END OF THE PHOSPHOR COATING. USING A HEAT GUN, RATED FOR 176°C, SHRINK THE NEW TUBING TO FIT THE LAMP END.

**\*\*\* CAUTION \*\*\***

SHRINKING AT TOO HIGH A TEMPERATURE OR FOR TOO LONG WILL CAUSE THE SLEEVING TO DEFORM AND IMPEDE INSTALLATION.

RE-ASSEMBLY:

6. PLACE LAMP WITH THE NEW TEFLON SHRINK TUBING AND ORIGINAL HIGH VOLTAGE INSULATION SLEEVING INTO POSITION ON LAMP HOLDER AND GENTLY FORM THE LAMP LEADS AND SLEEVING. RE-SOLDER THE LAMP LEADS TO THE CONNECTOR ASSEMBLY AT EACH END. FOR TWO-LAMP FIXTURES SOLDER THE TWO INNER CONNECTIONS AT EACH END FIRST FOR EASE OF ASSEMBLY.

**\*\*\* CAUTION \*\*\***

MAKE SURE THAT THE HIGH VOLTAGE SLEEVING ON THE LAMP LEADS IS NOT DAMAGED, AND THAT LAMP LEADS ARE NOT EXPOSED.

7. COAT SOLDER CONNECTIONS WITH GLYPTL INSULATING VARNISH. ALLOW TO DRY FOR AT LEAST TEN MINUTES AND INSPECT THE COATING. IF THE FIRST COATING IS THIN OR DOES NOT COVER COMPLETELY REPEAT THE APPLICATION OF GLYPTL.

**\*\*\* CAUTION \*\*\***

BE SURE TO COMPLETELY COAT ALL EXPOSED SURFACES OF THE SOLDERED CONNECTIONS AND THE CONNECTOR TERMINAL.

8. REPLACE THE TWO LAMP CLAMPS WHICH SECURE THE LAMP(S) TO THE LAMP HOLDER ASSEMBLY AND USE GLYPTL TO COAT SCREW THREADS TO PREVENT LOOSENING.

9. RE-ASSEMBLE THE LAMP HOLDER TO THE LAMP HOUSING BY REPLACING THE SCREWS ALONG THE FACE OF THE LAMP HOLDER. IF THE FLOODLIGHT FIXTURE INCLUDES FILTER WALLS OR FILTER LENSES BE SURE TO REPLACE THESE IN THE PROPER ORIENTATION AND POSITION.

**\*\*\* CAUTION \*\*\***

BE CERTAIN THAT THE GROUNDING WASHER IS SANDWICHED BETWEEN THE LAMP HOLDER AND THE LAMP HOUSING, AND LOCATED AT THE ONE HOLE WHICH IS FREE OF PAINT.

MARKING: (SEE FIGURES A1, A2)

10. USE BLUE PAINT TO MARK AN IDENTIFYING DOT ON THE FACE OF THE BUCKET ASSEMBLY AND IN THE WHITE SPACE NEXT TO THE SERIAL NUMBER. THE BLUE DOTS INDICATE THAT INSULATION SLEEVING HAS BEEN RETROFITTED TO THE 6mm LAMPS.

FOR FURTHER INFORMATION:

AEROSPACE LIGHTING CORPORATION  
101-8 Colin Drive  
Holbrook, New York 11741  
(516)563-6400  
Telex: 64-5135  
Fax: (516)563-8781

FIGURE B

TYPICAL VIEW -  
ONE END OF 6 mm LAMP  
WITH INSULATION SLEEVING RETRO-FIT

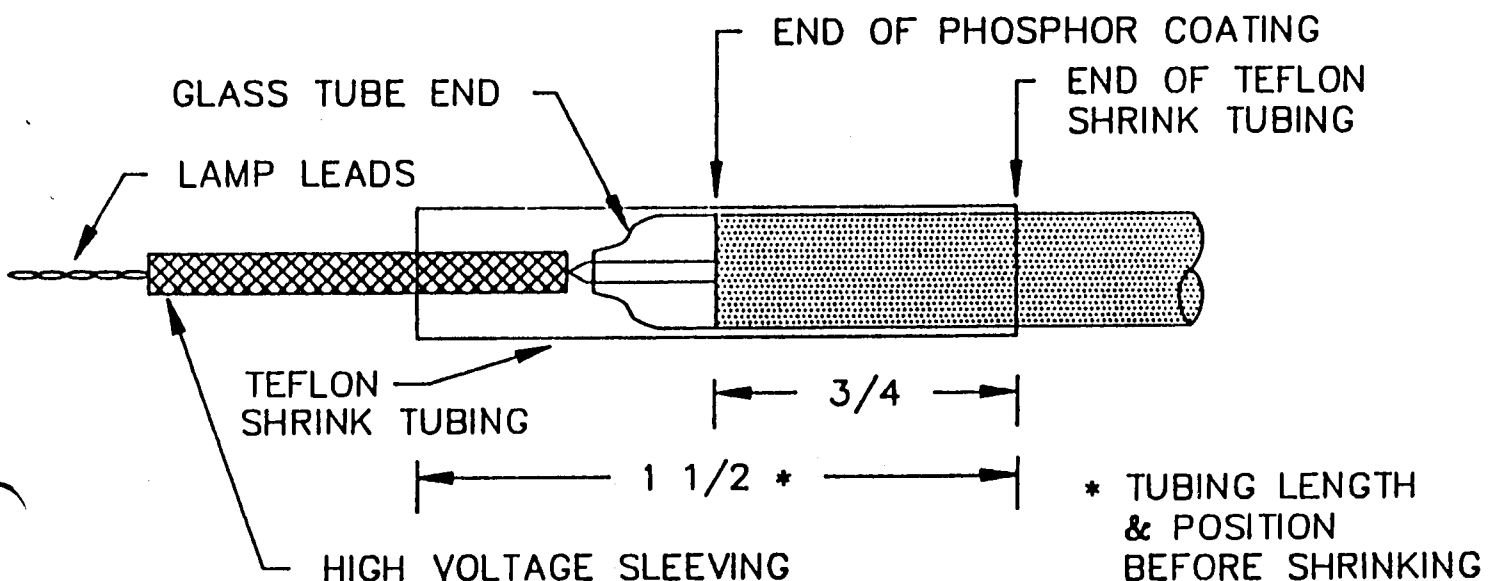

# 1124-WESTWIND

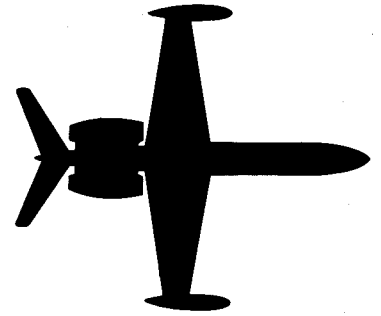

## SERVICE INFORMATION LETTER

---

---

SIL NO. 1124-33-058

September 27, 1985

SUBJECT: ELECTRICAL NOISE RADIATION FROM CABIN FLUORESCENT  
LIGHTING SYSTEM

EFFECTIVITY: MODEL 1124/1124A WESTWIND, all serial numbers

A. REASON

To eliminate noise from the cabin lighting system, especially when the preset "DIM" condition is selected. This noise is radiated into many aircraft systems, and has a severely adverse effect on VLF, ADF and HF receiver systems installed. The effect is to limit the receiver range, causing loss of navigation and/or errors at low system signal levels, or breaking the squelch and causing noisy communications reception.

B. REFERENCES

1124/1124A Wiring Diagram Manual, Chapter 33-20-02

1124/1124A Illustrated Parts Catalog, Chapter 33-20-00

C. PUBLICATIONS AFFECTED

None

D. DESCRIPTION

This service information letter contains troubleshooting information relevant to correcting the sources of the radiated noise.

SIL 1124-33-058  
Page 1 of 3



SUBSIDIARY OF ISRAEL AIRCRAFT INDUSTRIES, LTD.  
BEN GURION AIRPORT, ISRAEL

E. INSTRUCTIONS

1. Marginal, weak or defective lamp tubes may radiate directly into receiver systems, cause the associated lamp bank power supply to radiate, or both.
  - (a) For troubleshooting purposes, the lamps may be interchanged as long as the total length of all lamps connected to one bank transformer (TR-992, TR-991 or RPU-52) does not exceed 4 feet in length.

Part numbers for the various lamp lengths are as follows:

<u>Length</u>	<u>AeroSpace Lighting P/N</u>
12"	6635-320
19"	6635-490
24"	6635-610
48"	6635-1320

2. Improper voltage to the lamps may allow the system to think it has weak lamps, and radiate accordingly. The following readings are to be taken in "Bright" mode of operation.
  - (a) Output voltage from each inverter (18.996, 18.994, or PI-156-4) will average 190 volts AC, peak to peak (the preferred measurement), or approximately 130 volts AC, RMS.
  - (b) The output from each transformer to the lamp bank will average 340 volts AC, RMS.
3. A malfunctioning or misadjusted inverter can cause direct radiation, especially on the 28 Vdc input and dim control wiring.
  - (a) An inverter adjusted for too low a "DIM" output will create abnormal noise on the dim control wire. Repair and calibration by a vendor-certified repair station will be required.
4. In the event investigation of the above components does not resolve the noise, it is suggested the following be accomplished.
  - (a) Inspect wiring (reference WDM Chapter 33-20-02) for integrity. Ensure each inverter is driving the proper transformers, and that each transformer is driving only a single bank of lamps.



- (b) Those aircraft using the 18.996 and 18.994 inverters must ensure that the diode, P/N 1N645, is connected to pin C of each inverter as shown in the Wiring Diagram Manual.
5. AeroSpace Lighting Corporation (20 Oser Avenue, Hauppauge Long Island, New York 11787) has developed a filter, P/N LPF-1, expressly for eliminating the radiated noise from the inverter. The LPF-1 is designed to mount near and connect to the inverter input and dim control wiring. You may contact them at the above address or telephone (516) 234-1060 for further details.

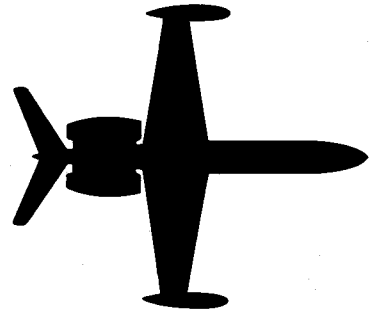

# SERVICE INFORMATION LETTER

---

---

SERVICE INFORMATION LETTER NO. 1124-33-084

December 12, 1990

**SUBJECT:** LIGHTING - TIP TANK STROBE LIGHT WIRING

**EFFECTIVITY:** MODEL 1124/1124A, all serial numbers.

**A. REASON**

To caution operators of possible wire chafing in strobe light recess after maintenance.

**B. REFERENCE**

1124/1124A Westwind Wiring Diagram Manual, Chapter 33-40-01.

**C. PUBLICATIONS AFFECTED**

1124/1124A Westwind Maintenance Manual, Chapter 33-40-00, Paragraph 6B will be revised to include this caution.

**D. DESCRIPTION**

Replacement strobe lamp assembly P/N 31-3172-11 is equipped with a 20 inch shielded cable assembly.

This cable assembly is normally doubled back and tied together at installation, to prevent chafing to adjacent structure or being inadvertently pinched during reassembly of access panels.

Please observe this precaution should replacement of strobe light assembly be required.

# 24-WESTWIND

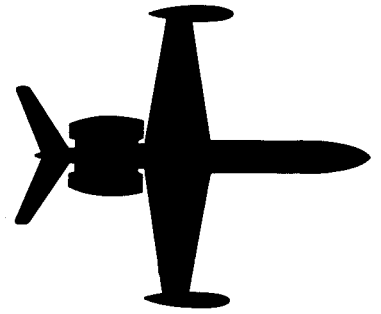

## SERVICE INFORMATION LETTER

SERVICE INFORMATION LETTER NO. 1124-33-099

July 14, 1993

**SUBJECT:** LIGHTS - CABIN FLUORESCENT SUPPORT SYSTEM PARTS  
UPGRADE/REPLACEMENT

**EFFECTIVITY:** MODELS 1124 & 1124A WESTWIND, all serial numbers.

**A. REASON**

To announce upgraded replacement parts for Aerospace Lighting Corporation (ALC) manufactured components of the fluorescent lighting support system.

**B. REFERENCE**

1124/112A Westwind Wiring Diagram Manual, 33-20-02.  
1124/1124A Westwind Illustrated Parts Catalog, 33-20-00.

**C. PUBLICATIONS AFFECTED**

1124/112A Westwind Wiring Diagram Manual, 33-20-02.  
1124/1124A Westwind Illustrated Parts Catalog, 33-20-00.

**D. DESCRIPTION**

When it becomes necessary to replace any of the components of the fluorescent lighting system, follow the chart below for replacement part numbers:

<u>Previous P/N</u>	<u>Description</u>	<u>New P/N</u>	<u>Description</u>
18.994	Inverter	AL-5114	Inverter
18.996	Inverter	AL-0581	Inverter
PI-156-4B	Inverter	AL-0599	Inverter
TR-991	Power Unit	AL-0546	Power Unit
		or AL-5117	Protected Power Unit
TR-992	Power Unit	AL-0514	Power Unit
		or AL-5112	Protected Power Unit

A new series "12" lamp can be used to replace your existing "66" series lamp. These new lamps feature a pigtail incorporating a positive-lock connector. Each series "12" lamp will require two (2) connector assemblies' P/N AL-5113, when changing over from the "66" series. Refer to Table 1 for the 'warm white' or 'cool white' lamps to suit your particular needs.

<b>STANDARD SERIES "12" WARM WHITE LAMPS</b>					
Part Number	Length "X"		Part Number	Length "X"	
	Inches	mm		Inches	mm
AL-1235-150	5.90	150	AL-1235-610	24.01	610
AL-1235-250	9.84	250	AL-1235-630	24.80	630
AL-1235-265	10.43	265	AL-1235-650	25.59	650
AL-1235-320	12.59	320	AL-1235-666	26.22	666
AL-1235-360	14.17	360	AL-1235-700	27.55	700
AL-1235-419	16.49	419	AL-1235-750	29.52	750
AL-1235-420	16.53	420	AL-1235-900	35.43	900
AL-1235-460	18.11	460	AL-1235-911	35.86	911
AL-1235-467	18.38	467	AL-1235-1016	40.00	1016
AL-1235-485	19.09	485	AL-1235-1040	40.94	1040
AL-1235-490	19.29	490	AL-1235-1090	42.91	1090
AL-1235-533	20.98	533	AL-1235-1097	43.18	1097
AL-1235-560	22.04	560	AL-1235-1220	48.03	1220
AL-1235-584	22.99	584	AL-1235-1320	51.96	1320

<b>STANDARD SERIES "12" COOL WHITE LAMPS</b>					
Part Number	Length "X"		Part Number	Length "X"	
	Inches	mm		Inches	mm
AL-1245-150	5.90	150	AL-1245-610	24.01	610
AL-1245-250	9.84	250	AL-1245-666	26.22	666
AL-1245-265	10.43	265	AL-1245-700	27.55	700
AL-1245-320	12.59	320	AL-1245-750	29.52	750
AL-1245-360	14.17	360	AL-1245-900	35.43	900
AL-1245-420	16.53	420	AL-1245-1097	43.18	1097
AL-1245-460	18.11	460	AL-1245-1220	48.03	1220
AL-1245-490	19.29	490	AL-1245-1320	51.96	1320
AL-1245-584	22.99	584			

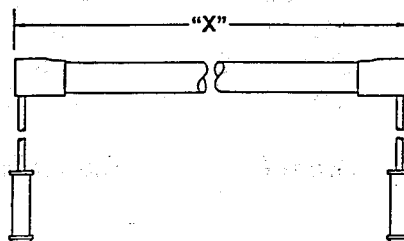

**TABLE 1**

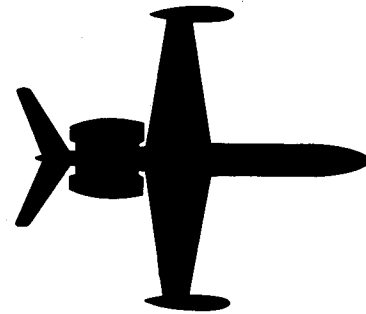

# SERVICE INFORMATION LETTER

SIL NO. 1124-33-099

REVISION 2

December 13, 1995

## TRANSMITTAL SHEET

This sheet transmits Revision 2 to Service Information Letter No. 1124-33-099 dated July 14, 1993, titled "Lights - Cabin Fluorescent Support System Parts Upgrade/Replacement".

### REASON FOR REVISION

To provide maintenance personnel with Aerospace Lighting Corporation's Information Bulletin No. 92-001, titled "Upgrading Series 66 Fluorescent Lighting Systems with AL-12 Series Lamps."

This is a COMPLETE REVISION. Please remove and discard all pages of previous issues and replace with the pages of this revision.

### LIST OF EFFECTIVE PAGES

<u>PAGE NO.</u>	<u>DATE</u>
1	December 13, 1995
2	December 13, 1995

### PREVIOUS REVISIONS OF SIL NO. 1124-05-088

Revision 1, May 25, 1994

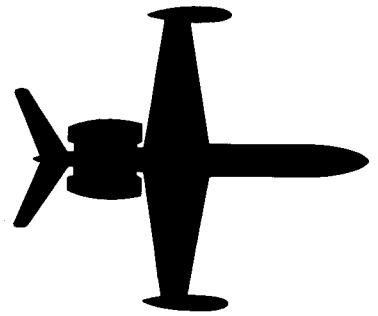

# SERVICE INFORMATION LETTER

SERVICE INFORMATION LETTER NO. 1124-33-099

July 14, 1993

**SUBJECT:** LIGHTS - CABIN FLUORESCENT SUPPORT SYSTEM PARTS  
UPGRADE/REPLACEMENT

**EFFECTIVITY:** MODELS 1124/1124A WESTWINDS, all serial numbers.

**A. REASON**

To announce upgraded replacement parts for Aerospace Lighting Corporation (ALC) manufactured components of the fluorescent lighting support system.

**B. REFERENCE**

- 1124/1124A Westwind Wiring Diagram Manual, 33-20-02.
- 1124/1124A Westwind Illustrated Parts Catalog, 33-20-00.
- 1124/1124A Westwind Service Information Letter No. 1124-33-058.
- 1124/1124A Westwind Service Bulletin No's. 1124-33-121 & 1124-33-131.
- Aerospace Lighting Corporation Information Bulletin No. 92-001, "Upgrading Series 66 Fluorescent Lighting Systems with AL-12 Series Lamps."

R  
R  
R

**C. PUBLICATIONS AFFECTED**

- 1124/1124A Westwind Wiring Diagram Manual, 33-20-02.
- 1124/1124A Westwind Illustrated Parts Catalog, 33-20-00.

**D. DESCRIPTION**

When it becomes necessary to replace any of the components of the fluorescent lighting system, refer to the following chart for replacement part numbers:

**NOTE:** Reference Service Bulletin 1124-33-121 for installation instructions for Protected Power Units P/N AL-5117 & AL-5112.

R  
R

R

SERVICE INFORMATION LETTER NO 1124-33-099

<u>Previous P/N</u>	<u>Description</u>	<u>New P/N</u>	<u>Description</u>
18.994	Inverter	AL-5114	Inverter
18.996	Inverter	AL-0581	Inverter
PI-156-4B	Inverter	AL-0599	Inverter
TR-991	Power Unit	AL-0546	Power Unit
		or AL-5117	Protected Power Unit
TR-992	Power Unit	AL-0514	Power Unit
		or AL-5112	Protected Power Unit
RPU-52	Power Unit	TR-991	Power Unit
		or AL-0546	Power Unit
		or AL-5117	Protected Power Unit
DC-156-4TD	Dimmer Control	AL-0542	Dimmer Control
22-311A	Dimmer Control	AL-0542	Dimmer Control

R A new "AL-12" series lamp can be used to replace existing "66" series lamps. The  
R new lamps feature a pigtail incorporating a positive-lock connector. Each "AL-12"  
R series lamp will require two (2) connector assemblies, P/N AL-5113, when  
R upgrading from the "66" series. Refer to Table 1 for the part numbering system for  
R the "AL-12" series lamps. Instructions for replacing "66" series lamps with  
R "AL-12" series lamps are provided in the attached ALC Information Bulletin No.  
R 92-001, titled "Upgrading Series 66 Fluorescent Lighting Systems with AL-12  
R Series Lamps."

R The FAA considers the accomplishment of ALC's information bulletin a major  
R alteration using FAA approved data. Therefore, to return the aircraft to service per  
R FAR 43.5, a maintenance record entry as outlined in FAR 43.9 must be made, and a  
R Form 337 submitted per the requirement of FAR 43 Appendix B. Astra Jet  
R Corporation is in the process of incorporating ALC's procedures into Service  
R Bulletin No. 1124-33-131, however until this service bulletin is issued, a Form 337  
R must be submitted for upgrades of "66" series lamps to "AL-12" series lamps.

R Example: Lamp P/N AL-1235-1090

AL-12		Lamp type; 12 for 12mm diameter
	35	Color temperature; 35 for Warm White, 45 for Cool White
	-1090	Lamp length in millimeters

R Replacement example: Lamp P/N 6635-1090 is replaced by P/N AL-1235-1090.

R **Table 1**

**INFORMATION BULLETIN**  
**FOR**  
**UPGRADING SERIES 66 FLUORESCENT LIGHTING SYSTEMS**  
**WITH**  
**AL-12 SERIES LAMPS**

Manufactured By:

**AEROSPACE LIGHTING CORPORATION**  
101-8 Colin Drive  
Holbrook, NY 11741

Phone (516) 563-6400  
Fax (516) 563-8781



REVISION STATUS

Revision	Description	Date	Engineering Approval	Quality Assurance Approval
N/C	Original Issue	10/15/92	NM	AR
A	ECO 2017	06/21/95	NM <i>PO</i>	AR <i>AR</i>

**TABLE OF CONTENTS**

<u>PARAGRAPH</u>	<u>TITLE</u>	<u>PAGE</u>
1.0	Introduction	4
2.0	Applicability	4
3.0	Tools	4
4.0	Removal replacement procedures	5
4.1	Lamp Connection (31.85.1A) Removal Procedures	5
4.2	Lamp Connector (AL-5113) Installation Procedures	6
4.3	Fluorescent Lamp (P/N 66XX-XXX) Removal	7
4.4	Fluorescent Lamp (P/N AL12XX-XXX) Installation	7
4.5	Connection Of AL "12" Series Lamp to AL-5113 Connector	8
5.0	System Inspection and Checkout	8
6.0	Returning The Aircraft to Service	8

**LIST OF TABLES**

<u>TABLE</u>	<u>TITLE</u>	<u>PAGE</u>
1	List of Tools	4

**LIST OF FIGURES**

<u>FIGURE</u>	<u>TITLE</u>	<u>PAGE</u>
1	Removal of Locking Ring and Lamp Connector Body	5
2	Lamp Connector (31.85.1A) Removal	6
3	Lamp Connector (AL-5113) Assembly	7
4	Lamp Placement	7
5	Lamp Installation	8

**NOTE**

The technical data contained in this Information Bulletin has been approved by the New York Certification Office of the Federal Aviation Administration.

## 1.0 INTRODUCTION

ALC has modified the form of its existing 66XX-XXX Fluorescent Lamps while retaining their fit and function. This has been done to allow the connection of these lamps to the aircraft wiring through the use of a newly designed AL-5113 Positive Lock Connector in place of the 31.85.1A Lamp Connector.

By using this new "12" Series Lamp and the AL-5113 Connector Assembly the possibilities of arcing at the Lamp/Connector interface have been virtually eliminated. In addition, the design of the AL-5113 Connector Assembly eliminates confusion during installation by using a minimum of parts and standard crimping tools.

This bulletin is intended to assist responsible maintenance personnel in the replacement of 31.85.1A Lamp Connector with AL-5113 Lamp Connector and 66XX-XXX Series Fluorescent Lamps with AL-12XX-XXX Series Fluorescent Lamps.

If additional information or clarification is required concerning this information bulletin, contact:

### AEROSPACE LIGHTING CORPORATION

101-8 Colin Drive  
Holbrook, New York 11741  
(516) 563-6400  
Telex: 64-5135  
Fax: (516) 563-8781  
Attention: Product Support

## 2.0 APPLICABILITY

ALC recommends the procedures specified in this information bulletin be performed on all aircraft fluorescent lighting system installations using the ALC 1/2 inch (12mm) diameter fluorescent lamps. These lamps have part numbers starting with "66" (i.e. 6635-XXX-2S, 6645-XX-2S, etc.).

## 3.0 TOOLS

Table 1 lists the tools that may be required. Each tool is referenced in the applicable procedure.

**Table 1 LIST OF TOOLS**

TOOL	PURPOSE
Flat head screwdriver	To remove lamp connector from lamp end.
Wire Cutters	To remove contact pin from Hi-Voltage wire.
Wire stripper (For No. 20 AWG wire)	To strip wire so lamp connector contact pin can be replaced.
AMP Crimping Tool 90296-1 or equivalent	To crimp 31019 terminal

## 4.0 REMOVAL/REPLACEMENT PROCEDURES

The following procedures provide step-by-step instructions for the removal and replacement of the lamp connectors and fluorescent lamps.

**CAUTION**

Fluorescent lamps and associated high voltage wiring should not be placed in close proximity to flammable materials.

**WARNING**

VOLTAGES CAPABLE OF CAUSING INJURY ARE USED TO POWER THESE FLUORESCENT LIGHTING SYSTEMS. ENSURE POWER IS DISCONNECTED BEFORE PERFORMING ANY OF THE FOLLOWING PROCEDURES.

**4.1 LAMP CONNECTION (31.85.1A) REMOVAL PROCEDURES (SEE FIGURES 1 AND 2)**

The following procedures provide step-by-step instructions for removal of the 31.85.1A lamp connector.

4.1.1 Remove Locking Ring (Item A) from Lamp Connector Body (Item B) by sliding ring away from lamp connector.

4.1.2 Place flat head screwdriver between Lamp Connector Body (Item B) and lamp end. Disengage Lamp Connector Body from lamp end by carefully twisting screwdriver.

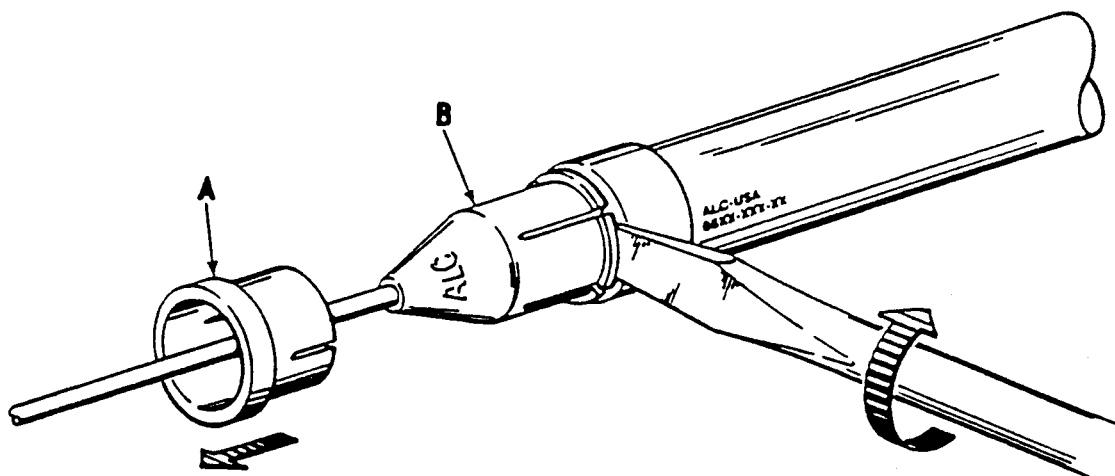

**Figure 1 REMOVAL OF LOCKING RING AND LAMP CONNECTOR BODY**

4.1.3 Remove and discard Contact Pin (Item D) by cutting wire as close as possible to start of insulation.

4.1.4 Remove and discard Contact Spring (Item C), Lamp Connector Body (Item B) and Locking Ring (Item A) from high voltage wire (Item E).

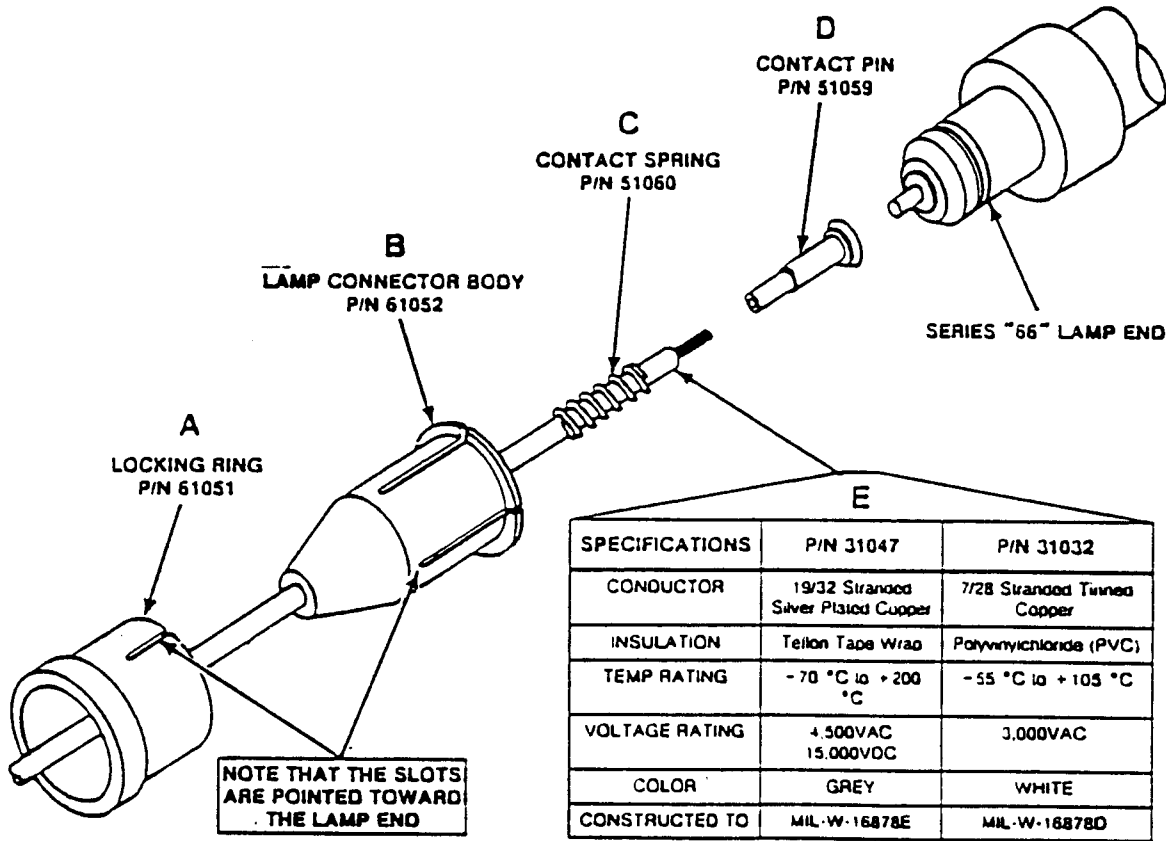

Figure 2 LAMP CONNECTION (31.85.1A) REMOVAL

4.2 LAMP CONNECTOR (AL-5113) INSTALLATION PROCEDURES (SEE FIGURE 3)

Connect a P/N AL-5113 lamp connector (which consists of P/N 31019 terminal and P/N 61183 connector housing) to the end of the High Voltage Wire as follows:

4.2.1 Strip 13/64 inch of insulation from the end of the wire to be connected to the lamp.

**CAUTION**  
To prevent damage to pins, use only specified crimping tool.

4.2.2 Using Amp Crimping Tool 90296-2 or equivalent, crimp a 31019 terminal on the wire from which the insulation was removed.

4.2.3 Insert the wire with the crimped terminal into lamp connector assembly housing (P/N 61183).

4.2.4 Repeat steps 1 through 3 for wire to be connected to other end of lamp.

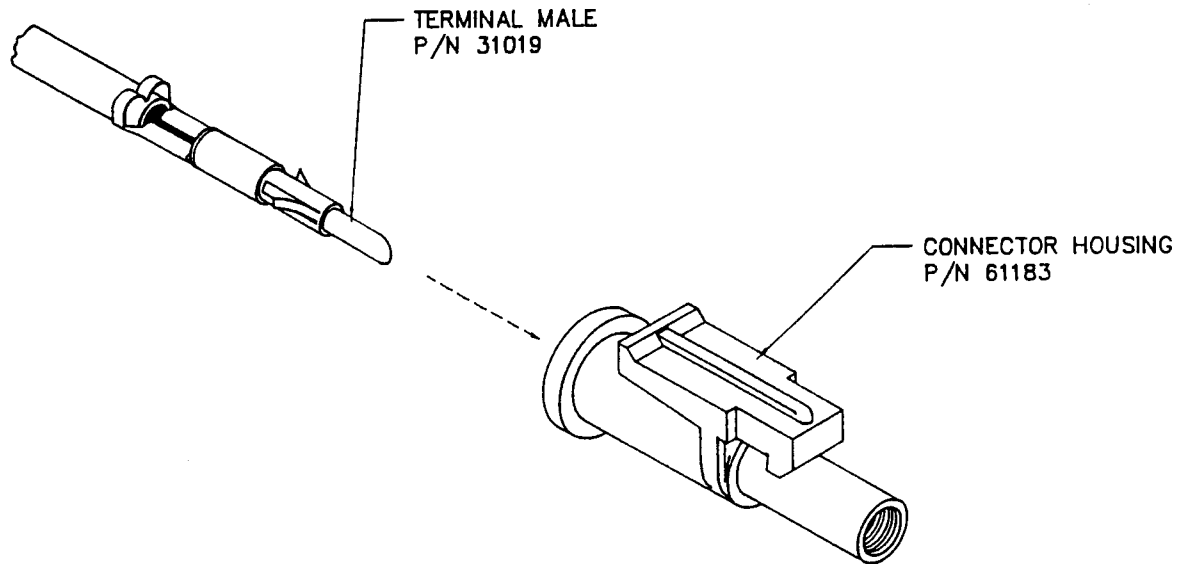

Figure 3 LAMP CONNECTOR (AL-5113) ASSEMBLY

#### 4.3 FLUORESCENT LAMP (P/N 66XX-XXX) REMOVAL

Remove the '66' series fluorescent lamp from the Lamp Holder(s) by gently grasping the lamp with the fingers of both hands immediately next to one lamp holder. While rotating the lamp gently pull it away from the lamp holder. Repeat this procedure for the other lamp holder.

#### 4.4 FLUORESCENT LAMP (P/N AL12XX-XXX) INSTALLATION

Install a series "12", 1/2-inch diameter lamp in the two lamp holders, as follows:

4.4.1 Place lamp on top of the holders (see Figure 4).

#### NOTE

Install the lamp in only one lamp holder at a time. Do not attempt to place the lamp into both lamp holders at the same time.

#### NOTE

The lamp holder has been redesigned to facilitate removal and installation of lamps. The new part, AL-5120B, is a direct replacement for 31.87/AL-0519 Lamp Holder.

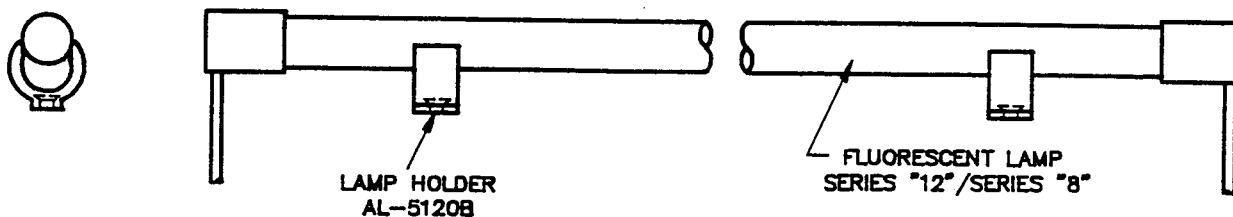

Figure 4 LAMP PLACEMENT

4.4.2 Gently grasp the lamp by placing the fingers of one hand immediately next to the lamp holder and the other hand immediately to the other side of the lamp holder (see Figure 5).

**CAUTION**

Never subject lamp to a bending movement or forcibly push down on lamp so that pressure continues downward on the lamp once it is in place.

4.4.3 Using a light downward pressure, rotate the lamp into the lamp holder until it snaps into place.

**NOTE**

There is no injury from gases should a fluorescent lamp be inadvertently broken. It is recommended that the hands be washed with soap and water to prevent the possibility of a skin reaction to the powders used in the lamp.

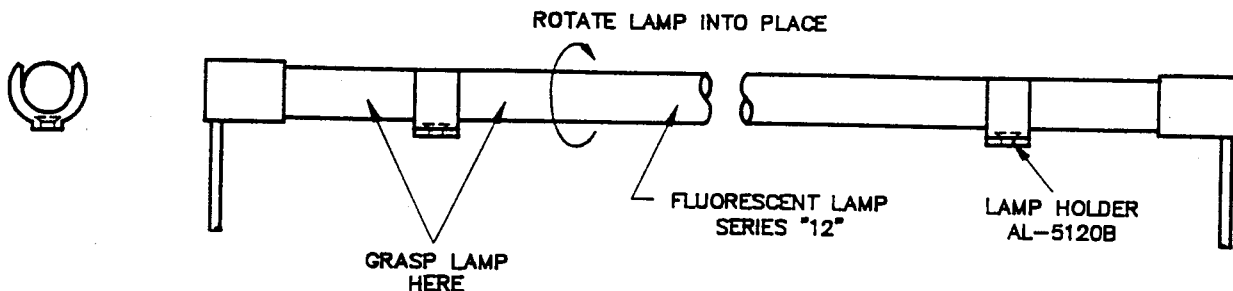

Figure 5 LAMP INSTALLATION

4.2.3 Insert the wire with the crimped terminal into lamp connector assembly housing (P/N 61183).

4.2.4 Repeat steps 1 through 3 for wire to be connected to other end of lamp.

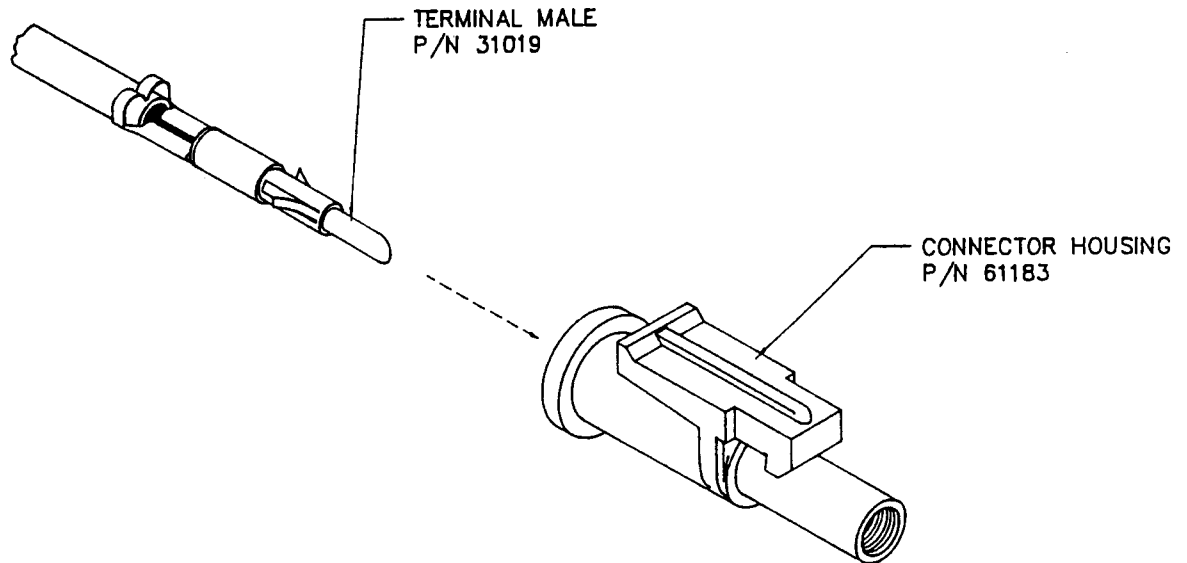

Figure 3 LAMP CONNECTOR (AL-5113) ASSEMBLY

#### 4.3 FLUORESCENT LAMP (P/N 66XX-XXX) REMOVAL

Remove the '66' series fluorescent lamp from the Lamp Holder(s) by gently grasping the lamp with the fingers of both hands immediately next to one lamp holder. While rotating the lamp gently pull it away from the lamp holder. Repeat this procedure for the other lamp holder.

#### 4.4 FLUORESCENT LAMP (P/N AL12XX-XXX) INSTALLATION

Install a series "12", 1/2-inch diameter lamp in the two lamp holders, as follows:

4.4.1 Place lamp on top of the holders (see Figure 4).

#### NOTE

Install the lamp in only one lamp holder at a time. Do not attempt to place the lamp into both lamp holders at the same time.

#### NOTE

The lamp holder has been redesigned to facilitate removal and installation of lamps. The new part, AL-5120B, is a direct replacement for 31.87/AL-0519 Lamp Holder.



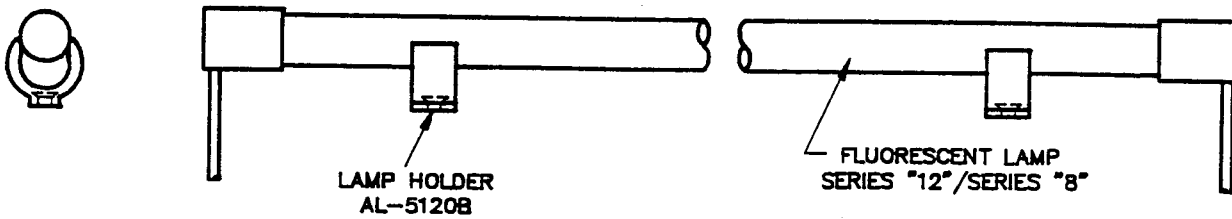

Figure 4 LAMP PLACEMENT

4.4.2 Gently grasp the lamp by placing the fingers of one hand immediately next to the lamp holder and the other hand immediately to the other side of the lamp holder (see Figure 5).

**CAUTION**

Never subject lamp to a bending movement or forcibly push down on lamp so that pressure continues downward on the lamp once it is in place.

4.4.3 Using a light downward pressure, rotate the lamp into the lamp holder until it snaps into place.

**NOTE**

There is no injury from gases should a fluorescent lamp be inadvertently broken. It is recommended that the hands be washed with soap and water to prevent the possibility of a skin reaction to the powders used in the lamp.

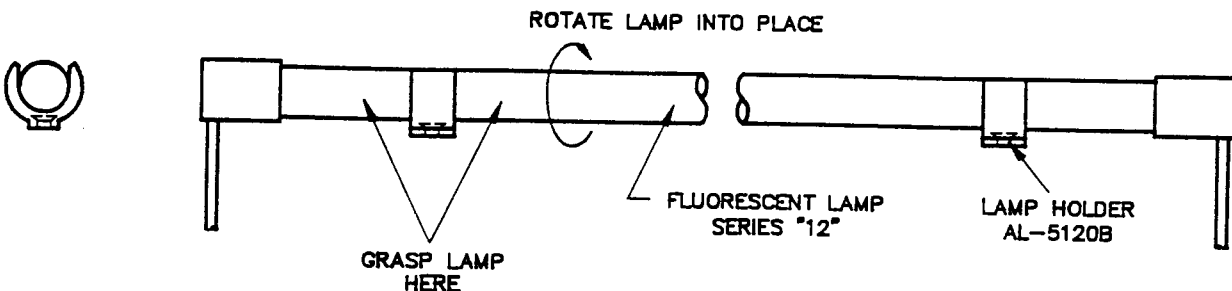

Figure 5 LAMP INSTALLATION

**4.5 CONNECTION OF AL "12" SERIES LAMP TO AL-5113 CONNECTOR**

Connect the pigtail of each lamp end to the appropriate AL-5113 connector by inserting and pushing the AL-5113 into the blue connector at the end of the large pigtail until the locking arm of the AL-5113 snaps into place over the ridge at the end of the connector on the lamp pigtail.

**5.0 SYSTEM INSPECTION AND CHECKOUT**

Visually check all wire connections and lamp mountings for security. Apply system power and observe illumination of lamps. If any malfunction, recheck wiring. If problems persist, contact Aerospace Lighting Corporation Product Support at (516) 563-6400.

**6.0 RETURNING THE AIRCRAFT TO SERVICE**

The FAA considers the accomplishment of this bulletin a major alteration using FAA approved data. Therefore, to return the aircraft to service per FAR 43.5, a maintenance record entry as outlined in FAR 43.9 must be made, and a Form 337 submitted per the requirement of FAR 43 Appendix B.

# SERVICE PUBLICATIONS

# revision notice

SIL NO. 1124-34-012  
Revision No. 1

April 5, 1985

SUBJECT: COAXIAL CABLE CLAMPING

EFFECTIVITY: MODEL 1124/1124A WESTWIND, all serial numbers  
through S/N 435

## A. REASON

To eliminate Avionics systems antenna related problems caused by improper coaxial cable bend radius and/or inner core damage.

## NOTE

Location of defective area may only be properly determined by use of the Time Domain Reflectometry (TDR) tester.

Visual inspection may be used to determine improper coaxial cable bend radius and strain relief, as well as improperly assembled connectors.

## B. DESCRIPTION

- (1) Connect the Time Domain Reflectometry tester to one end of the coaxial cable to be tested. Determine the proper "terminator" that will have the correct "load impedance" for that specific type of coaxial cable. Connect this terminator at the opposite end of the same cable.

SIL 1124-34-012  
Page 1 of 1



INTERNATIONAL INC.  
ISRAEL AIRCRAFT INDUSTRIES INTERNATIONAL INC.

SUBSIDIARY OF ISRAEL AIRCRAFT INDUSTRIES LTD  
BEN GURION AIRPORT, ISRAEL

# 1124-WESTWIND

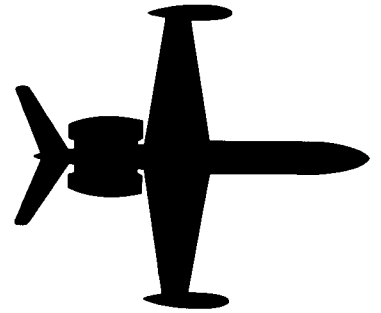

## SERVICE INFORMATION LETTER

---

---

SIL NO. 1124-34-012

February 8, 1985

SUBJECT: COAXIAL CABLE CLAMPING

EFFECTIVITY: MODEL 1124/1124A WESTWIND, all serial numbers  
through S/N 435

### A. REASON

To eliminate Avionics systems antenna related problems caused by improper coaxial cable bend radius and/or inner core damage.

### NOTE

Location of defective area may only be properly determined by use of Time Domain Reflectometry.

Visual inspection may be used to determine improper coaxial cable bend radius and strain relief, as well as improperly assembled connectors. Visual inspection of suspected crushed areas requires access to entire cable run, and will probably prove ineffective.

### B. DESCRIPTION

- (1) Terminate with proper load impedance the end of coaxial cable suspected of damage opposite that to which TDR is connected.



SUBSIDIARY OF ISRAEL AIRCRAFT INDUSTRIES, LTD.  
BEN GURION AIRPORT, ISRAEL

SIL 1124-34-012  
Page 1 of 3

- (2) Determine position of fault(s) as determined by TDR measurement and wave-length or system operational frequency being inspected.
- (3) Gain access to suspect area as required.
- (4) Inspect and repair damaged areas:
  - (a) Cut tywraps that may be overtightened, or are creating severe bend angles to permit strain relief.
  - (b) Should coaxial cable length not be adequate to prevent strain at connectors, install 90° adapters of proper UG/MS type.
  - (c) Inspect for crushed coax under DG cable clamps. Cable should be free to move within clamps.
- (5) Perform TDR test again.
  - (a) Should fault(s) not appear, replace DG clamps with proper size. See Table 1 following.
    - (1) If needed, secure cable bundles with appropriate length of Tywrap. Do not over tighten and crimp coaxial cables.
  - (b) Should fault still exist, repair by replacing defective cable segment using proper UG/MS male/female splices to fit system coaxial cable under test.
  - (c) Should multiple serious faults exist, replace entire coaxial cable run, using as cautions the inspections outlined under Paragraph 4 above.
- (6) Once the TDR test has determined the coaxial cable and associated connectors are acceptable, you may choose to test the system antenna and antenna bonding.
  - (a) Disconnect dummy termination (Paragraph 1 above).

SERVICE INFORMATION LETTER 1124-34-012

- (b) Connect antenna into system, perform TDR from "black box" end. A defective antenna and/or antenna bond will appear in the TDR measurement, at the antenna end of the coaxial cable.

<u>SYSTEM UNDER TEST</u>	<u>COAXIAL CABLE TYPE</u>	<u>SIZE</u>	<u>REQUIRED CLAMP</u>
VHF COM 1, 2, 3 VOR 1, 2 GLIDESLOPE 1, 2 MARKER 1 and/or 2	RG58B/U	0.195	MS21919- DG-5
VHF COM 2 DME 1, 2 ATC 1, 2 FLITE FONE	RG216/U	0.400 to 0.425	MS21919- DG-7
VAUIOUS DATA LINKS	RG174/U	0.100	NONE

END

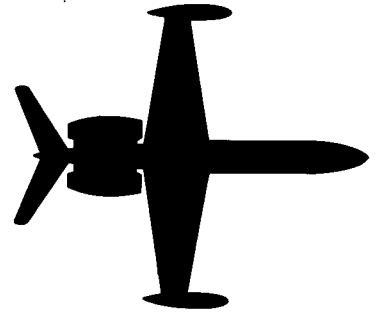

## SERVICE INFORMATION LETTER

---

---

SIL NO. 1124-34-021

February 19, 1985

SUBJECT: INSTALLATION OF CHAFE-GUARD MATERIAL ON WIRE BUNDLES  
AT STATION 269 NEAR EMERGENCY GYRO POWER SUPPLY.

EFFECTIVITY: 1124/1124A - All serial numbers.

A. REASON:

There exists the possibility of damaging wire bundles located immediately aft of the PS 823 Emergency Gyro Power Supply rack during routine removal or installation of the power supply.

B. REFERENCES:

None

C. PUBLICATIONS AFFECTED:

None

D. DESCRIPTION (OR INSTRUCTIONS) (SEE FIGURE 1)

1. Gain access to the PS 823 Emergency Gyro Power Supply installed near station 269 (left-hand side).
2. Remove power supply from rack.
3. Determine presence of wire bundles located immediately aft of the rack installation. Check bundles for prior damage.
4. Select a material available for installation as a protective covering such as:

February 19, 1985



SUBSIDIARY OF ISRAEL AIRCRAFT INDUSTRIES, LTD.  
BEN GURION AIRPORT, ISRAEL

SIL 1124-34-021  
Page 1 of 2

SERVICE INFORMATION LETTER NO. 1124-34-021

- a. Spiral wrap of proper core size.
  - b. Vinyl tubing of 1/8" wall thickness or greater.  
Install using standard lacing or tie-wrap methods.
5. Reinstall PS 823 Power Supply, reinstall panels/bulkheads previously removed and return aircraft to service.

END



# SERVICE PUBLICATIONS revision notice

---

SIL NO. 1124-34-031A  
Revision No. 1

April 29, 1985

SUBJECT: PILOT AND CO-PILOT ANNUNCIATOR PANEL CABLE BUNDLE  
CHAFING/SHORTING

EFFECTIVITY: MODEL 1124/1124A WESTWINDS, all serial numbers.

A. REASON

To eliminate chafing of annunciator wire bundles against an air duct.

B. REFERENCE

Not applicable.

C. PUBLICATIONS AFFECTED

Not applicable.

D. DESCRIPTION

Remove glare shield. Locate the plastic wire bundle clamps that contain the annunciator wiring at the upper, outboard side of each set of autopilot annunciator. Remove the screws holding these clamps to the mounting post. Remove the clamps, and invert them so the wire bundle is relocated below the mounting post to clear the metal air duct clamps.

Reinstall glare shield.



SUBSIDIARY OF ISRAEL AIRCRAFT INDUSTRIES LTD  
BEN GURION AIRPORT, ISRAEL

SB 1124-34-031A  
Page 1 of 1

# 1124-WESTWIND

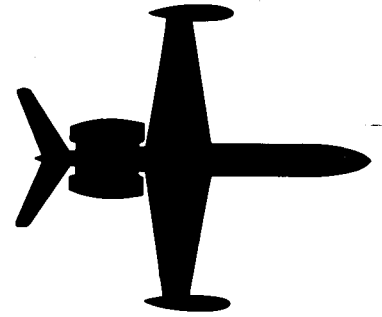

## SERVICE INFORMATION LETTER

---

SIL NO. 1124-34-031

March 13, 1985

SUBJECT: PILOT AND CO-PILOT ANNUNCIATOR PANEL CABLE BUNDLE  
CHAFING/SHORTING

EFFECTIVITY: MODEL 1124/1124A WESTWINDS, all serial numbers.

A. REASON

To eliminate chafing of annunciator wire bundles against an air duct.

B. REFERENCE

Not applicable.

C. PUBLICATIONS AFFECTED

Not applicable.

D. DESCRIPTION

Remove both annunciator panels. Locate the two plastic annunciator wire-bundle clamps near the top of each panel. Remove the mounting-post screws holding these clamps. Reverse their position to move the wire bundle away from the air duct and re-install mounting post screws. Re-install annunciator panels.



INTERNATIONAL INC.  
ISRAEL AIRCRAFT INDUSTRIES INTERNATIONAL INC.

SUBSIDIARY OF ISRAEL AIRCRAFT INDUSTRIES, LTD.  
BEN GURION AIRPORT, ISRAEL

SIL 1124-34-031  
Page 1 of 1

# 24-WESTWIND

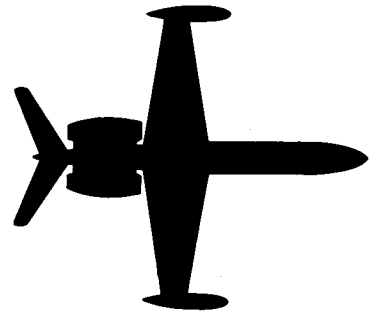

## SERVICE INFORMATION LETTER

---

SIL NO. 1124-34-036

March 20, 1985

SUBJECT: AOA SYSTEM - COMPONENT REPLACEMENT

EFFECTIVITY: MODEL 1124A WESTWIND, all serial numbers.

A. REASON

To provide a procedure to replace the AOA indicator, Teledyne P/N SLZ9944 with P/N SLZ9944A, should replacement become necessary.

B. REFERENCES

Teledyne Avionics Publication SN507, revision B, Ground Test and Adjustment Procedures For The Angle of Attack System.

C. PUBLICATIONS AFFECTED

Teledyne Avionics Publication SN507, revision B, item 3.2.

NOTE

Publication is affected only when SLZ9944 indicator is replaced by SLZ9944A indicator.

D. DESCRIPTION

- (1) Remove and replace AOA indicator in accordance with Chapter 34-10-07 of the 1124/1124A Maintenance Manual.
- (2) Gain access to transmitter located on right side of fuselage at station 86.90. Remove upholstery or panels as required.



SUBSIDIARY OF ISRAEL AIRCRAFT INDUSTRIES, LTD.  
BEN GURION AIRPORT, ISRAEL

SIL 1124-34-036  
Page 1 of 2

- (3) Record the setting of the transmitter to the mounting plate in degrees. Reference Chapter 34-10-07 of the 1124/1124A Maintenance Manual, Figure 402.
- (4) Accomplish the ground check procedure in accordance with Chapter 34-10-07 of the 1124/1124A Maintenance Manual.
- (5) Change the transmitter mounting plate adjustment by a minus 2.1 degrees (i.e., rotate top of probe housing aft) from the setting recorded in Step D.3. Record the new setting.

Example: If the probe calibration was 14.8 degrees for the SLZ9944 indicator, adjust the mounting plate to 12.7 degrees for the SLZ9944A indicator.

- (6) Torque all hardware to 30 inch-pounds.
- (7) Recheck new setting.
- (8) Install upholstery or panels as required.

# 1124-WESTWIND

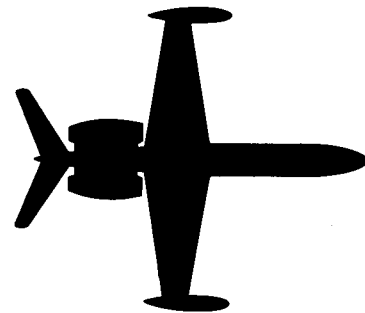

## SERVICE INFORMATION LETTER

---

---

SIL NO. 1124-34-040

April 2, 1985

SUBJECT: RADAR STABILIZATION IMPROVEMENTS

EFFECTIVITY: MODEL 1124/1124A WESTWIND, all serial numbers.

A. REASON

To provide instructions to properly level and adjust the radar antenna and stabilization system.

Performance of these procedures will eliminate excessive ground clutter displays, especially during turns and climb.

B. REFERENCES

1124/1124A Maintenance Manual, Chapter 34-40-01, 34-40-02, 34-40-03, or 34-40-04 as determined by radar system installed.

1124/1124A Service Information Letter No. 1124-22-038.

1124/1124A Service Information Letter No. 1124-22-039.

C. PUBLICATIONS AFFECTED

1124/1124A Maintenance Manual, Chapter 34-40-01, 34-40-02, 34-40-03, or 34-40-04 as determined by radar system installed.

D. INSTRUCTIONS

- (1) Ensure aircraft and vertical gyro are level. Reference SIL No. 1124-22-038 for proper procedure.
- (2) Remove radome; and gain access to #1 vertical gyro.
- (3) Disable transmitter and antenna scan as appropriate for your system. Turn radar system ON.



SUBSIDIARY OF ISRAEL AIRCRAFT INDUSTRIES, LTD.  
BEN GURION AIRPORT, ISRAEL

SIL 1124-34-040  
Page 1 of 4

- (4) Position antenna plate to  $0^{\circ}$  azimuth by reference to azimuth index. Secure antenna plate as required to prevent substantial movement. DO NOT force any vertical movement of antenna dish.
- (5) Set TILT control to  $0^{\circ}$ . Using a calibrated, adjustable level and a rigid straightedge, perform the following measurements to within  $\pm 1/4^{\circ}$ .

NOTE

Use of a standard "bubble" level will not permit proper accuracy.

- (a) Measure across top of radar dish, or the horizontal feeder bar, to establish a roll level. Reference aircraft level points. If an error exists between antenna and aircraft, proceed to Step 6.
  - (b) Measure the yaw axis error by drawing a line between a plumb bob at the tail skid and the center axis of the nose gear strut extended beyond radar antenna. Locate the center of the antenna dish, use a  $90^{\circ}$  angle to extend this line at least 18", and measure between plumb line and antenna centerline extension. If an error exists, proceed to Step 6.
  - (c) Measure the pitch level at the antenna pedestal mounting brackets. Reference exactly  $90^{\circ}$  to aircraft pitch level points. If an error exists, proceed to Step 6.
- (6) Should any angular error exist from Steps 3, 4, or 5 above, remove antenna from airframe mount. Discard any existing shim washers.
    - (a) To remove roll errors, remove antenna base mounting brackets, and elongate the mounting bolt holes (use an arc pattern based on opposite corner mounting hole center) slightly to permit rotation of mounting brackets on nose bulkhead.
    - (b) To remove yaw errors, reinstall mounting brackets, with shims for both mounting bolts (RHS or LHS as required) of identical thickness to correct antenna centerline error.

- (c) To remove pitch errors, install shims (in addition to yaw shims, if necessary) at both mounting bolts (upper or lower as required) to correct antenna base vertical error.
- (d) Reinstall antenna assembly, and repeat Step 5 above as necessary to ensure antenna assembly is accurately centered and leveled to aircraft.

NOTE

This procedure corrects for nose bulkhead assembly and jiggling errors. Installing shims between antenna mounting bracket and bulkhead is preferred to shimming antenna base, since shims may be lost or improperly installed during radar system maintenance.

CAUTION

When using shims between mounting brackets and bulkhead, ensure shims extend beyond mating surfaces to provide proper load bearing area. Use of anodized aluminum washers or sheet metal stock is permissible.

- 7. Once more, protractor the antenna dish for pitch level. Adjust the TILT control for 0° pitch at the antenna dish, reset TILT knob on shaft for 0° reference. Recheck antenna dish.

NOTE

This step assumes radar system tilt circuitry is properly calibrated on the bench.

- 8. Once the antenna system is mechanically accurate (Steps 1 through 7 above) it should not be necessary to repeat the above steps for routine maintenance and troubleshooting.

- (9) Proceed with pitch and roll gain and/or phase adjustments as required, reference Maintenance Manual, Chapter 34 as applicable and/or the radar system vendor's installation manual antenna stabilization adjustment and test procedures.
- (a) It is recommended that the 13% (approximate) roll axis overcompensation as referenced in instructions be accomplished.
  - (b) Be sure to dismount vertical gyro and use a tilt table, to provide proper accuracy and to prevent movement in axis not being adjusted.
  - (c) For future reference, should stabilization require readjustment use a gyro tilt table for the vertical gyro, set TILT control for 0° pitch at antenna dish, and make all pitch/roll measurements at the antenna dish. You may disregard actual aircraft level, and the position of the TILT control.



# 1124-WESTWIND

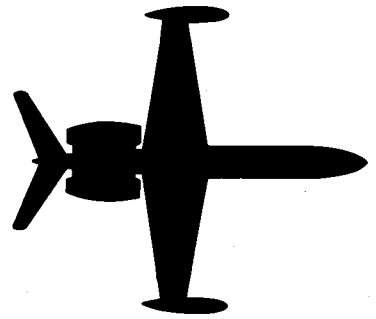

## SERVICE INFORMATION LETTER

---

SIL NO. 1124-34-046

April 5, 1985

SUBJECT: NCS31/A SLANT RANGE CORRECTION

EFFECTIVITY: MODEL 1124 WESTWIND, serial number 152, 154, 174, 181, through 410.

A. REASON

To remove isolation diodes associated with pilots' encoding altimeter and NCS31/A.

B. REFERENCES

1124/1124A Wiring Diagram Manual Chapter 34-50-07.  
Service Letter No. WW-2452 Part B, paragraph 4 & 5, dated Feb. 28, 1980.

C. PUBLICATIONS AFFECTED

1124/1124A Wiring Diagram Manual Chapter 34-50-07.

D. DESCRIPTION

1. Diodes DI200 through DI206 may exist in those Model 1124 aircraft factory equipped with a #2 (copilots) encoding altimeter.
2. Remove these diodes, located at Terminal Strip T-30 (aircraft S/N 239 and prior) or Terminal Strip T-19 (aircraft serial number 240 and subs.), and replace each diode with a short jumper wire.
  - a. Reference procedures in Service Letter No. WW-2452 Part B.



SUBSIDIARY OF ISRAEL AIRCRAFT INDUSTRIES, LTD.  
BEN GURION AIRPORT, ISRAEL

SIL 1124-34-046  
Page 1 of 1

# 24-WESTWIND

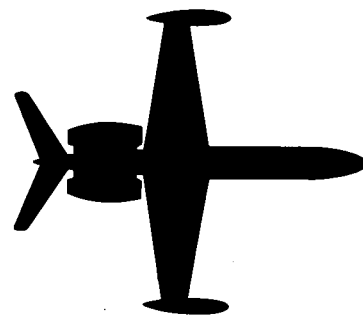

## SERVICE INFORMATION LETTER

---

SIL NO. 1124-34-050

May 27, 1985

SUBJECT: HSI-84/REU-84 MODIFICATION/STATUS CHANGES

EFFECTIVITY: MODEL 1124A WESTWIND, S/N 295 thru 390 using  
Collins HSI-84 copilot HSI.

### A. REASON

1. Modification of HSI-84 to allow for proper dimming control.
2. Conversion of REU-84 to ensure compass flag compatibility and to separate HSI azimuth servo power and DME display power.

### B. REFERENCES

Model 1124A Wiring Diagram Manual chapter 34-50-06 page 21  
and 34-50-05 page 16.

### C. PUBLICATIONS AFFECTED

Model 1124A Wiring Diagram Manual chapter 34-50-06 page 21  
and 34-50-06 page 16.

### D. INSTRUCTIONS

1. Remove HSI-84 from copilot instrument panel and check for compliance with Collins HSI-84 Service Bulletin #2.
  - a. If nameplate has unit part number 622-4141-01X, and SB2 marked out, no further action is required. Reinstall HSI-84.
  - b. If nameplate has unit part number 622-4151-00X, send HSI-84 to authorized Collins service center for accomplishment of HSI-84 Service Bulletin #2.



SUBSIDIARY OF ISRAEL AIRCRAFT INDUSTRIES, LTD.  
BEN GURION AIRPORT, ISRAEL

SIL 1124-34-050  
Page 1 of 2

2. Remove REU-84 from copilots station, right hand sidewall and check part number of unit.
  - a. If part number is 622-4569-001, check mod plate for compliance with REU-84A Service Bulletin #2. If not complied with send unit to authorized Collins service center for service bulletin update.
  - b. If part number is 622-4152-001, send unit to authorized Collins service center for conversion to REU-84A (Service Bulletin #1) and for REU-94A Service Bulletin #2.
  - c. Pull Com 2 bus circuit breaker. Ensure 28 VDC is present at J-1 pin j of REU-84 connector.
  - d. Reset Com 2 bus circuit breaker and pull Com 1 bus circuit breaker. Ensure 28 VDC is present at J-1 pin W of REU-84 connector.
  - e. If criteria of steps c. and d. above are not met, reverse pins J and W. Check Wiring Diagram Manual chapter 34-50-06 page 21, and correct wiring and drawing.
  
3. Reinstall modified HSI-84 and REU-84A.
  - a. Check for proper operation of dimming control on the HSI-84.
    1. Couple VLF to copilot HSI and note absence of decimal point in distance readout. If decimal point appears, check wiring to pin "P" of REU-84 connector.
      - a. Pin "P" should read 28VDC with "VLF2" or "FMS" selected, zero VDC in "VOR" or "RPT NAV1".
    2. Push overhead panel lamp test switch and note all 8's in digital display. If not, check wiring to pin "N" of REU-84 connector (the digit test function will NOT work while HSI is in "VOR" or "RPT NAV1").
      - a. Pin "N" should be grounded in lamp test. Reference Wiring Diagram Manual chapters 34-50-06 page 21, and 34-50-06 page 21 for troubleshooting. A diode (1N645) may exist (cathode to test switch) at or near T156 which can remain in the system.

# SERVICE PUBLICATIONS

# revision notice

SIL NO. 1124-34-052  
Revision No.1

July 5, 1985

SUBJECT: NCS/FMS ELECTRO-MAGNETIC INTERFERENCE PROBLEMS

EFFECTIVITY: MODEL 1124 WESTWIND aircraft, all serial numbers.

## REASON FOR

REVISION: To add an addendum to the text.

1. The EMI/RFI radiation is responsible for interference in VHF Com systems, the symptoms are random squelch breaking, a "birdie" noise (warbling sounds) in com receiver, and pulsing squeals when a signal is being received by the Com system. For the NCS-31A, this is especially true in the frequency range of 127.000 to 133.000 MHz, and is more prevalent on VHF Com 1.
2. The radiation may also confuse the NCS-31A and is a partial cause of keyboard inputs going to the improper RRU frequency readout.
  - a. When the CDPU will not accept keyboard data, or sends data to the wrong RRU (especially when cold or the first power on) and this SIL is accomplished, the problem is internal to the CDPU.

## D. INSTRUCTIONS

- 5a. Upon completion, you will have all wires from terminal 15 and 16 spliced together, and all shields from terminal 17 spliced together. There will be no other wires connected to these splices.
- 6b. Upon completion, you will have a pair of wires from one terminal strip lug spliced together, and the shields from the associated terminal strip lug spliced together. There will be no other wires connected to these splices.

SIL 1124-34-052  
Page 1 of 1



SUBSIDIARY OF ISRAEL AIRCRAFT INDUSTRIES LTD  
BEN GURION AIRPORT, ISRAEL

# 1124-WESTWIND

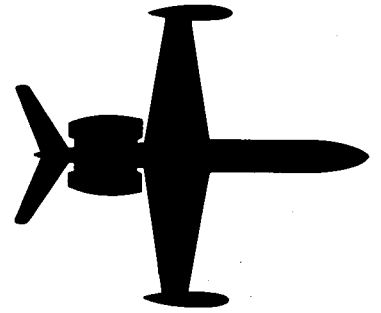

## SERVICE INFORMATION LETTER

---

---

SIL NO. 1124-34-052

June 5, 1985

SUBJECT: NCS/FMS ELECTRO-MAGNETIC INTERFERENCE PROBLEMS

EFFECTIVITY: MODEL 1124 WESTWIND aircraft, all serial numbers.

A. REASON

To eliminate the problems caused by Electro-Magnetic Interference (EMI) and Radio Frequency Interference (RFI).

B. REFERENCES

1124 Wiring Diagram Manual, Chapters 34-50-12 and 34-50-13.

C. PUBLICATIONS AFFECTED

1124 Wiring Diagram Manual, Chapters 34-50-12 and 34-50-13.

D. INSTRUCTIONS

1. Remove all power from aircraft.
2. Gain access to terminal strip T-6 (A/C prior to S/N 240) or T-160 (S/N 240 and subs). Terminal strip is located on vertical center instrument panel mount, copilot side, outboard.
3. Effectivity, all aircraft serial numbers. Remove all shielded wires from terminals 15 and 16 of T-6 (T-160) and remove shield ground wire(s) from terminal 17.
4. Cut back cable sheath and ties to locate splices where shield returns connect. Cut all shield return wires originally going to terminal 17, splice together (maximum length 2") and insulate. Trim shield braids uniformly, not to exceed a length of 1 inch.

SIL 1124-34-052  
Page 1 of 2



SUBSIDIARY OF ISRAEL AIRCRAFT INDUSTRIES, LTD.  
BEN GURION AIRPORT, ISRAEL

5. Cut center conductors of all wires removed from terminals 15 and 16 to a length not to exceed 2 inches beyond shield and splice together.

CAUTION

Any short circuit between the shield braid and center conductor in the preceding or following steps will cause failure of the NCS-31 CDPU.

6. Effectivity, aircraft S/N 187 thru 222.  
Perform the above procedure with each terminal strip pair in sequence. Ensure each terminal pair is properly isolated from the other terminal pairs.
  - A. Begin with T-6 terminals 1 and 2, taking each terminal pair, in turn, until the pair on terminals 13 and 14 are completed. Do not interfere with any other wires at T-6.

# 24-WESTWIND

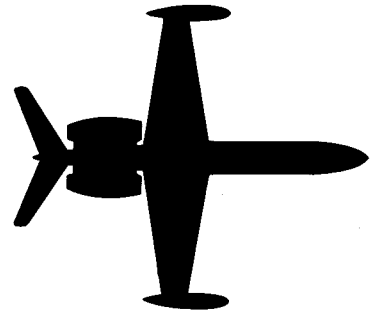

## SERVICE INFORMATION LETTER

---

---

SIL NO. 1124-34-053

August 9, 1985

SUBJECT: FMS-90/LRN-85/GNS-500 BACKLIGHTING

EFFECTIVITY: 1124/1124A S/N's prior to 392 with FMS-90/LRN-85/  
GNS-500 installed as #1 and/or #2 VLF NAV System.

A. REASON

Ensure proper strapping for maximum backlighting of  
Computer Display Units and Receiver Tune Units.

B. REFERENCES

1124 Wiring Diagram Manual Chapters 34-60-01, 34-60-02 and  
34-60-03.

C. PUBLICATIONS AFFECTED

1124 Wiring Diagram Manual, Chapters 34-60-01, 34-60-02 and  
34-60-03.

D. DESCRIPTION

- (1) A continuity check of the Receiver Tune Unit (RTU)  
connector is required to ensure proper voltage source  
for the backlighting of the RTU.
  - A. Check the RTU-90 part number. If it ends in an odd  
number, 0 to 5VDC from center instrument panel  
dimmer must be observed at plug B207J2-8, originating  
at T156-18.

Should the RTU P/N end in an even number, 0 to  
28VDC must be observed from console edge light  
dimmer, originating from a splice at wire L17E20  
near the passenger oxygen control panel.



SUBSIDIARY OF ISRAEL AIRCRAFT INDUSTRIES, LTD.  
BEN GURION AIRPORT, ISRAEL

SIL 1124-34-053

Page 1 of 2

- B. At RTU connector J2 see that the jumpers from pins 10 and 11 return to airframe ground at a point on the instrument panel support near the RTU.
- (2) A continuity check of the Computer Display Unit (CDU-90/CDU-85) is required to ensure proper strapping for the CDU backlighting.
- A. At CDU-90/85 connector check for continuity between pins "D", "N" and "J." These three pins should read 0 to 5VDC with console dimmer rotation.
  - B. At CDU-90/85 connector check for continuity between pins "E", "P" and "H." These three should read short to airframe ground, and must be grounded to a point near the CDU on panel support or the pedestal.
  - C. At Global CDU connector check for continuity between pin "P" and airframe ground. Pin must be grounded to a point near the CDU in the pedestal.



# **24-WESTWIND**

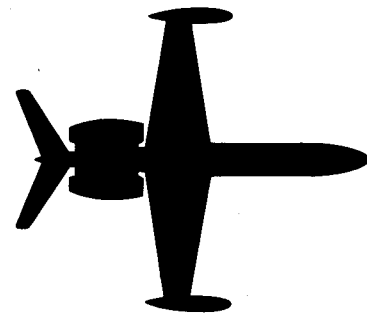

## **SERVICE INFORMATION LETTER**

**SIL NO. 1124-34-073**

**REVISION 1**

**May 29, 1990**

(This service information letter dated May 29, 1990, supersedes Service Information Letter No. 1124-34-073 dated July 10, 1989 in its entirety.)

**SUBJECT: WEATHER RADAR - COLLINS IND-300 WEATHER RADAR  
INDICATOR MANDATORY SERVICE BULLETIN**

**EFFECTIVITY: ALL 1124/1124A MODEL WESTWINDS WITH COLLINS  
IND-300 WEATHER RADAR INDICATOR INSTALLED**

**A. REASON**

Several incidents have been reported of smoke being emitted from IND-300 indicators in the cockpit. Investigation of the affected indicators revealed an arc between an internal resistor in the high voltage power supply to the chassis. This arc caused the outer cover of the high voltage power supply to smolder and emit smoke.

**B. REFERENCE**

Rockwell Collins Mandatory Service Bulletin 18 to the IND-300 radar display.

**C. PUBLICATIONS AFFECTED**

None

**D. DESCRIPTION**

Rockwell Collins Mandatory Service Bulletin Number 18 has been issued to correct the problem. This bulletin is applicable to all IND-300 indicators in the field that do not have Mod No. 18 marked off on the mod plate. The IND-300 radar indicator can be identified as Collins P/N's 622-4331-001, 622-4331-002 or 622-4331-003. Contact your Rockwell Collins dealer for further information.

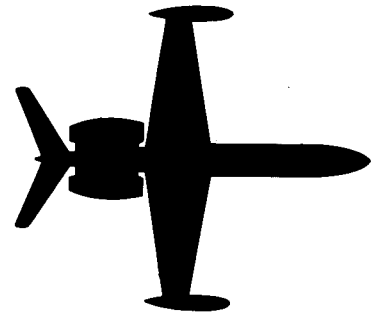

# SERVICE INFORMATION LETTER

SIL NO. 1124-34-086

REVISION 1

April 4, 1991

## TRANSMITTAL SHEET

This sheet transmits Revision 1 to Service Information Letter No. 1124-34-086, dated February 13, 1991, titled "Navigation - Weather Radar Antenna."

### REASON FOR REVISION

To add CAUTION to prevent further damage to the tilt drive mechanism.

This is a COMPLETE REVISION. Remove and discard all pages affected by this revision.

### LIST OF EFFECTIVE PAGES

<u>PAGE NO.</u>	<u>DATE</u>
1	April 4, 1991

### PREVIOUS REVISIONS OF SIL 1124-34-086

None

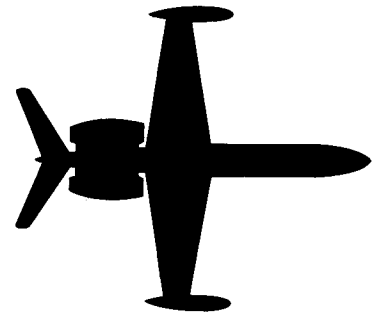

# SERVICE INFORMATION LETTER

SERVICE INFORMATION LETTER NO. 1124-34-086

February 13, 1991

**SUBJECT:** NAVIGATION - WEATHER RADAR ANTENNA

**EFFECTIVITY:** MODEL 1124/1124A WESTWIND, all serial numbers with Collins ANT-318 or ANT-318A Weather Radar Antenna installed.

**A. REASON**

Some radar installations are experiencing damage to the tilt mechanism in the form of broken teeth on the sector or tilt motor gear.

**B. REFERENCE**

Collins Service Bulletin No. 6 to the ANT-310, ANT-310A, ANT-312, ANT-312A, ANT-318 and ANT-318A Weather Radar Antennas, titled, IMPROVE TILT SECTOR GEAR RELIABILITY.

**C. PUBLICATIONS AFFECTED**

- R 1124 Westwind Airplane Flight Manual.
- R 1124A Westwind Airplane Flight Manual.

**D. DESCRIPTION**

Referenced service bulletin modifies the ANT-318 and ANT-318A Weather Radar Antennas by replacing the Tilt Sector Gear and the Tilt Motor Assembly of the antenna drive mechanism with a new and improved Tilt Sector Gear and Tilt Motor Assembly.

Contact your Collins dealer for further details.

- R **CAUTION:** TO PREVENT FURTHER DAMAGE TO TILT DRIVE
- R MECHANISM, ENSURE RADAR SYSTEM IS TURNED OFF
- R UNTIL ATTITUDE REFERENCE SYSTEMS ARE FULLY
- R ERECT AND VALID ATTITUDE DISPLAYS ARE PRESENT.

# 24-WESTWIND

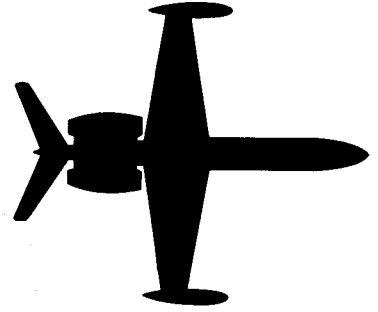

## SERVICE INFORMATION LETTER

---

SERVICE INFORMATION LETTER NO. 1124-34-112

August 23, 1995

---

**SUBJECT:** NAVIGATION - WEATHER RADAR ANTENNA

**EFFECTIVITY:** MODEL 1124/1124A WESTWIND, all serial numbers with Collins ANT-318 or ANT-318A Weather Radar Antenna installed.

**A. REASON**

Some radar installations are experiencing damage to the tilt mechanism in the form of broken teeth on the sector or tilt motor gear.

**B. REFERENCE**

Collins Service Bulletin No. 6 to the ANT-310, ANT-310A, ANT-312, ANT-312A, ANT-318 and ANT-318A Weather Radar Antennas, titled, IMPROVE TILT SECTOR GEAR RELIABILITY.

**C. PUBLICATIONS AFFECTED**

None.

**D. DESCRIPTION**

Referenced service bulletin modifies the ANT-318 and ANT-318A Weather Radar Antennas by replacing the Tilt Sector Gear and the Tilt Motor Assembly of the antenna drive mechanism with a new and improved Tilt Sector Gear and Tilt Motor Assembly.

Contact your Collins dealer for further details.

**CAUTION:** TO PREVENT FURTHER DAMAGE TO TILT DRIVE MECHANISM, ENSURE RADAR SYSTEM IS TURNED OFF UNTIL ATTITUDE REFERENCE SYSTEMS ARE FULLY ERECT AND VALID ATTITUDE DISPLAYS ARE PRESENT.

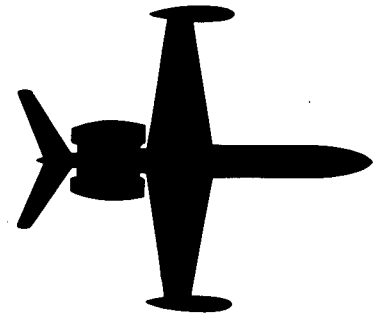

## SERVICE INFORMATION LETTER

---

SERVICE INFORMATION LETTER NO. 1124-51-105

August 3, 1994

**SUBJECT:** STRUCTURES - INSPECTION AND PREVENTATIVE MAINTENANCE OF AIRCRAFT STRUCTURE FOR CORROSION AT ANTENNA MATING SURFACES.

**EFFECTIVITY:** MODEL 1124 WESTWIND, all serial numbers.

**A. REASON**

To provide information for the inspection of aircraft structure for corrosion and preventative maintenance at antenna mating surfaces.

**B. REFERENCE**

None

**C. PUBLICATIONS AFFECTED**

None

**D. DESCRIPTION**

Aircraft structural corrosion under antennas is commonly caused by moisture permeating between the two surfaces. It also may be caused by aircraft washing chemicals and paint stripper.

It is recommended that the outer edges of antennas be inspected periodically for cracked or missing sealant. Also inspect antenna bases for cabin pressure leaks by evidence of dark streaks projecting from the sealed areas.

If the outer edge of an antenna shows any of the above discrepancies, it is recommended that the antenna be removed and the mating surfaces, inspected for corrosion and cleaned as necessary. It is also recommended to apply alodine treatment to exposed contact areas to ensure long term antenna bonding and to assist in the prevention of future corrosion.

During aircraft stripping and repainting, removal of all external antennas is suggested as a means to identify and correct previously undetected corrosion hidden under external antenna bases.

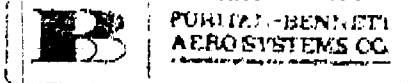

COMPONENT MAINTENANCE MANUAL  
114620 AND 114420

*Free*

CONE & SEAL ASSY - 210542

CONE & SEAL ASSY WITH PURGE VALVE - 210542-01

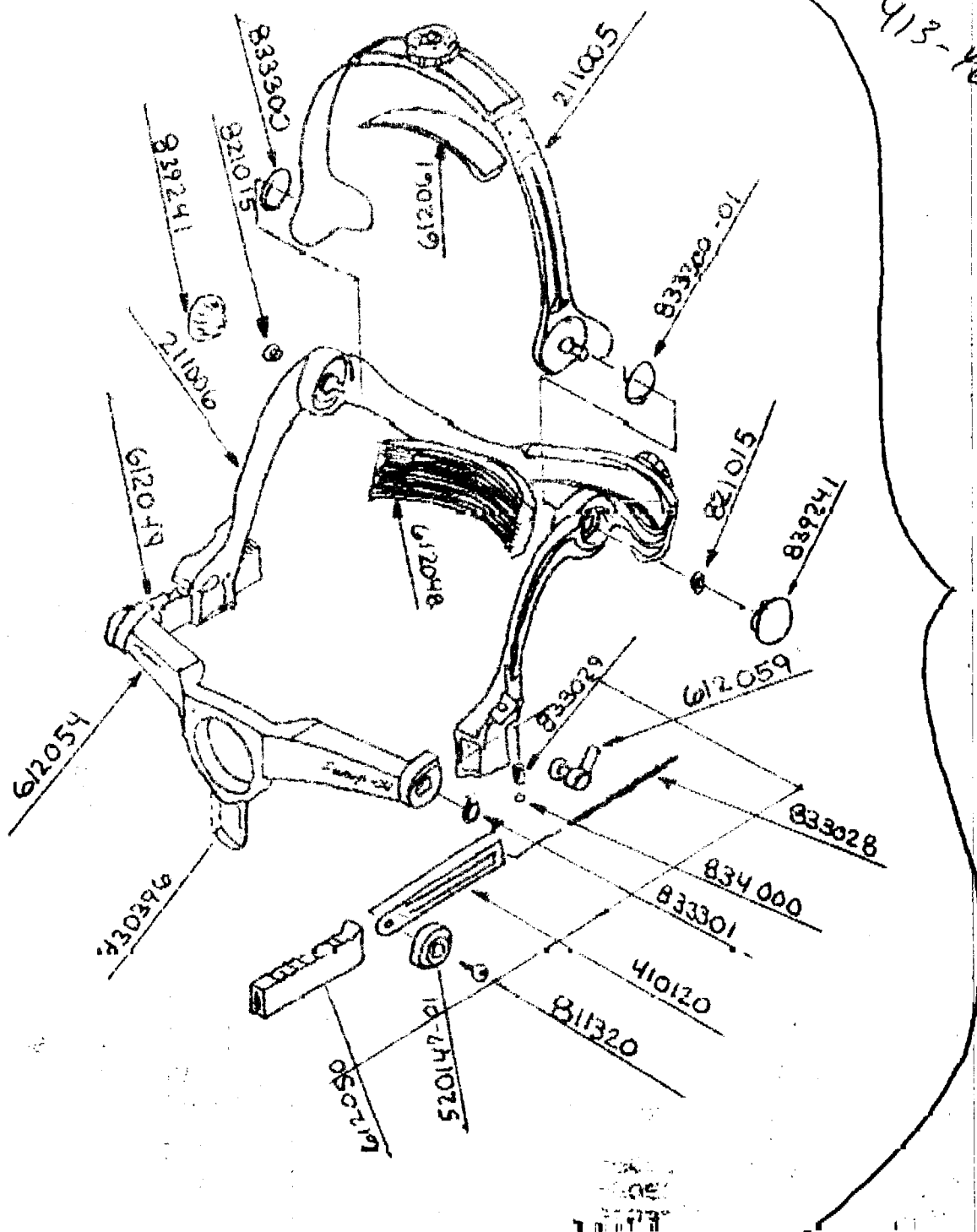

913-469-5400

Harness  
Assy  
211007

135  
135

3004

90006  
40700  
DFKCY

11/11/93  
11/11/93

# 1124-WESTWIND

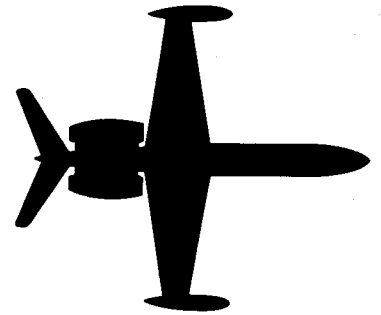

## SERVICE INFORMATION LETTER

---

---

SIL NO. 1124-35-015

February 11, 1985

SUBJECT: OXYGEN SYSTEM - TIME UNIT CHANGES

EFFECTIVITY: MODEL 1124/1124A, all serial numbers.

A. REASON

To remove the 5000 hour or 5 year overhaul requirement on oxygen regulators.

B. REFERENCES

Puritan Bennet Memo dated June 26, 1980.  
S.I.L. No. #15  
1124 Maintenance Manual, Chapter 5.

C. PUBLICATIONS AFFECTED

1124 Maintenance Manual, Chapter 5.

D. DESCRIPTION

The following changes have been approved for incorporation into the replacement and overhaul schedule of 1124 Maintenance Manual, Chapter 5.

<u>Component</u>	<u>Part No.</u>	<u>Overhaul or Replace</u>
Regulator	101202-11	O/C



SUBSIDIARY OF ISRAEL AIRCRAFT INDUSTRIES, LTD.  
BEN GURION AIRPORT, ISRAEL

SIL 1124-35-015  
Page 1 of 1

# 1124-WESTWIND

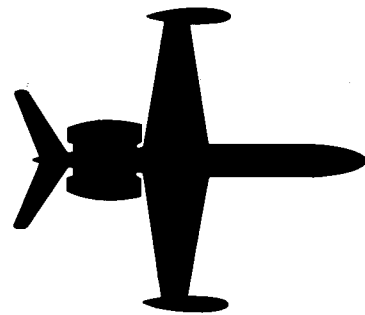

## SERVICE INFORMATION LETTER

---

---

SIL NO. 1124-35-035

March 20, 1985

SUBJECT: STOWAGE OF EROS OXYGEN MASK P/N MC-1013-12

EFFECTIVITY: MODEL 1124/1124A WESTWINDS, serial number 187  
and subs. with Eros Oxygen Masks.

A. REASON

To prevent mask leakage around the facial seal due to Heat Soaking.

B. REFERENCES

1124/1124A Illustrated Parts Catalog, Chapter 35.

C. PUBLICATIONS AFFECTED

None

D. INSTRUCTIONS

Due to the method of stowage of the oxygen mask and inflatable head harness, the oxygen mask facial seal becomes deformed from on-ramp heat soaking. This harness is difficult to deflate for stowage and can inflate in the stowed position if the oxygen shut-off valve is not secure. This increases the harness size and puts pressure on the facial seal which becomes distorted when heat soaked. It is recommended that harness be sufficiently deflated so as not to put pressure on mask, or stow masks with harness out of the mount while aircraft is on the ground in direct sunlight.



SUBSIDIARY OF ISRAEL AIRCRAFT INDUSTRIES, LTD.  
BEN GURION AIRPORT, ISRAEL

SIL 1124-35-035  
Page 1 of 1



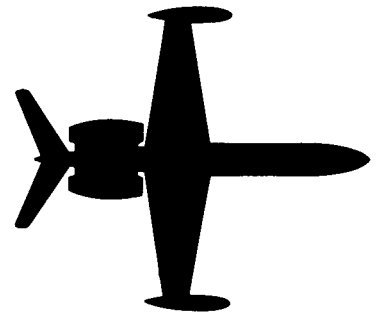

# SERVICE INFORMATION LETTER

---

---

SERVICE INFORMATION LETTER NO. 1124-35-082

August 8, 1990

**SUBJECT:** OXYGEN - EROS MC-SERIES MASK-REGULATOR ASSEMBLY  
OVERHAUL INTERVAL INCREASE.

**EFFECTIVITY:** MODEL 1124/1124A WESTWIND, with EROS Mask-Regulator  
Assemblies installed.

**A. REASON**

Due to reliability experience, Scott Aviation has recommended a revised maintenance policy for MC Series Mask-Regulator Assemblies.

**B. REFERENCE**

Letter from Scott Aviation to all equipment manufacturers.  
1124/1124A Westwind Maintenance Manual, Chapter 5-10-00.

**C. PUBLICATIONS AFFECTED**

1124/1124A Westwind Maintenance Manual, Chapter 5-10-00.

**D. DESCRIPTION**

The 1124/1124A Westwind Maintenance Manual, Chapter 5-10-00,  
Overhaul/Replacement Schedule for the EROS Mask-Regulator Assembly  
P/N MC-1013-01 or -02 is revised as follows:

3 years - factory functional test

6 years - factory overhaul

**SERVICE INFORMATION LETTER NO.1124-35-082**

**The approved agency to perform these maintenance tasks is:**

**Scott Aviation  
225 Erie Street  
Lancaster, NY 14086  
Phone: 716-683-5100  
Fax: 716-681-1089**

**Advance notice of mask shipment is recommended and can expedite return.**

# **24-WESTWIND**

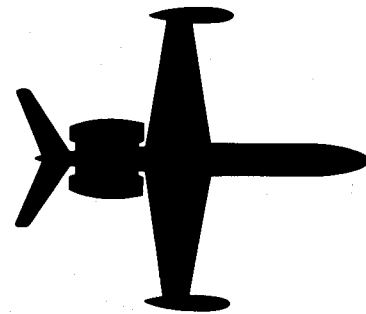

## **SERVICE INFORMATION LETTER**

**SERVICE INFORMATION LETTER NO. 1124-35-083**

**October 1, 1990**

**SUBJECT: OXYGEN - SHUTOFF VALVE LUBRICATION**

**EFFECTIVITY: MODEL 1124/1124A WESTWIND, all serial numbers.**

**A. REASON**

To provide lubrication information for the oxygen shut off valve.

**B. REFERENCES**

None.

**C. PUBLICATIONS AFFECTED**

None.

**D. DESCRIPTION**

If an oxygen shut off valve becomes stiff and hard to operate, it may be lubricated with grease which meets MIL SPEC MIL-G-27617.

There are several commercial brands which meet this MIL SPEC.  
The vendor listed below has several brands available and can provide information on them:

Aviation Consumables, Inc.  
P.O. Box 27205  
4000 Red Bank Road  
Cincinnati, Ohio 45227  
Phone: 513-561-9977

# **24-WESTWIND**

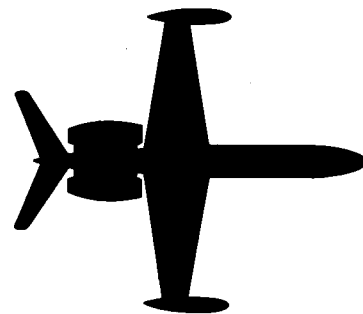

## **SERVICE INFORMATION LETTER**

---

---

SIL NO. 1124-52-034

April 24, 1985

SUBJECT: PREVENTION OF WATER FREEZING IN CABIN DOORS AND  
BAGGAGE DOORS

EFFECTIVITY: 1124/1124A WESTWINDS, all serial numbers.

A. REASON

To alert operators of precautions which need to be followed after the aircraft is washed or after being exposed to heavy precipitation while parked.

B. REFERENCES

None

C. PUBLICATIONS AFFECTED

None

D. DESCRIPTION

The possibility exists for moisture to be introduced into door seals and door latch mechanisms during routine aircraft washing and/or by being exposed to heavy precipitation while parked outdoors.

It is recommended that the entrance, and baggage doors be opened and checked for the presence of moisture which may freeze and cause difficulty in operating latches and doors.

Wipe down seals thoroughly and spray or wipe on a light coating of silicone lubricant.

Check door latch mechanisms and their covers for moisture and spray latch mechanisms with LPS-2, WD-40 or an equivalent product.



SUBSIDIARY OF ISRAEL AIRCRAFT INDUSTRIES, LTD.  
BEN GURION AIRPORT, ISRAEL

SIL 1124-52-034  
Page 1 of 1

# SERVICE PUBLICATIONS revision notice

---

SIL No. 1124-56-029  
Revision No. 1

May 2, 1989

SUBJECT: COCKPIT SIDE WINDOWS - IMPROVED REMOVAL/INSTALLATION  
PROCEDURES

## CANCELLATION NOTICE

This service bulletin is hereby cancelled forthwith. The information contained in this service information letter is presently being revised in its entirety and will be published at a later date.

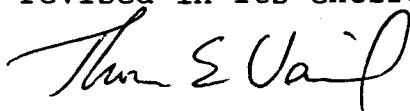

Thomas Vail  
Manager, Technical Services

# 1124-WESTWIND

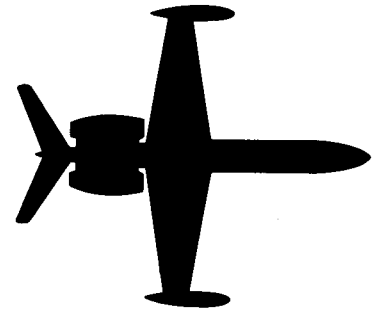

## SERVICE INFORMATION LETTER

---

---

SIL NO. 1124-56-029

March 20, 1985

SUBJECT: COCKPIT SIDE WINDOWS - IMPROVED REMOVAL/INSTALLATION  
PROCEDURES

EFFECTIVITY: MODEL 1124 WESTWIND, all serial numbers.

A. REASON

To provide an improved method for replacement of the cockpit side-windows.

B. REFERENCES

1124 Aircraft Maintenance Manual, Chapter 56.

C. PUBLICATIONS AFFECTED

1124 Maintenance Manual, Chapter 56.

D. DESCRIPTION

Instructions outlined in this Service Information Letter revise the disassembly, replacement, and reassembly procedures currently present in the Aircraft Maintenance Manual. The operator is advised to refer to the instructions contained herein when replacing the window panels. Changes will be made to Chapter 56 of the Maintenance Manual to reflect the new procedures during the next scheduled revision.

- (a) Remove direct-vision window.
- (b) Remove cockpit interior furnishing as required to facilitate removal of all fasteners securing pilot side-window retainer (See Figure 1).



SUBSIDIARY OF ISRAEL AIRCRAFT INDUSTRIES, LTD.  
BEN GURION AIRPORT, ISRAEL

SIL 1124-56-029  
Page 1 of 5

- (c) Mask all areas surrounding side-window retainer.
- (d) Remove all perimeter fasteners as indicated in Figure 1 (numbers 37-39).
- (e) Separate retainer/window assembly from fuselage structure.
- (f) Proceed with removal and replacement of side-window panels and spacer as outlined in Chapter 56-10-00. During installation of the new window panels, attention should be given to the fit of the outer window panel into the side-window retainer. To ensure the best overall fit, the .250 in. fastener holes previously drilled in the new window panel may be enlarged to a maximum diameter of .285 inch. Minimum edge distance of all holes must be maintained at 1.7D in all cases. Insert all fasteners loosely. Tighten the middle of the panel sides, working out to the corners in a crisscross pattern.
- (g) Final torque all window double-panel fasteners to 40-45 inch-pounds.
- (h) Prior to reinstallation of the side-window retainer, remove all old sealant from the faying surfaces of the airframe structure and window retainer. Assure both surfaces are clean prior to application of new sealant.

Refer to the aircraft Maintenance Manual, Chapter 53-00-00, Fuselage Sealing, General Maintenance Practices for instructions covering proper sealing of side-window retainer to fuselage. Applicable sealant is: 3M-EC1239, Class B.

- (i) Reinstall retainer using cleaned surface hardware. Ensure EC1239 sealant is applied to the underside of each fastener before assembly.
- (j) Assemble all fasteners to airframe loosely. Tighten fasteners gradually in a crisscross pattern, with attention given to even application of torque, drawing retainer into fuselage structure. Final torque all retainer fasteners to 30-35 inch-pounds.
- (k) Remove excess EC1239 sealant from all areas as necessary. Fair in joints between window/retainer and retainer/fuselage skins with excess sealant.

- (l) After curing of sealant, refinish retainer and fasteners as required.
  - (m) Reinstall interior furnishings.
  - (n) Remove protective covering and clean windows. Refer to Chapter 56-00-00.
2. Procedures for replacement of the copilot's side-window are essentially identical to those for the pilot's side. (Reference Figure 2 for fastener identification).



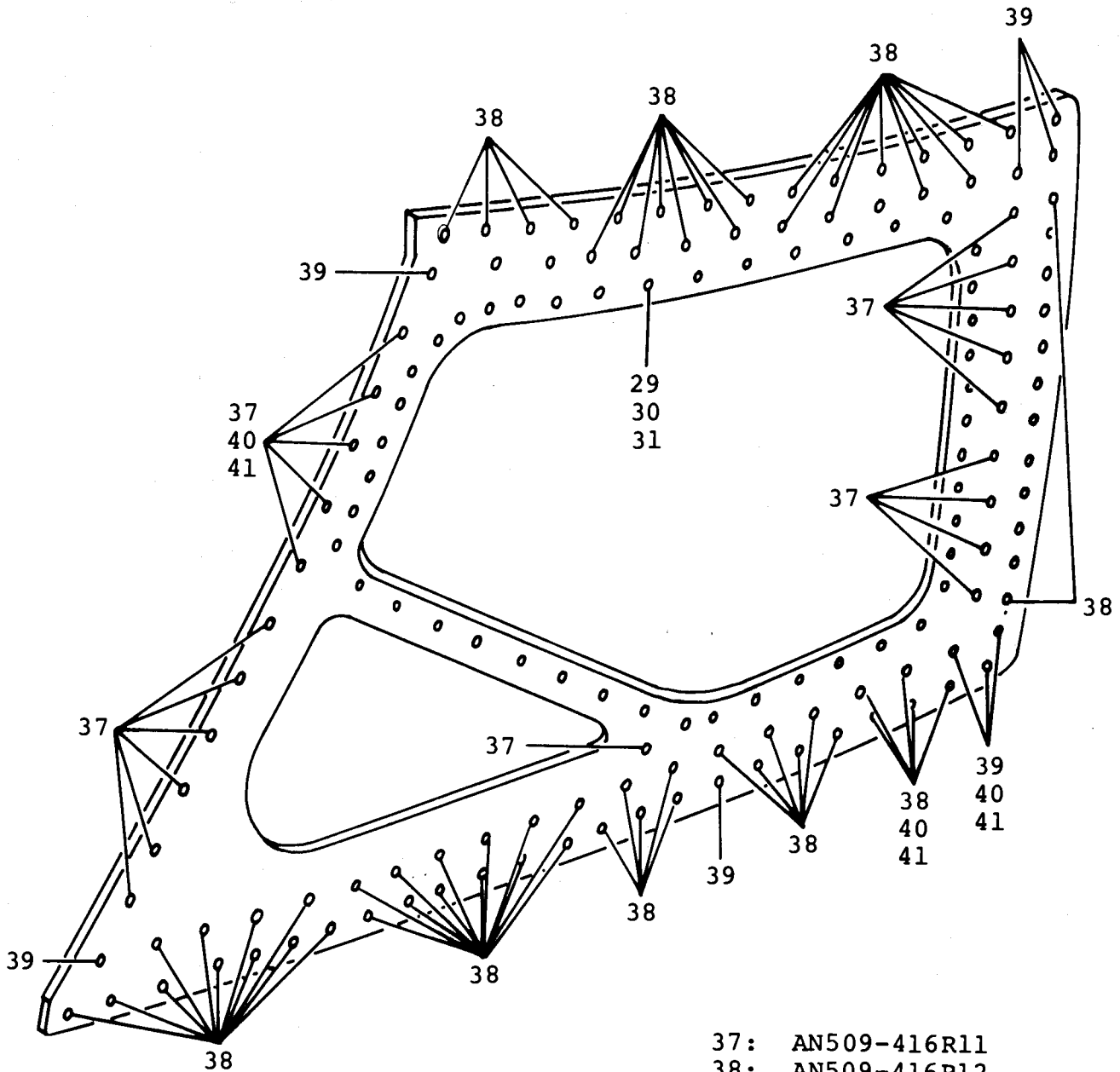

- 37: AN509-416R11
- 38: AN509-416R12
- 39: AN509-416R13

SCREW SIZE LOCATOR

FIGURE 1

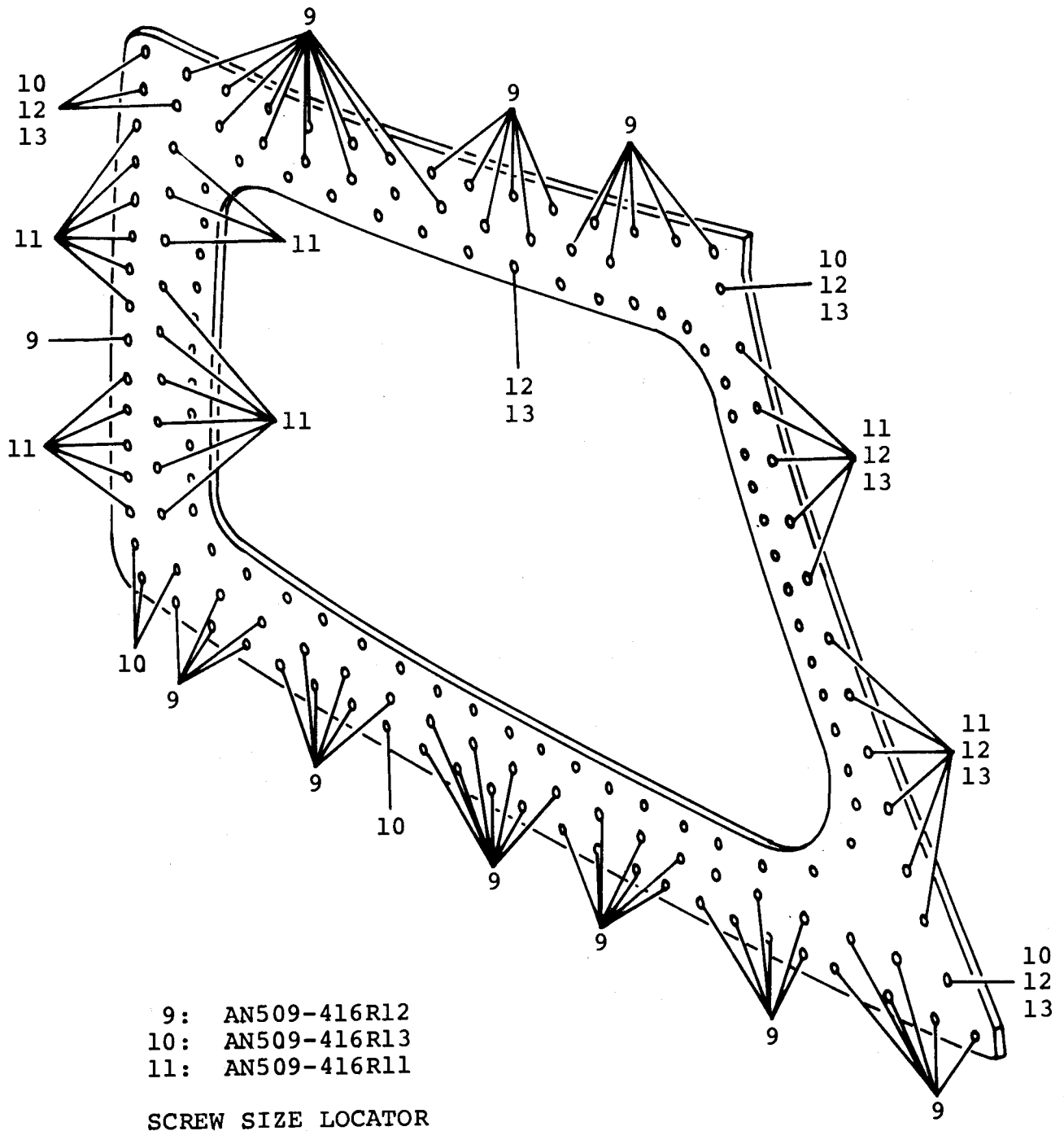
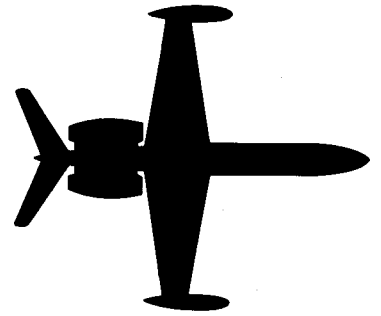

FIGURE 2



# SERVICE INFORMATION LETTER

---

---

SERVICE INFORMATION LETTER NO. 1124-56-081

June 15, 1990

**SUBJECT:** WINDOWS - COCKPIT SIDE WINDOWS

**EFFECTIVITY:** MODEL 1124/1124A WESTWIND, all serial numbers.

**A. REASON**

To alert owners/operators and Service Centers of cockpit side windows P/N 343017-75/51 and P/N 343003-4/51 that have been manufactured without the approval of Israel Aircraft Industries Ltd. (IAI) or Astra Jet Corporation (AJC).

**B. REFERENCE**

1124/1124A Westwind Maintenance Manual, Temporary Revision 56-1.

**C. PUBLICATIONS AFFECTED**

**None**

**D. DESCRIPTION**

A Westwind cockpit side window was received by a Service Center that could not be identified as an IAI/AJC approved part. The Service Center contacted AJC and after investigation it was confirmed that it was a bogus part.

Owners/operators and Service Centers should beware of parts that are not approved by IAI or AJC and tagged accordingly.

Our part numbering system strictly follows our drawings and is easily identified.

Contact AJC - Technical Services, Wilmington, DE at (302) 322-7240 if the validity of a part is in question, to ensure the continued airworthiness of the aircraft.

June 15, 1990

SIL NO. 1124-56-081

Page 1 of 1

# 1124-WESTWIND

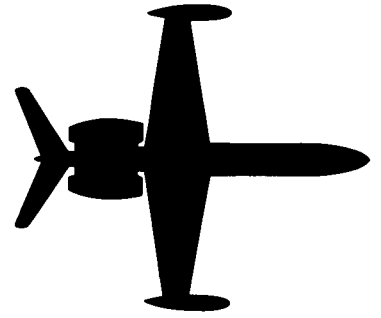

## SERVICE INFORMATION LETTER

---

---

SIL NO. 1124-71-071

April 4, 1988

SUBJECT: EXHAUST - ENGINE TAIL PIPE CLAMP - TORQUE CHECK

EFFECTIVITY: MODEL 1124/1124A WESTWIND, all serial numbers

A. REASON

To caution operators against overtorquing the F10A-5-SCP201-3 tail pipe clamp.

B. REFERENCES

1124/1124A Maintenance Manual, Chapter 71-00-01 page 238.

C. PUBLICATIONS AFFECTED

NONE

D. DESCRIPTION

Failures of the subject clamp have been reported and have been attributed to overtorquing of the V-band clamps during installation. Cracks in the trunnion area can result. This cracking may lead to loosening of the clamp and possible loss of the tail pipe.

The procedures in the 1124/1124A maintenance manual should be carefully adhered to during installation of the tail pipe. The correct torque of 45 in-lbs is engraved on the clamp flange.

SIL 1124-71-071



SUBSIDIARY OF ISRAEL AIRCRAFT INDUSTRIES, LTD.  
BEN GURION AIRPORT, ISRAEL

# SERVICE PUBLICATIONS revision notice

---

OPTIONAL

SIL NO. 1124-73-018  
Revision No.1

June 14, 1985

SUBJECT: ENGINE FUEL COMPUTER EMI FILTER INSPECTION.

REASON FOR

REVISION: To change the Chapter number of SIL.

SIL NO. 1124-28-018 should be changed to read  
SIL NO. 1124-73-018 on all pages.

SB 1124-73-018  
Page 1 of 1



SUBSIDIARY OF ISRAEL AIRCRAFT INDUSTRIES. LTD  
BEN GURION AIRPORT, ISRAEL

# 1124-WESTWIND

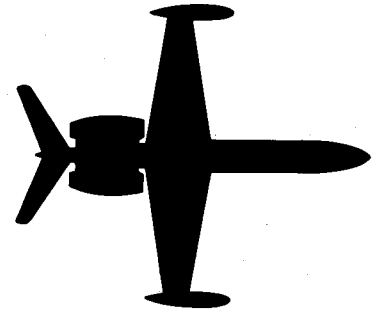

## SERVICE INFORMATION LETTER

---

---

SIL NO. 1124-28-018

January 24, 1985

SUBJECT: ENGINE FUEL COMPUTER EMI FILTER INSPECTION.

EFFECTIVITY: MODEL 1124/1124A, all serial numbers.

### A. REASON

1. To prevent inadvertent Fuel Computer Manual Mode operation should filters become open or installed improperly.
2. To ensure proper procedures for installation of EMI filters.
3. To introduce an inspection procedure to identify suspected defective filters.

### B. PUBLICATIONS AFFECTED

1124/1124A Wiring Manual, Chapter 28-20-01.  
1124/1124A Maintenance Manual, Chapter 78-30-00.

### C. DESCRIPTION

1. It has been found that some EMI filters have been installed incorrectly and/or damaged during installation. It is suggested that the filters be inspected accordingly.
  - (a) Filter mounting holes should be cleaned and polished to ensure a good electrical bond. Apply Iridite 14-2 or Penetrox to prevent corrosion.



SUBSIDIARY OF ISRAEL AIRCRAFT INDUSTRIES, LTD.  
BEN GURION AIRPORT, ISRAEL

SIL 1124-28-018  
Page 1 of 6

2. Filters should be inspected for a cracked hermetic seal due to over torque of nut and/or excessive heat from soldering.
  - (a) Recommended mounting nut torque is sixty (60) inch-ounces maximum.
  - (b) When soldering wires to filter terminals a heat sink should be used to prevent damage to filter studs.
  - (c) A cracked hermetic seal may be found, with the aid of a magnifying glass, by visual inspection at the ceramic insert bond to the filter case.
    - (1) Use of dry ice or a "freeze mist" spray will show a dark area, as the frost evaporates, where a crack may be suspected as the moisture is drawn into the filter case.
    - (2) Most filter failures are caused by this moisture contamination, which permits corrosion of the internal components.
  - (d) Inspect all filter solder connections for cold solder joints and/or frayed wires.
3. An electrical inspection may be performed by freezing the filter, as above, while drawing a 5 amp load from a 28 VDC source through the filter.
  - (a) The filter should exhibit no voltage drop across the filter when under load.
  - (b) The load may be simulated by a 5 to 10 ohm resistor, of 150 watts or greater dissipation, or a combination of 28 volt lamp bulbs in parallel to approximate the load required.
4. Filters should be inspected for proper orientation to ensure they will operate per design function. Note the electrical difference between the type 9010 and type 1020 (or equivalent) filters by reference to Notes in Figure 1 and Figure 2. The type 9010 filters have the capacitor at the threaded end, where the type 1020 (or equivalent) has the capacitor at the button end.
  - (a) Aircraft S/N 154 and 181 through 192 including those in compliance with SL WW-2412.

- (1) WW-2412 dated September 26, 1977 was issued to install two type 1020 filters (alternate Part Number 51-379-000) in the Fuel Computer "Manual Mode" switching circuit to prevent the system from reverting to Manual Mode with electrical interference from some sources.
  - (2) All 6 filters are mounted on brackets at Fuselage Station bulkhead 419.84, near the top of aircraft. Remove aft baggage compartment forward panels to gain access.
  - (3) Verify that the filters are installed in the proper direction by reference to Figure 1 and/or Figure 2, correct as necessary.
- (b) Aircraft S/N 193 through 258, including those in compliance with SL WW-2412.
- (1) See paragraph C.4.(a).(1). above.
  - (2) All 6 filters are mounted at Fuselage Station bulkhead 452.0, near top of aircraft. Remove aft baggage compartment aft panels to gain access.
  - (3) Verify that the filters are installed in the proper direction by reference to Figure 1 and/or Figure 2, correct as necessary.
- (c) Aircraft S/N 259 and subs:
- (1) The filters for both Fuel Computers are located in a box at Fuselage Station 473, attached to a cross member above aft baggage compartment. Remove aft overhead panels to gain access.
  - (2) Verify that the filters are installed in the proper direction by reference to Figure 3, correct as necessary.
  - (3) When reinstalling filter box, ensure that all attaching surfaces are clean and bonded as in Paragraph C.1.a.
5. Identify the existing Wiring Diagram Manual filter drawing as the Part Number 1020-000 type, and add a sketch showing the Part Number 9010-100-0013 filter as shown in Figure 1. Reference Wiring Diagram Manual Chapter 28-20-01 for your aircraft.



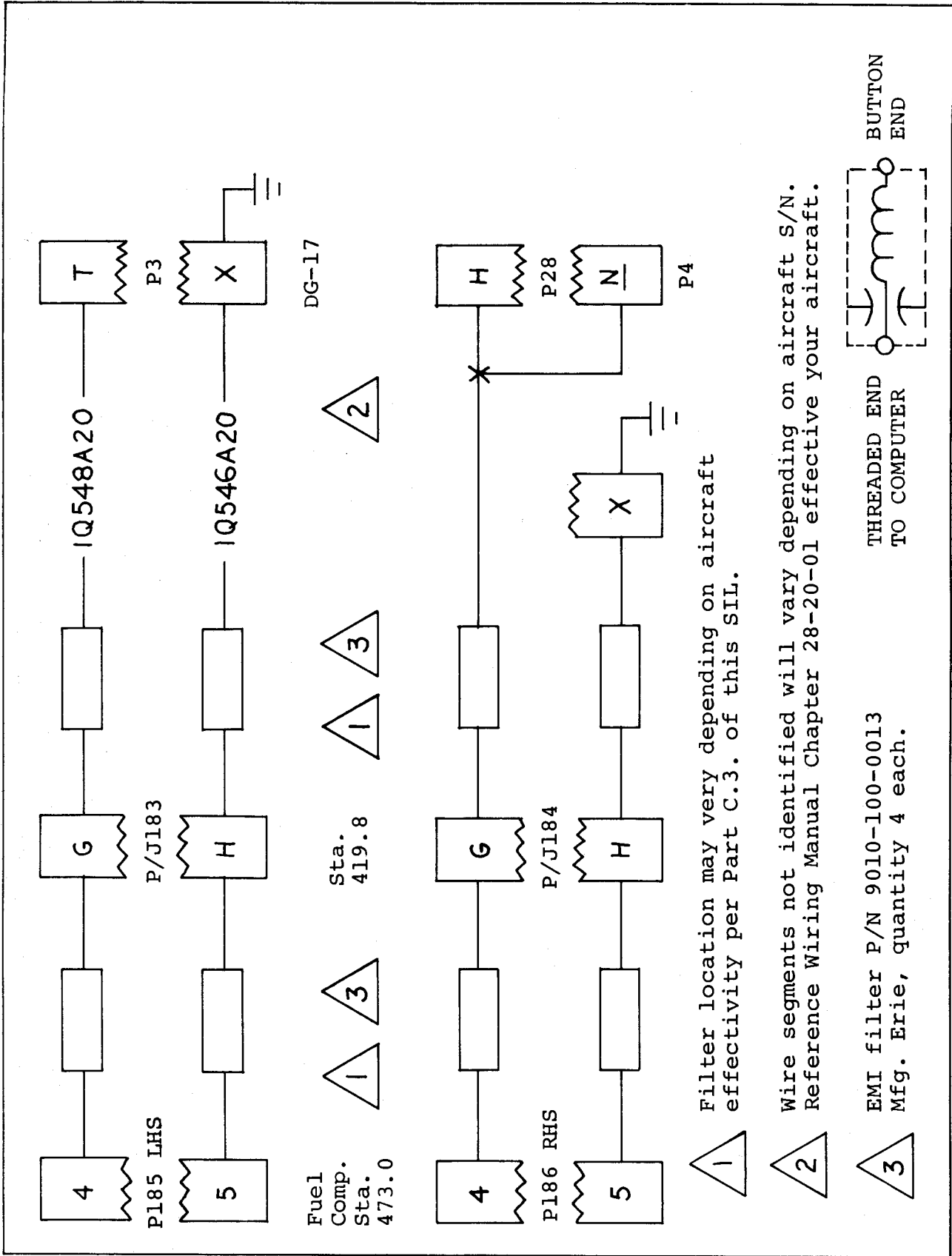

FIGURE 1

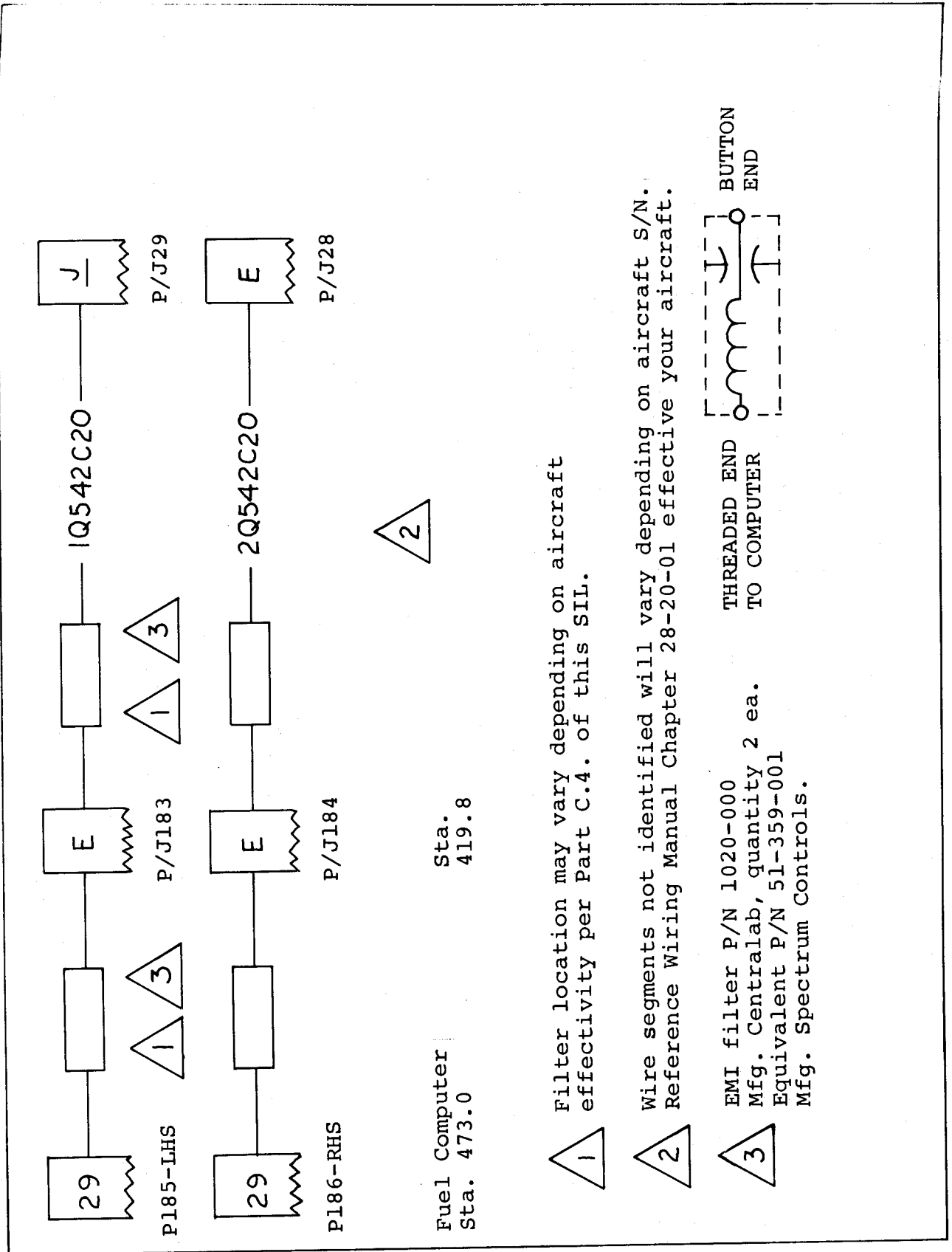

FIGURE 2

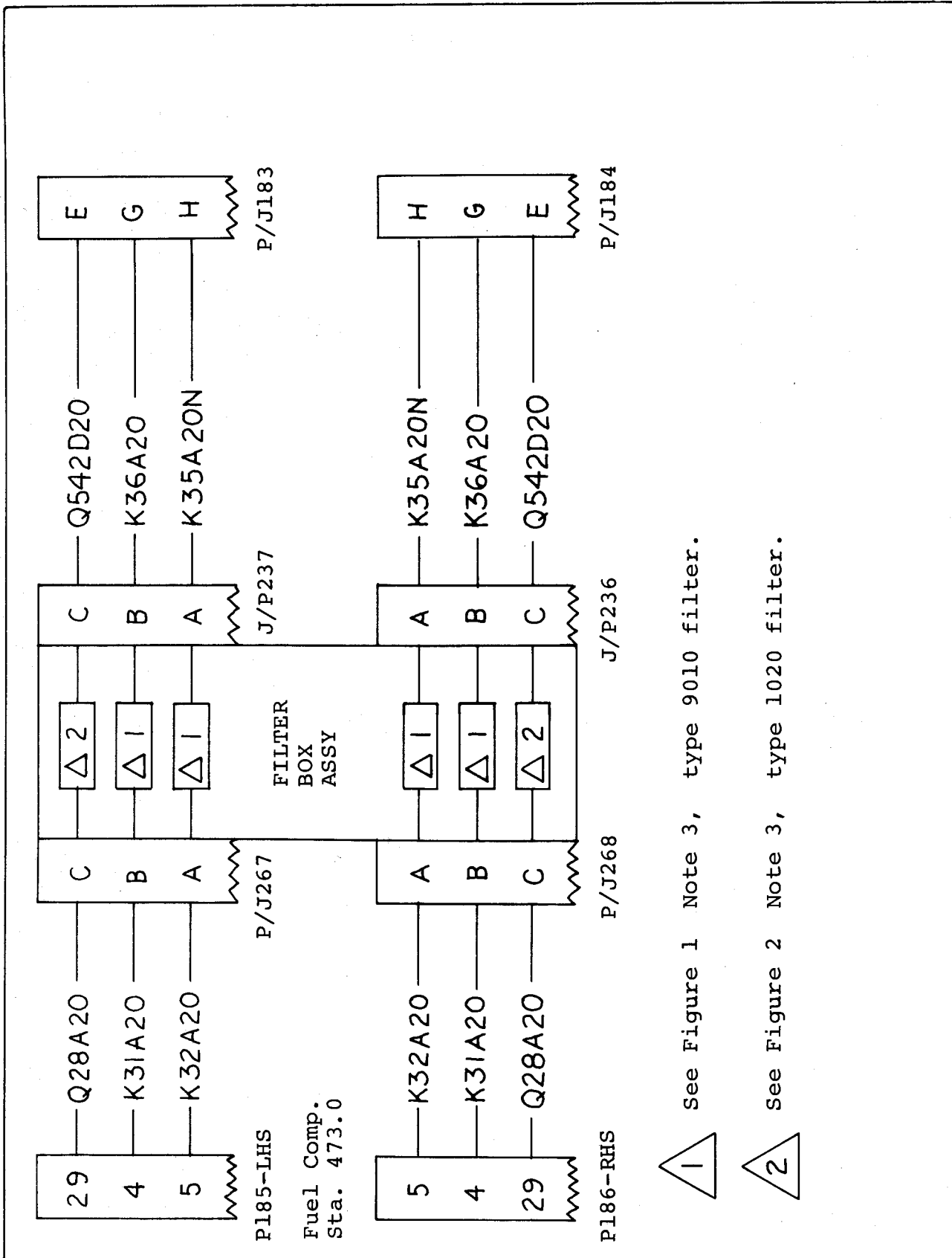
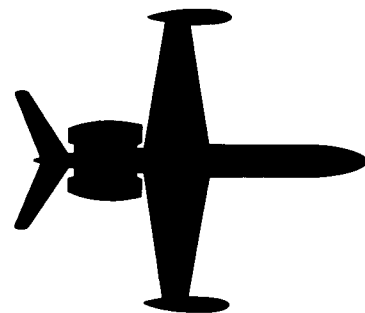

FIGURE 3

# 1124-WESTWIND



## SERVICE INFORMATION LETTER

---

---

SIL NO. 1124-76-024

February 26, 1985

SUBJECT: IDENTIFICATION OF THROTTLE QUADRANT LIMIT SWITCH  
ASSIGNMENTS.

EFFECTIVITY: MODEL 1124/1124A WESTWINDS, serial numbers 187  
through 408.

A. REASON

To correctly identify throttle quadrant limit switch assignments according to latest changes through serial number 408.

B. REFERENCES

CMA 4813642 Landing Gear Control drawing supplied with your aircraft.

C. PUBLICATIONS AFFECTED

Information contained in this SIL will be included in the next scheduled revision to the 1124/1124A Maintenance Manual.

D. DESCRIPTION

Refer to Table 1 for switch assignments for serial numbers 187 through 408.

<u>SWITCH NO.</u>	<u>ASSIGNMENT</u>	<u>AIRCRAFT S/N</u>
1-4	Thrust Reverser Piggyback Switches	All
5	L.H. Ignition Cut-Out	All
6	R.H. Ignition Cut-Out	All



SUBSIDIARY OF ISRAEL AIRCRAFT INDUSTRIES, LTD.  
BEN GURION AIRPORT, ISRAEL

SIL 1124-76-024  
Page 1 of 2

SERVICE INFORMATION LETTER NO. 1124-76-024

<u>SWITCH NO.</u>	<u>ASSIGNMENT</u>	<u>AIRCRAFT S/N</u>
7	L.H. Landing Gear Warning	All except: 314, 316, 317, 325,
8	R.H. Landing Gear Warning	366, 371, 381, 386, 388, 408.
9	L.H. Lift Dump	All
10	R.H. Lift Dump	
111	L.H. ECS Cutoff	187 thru 215 except: 206, 208, 211, 213, 214.
12	RH ECS Cutoff	All
13	L.H. ECS (Special Usage)	216 only
14	R.H. Landing Gear Warning L.H. Landing Gear Warning	314, 316, 317, 325, 366, 371, 381, 386, 388, 408.
11	L.H. Hi-Limit (SCAT & AUTO) Throttle	374 only
13	L.H. Lo-Limit (SCAT & AUTO) Throttle	374 only
14	R.H. Lo-Limit (SCAT & AUTO) Throttle	374 only
16	R.H. Hi-Limit (SCAT & AUTO) Throttle	374 only

END

TABLE 1

# **1124-WESTWIND**

## **SERVICE INFORMATION LETTER**

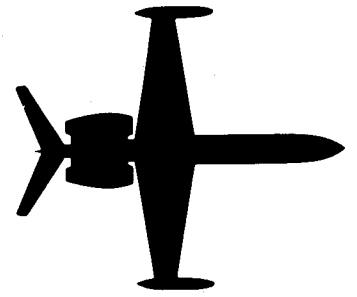

### **SERVICE INFORMATION LETTER INDEX**

<b>NO.</b>	<b>DATE</b>	<b>SUBJECT</b>
01A	Nov 30/82	Service Information Letter
02	Nov 7/80	High Pressure Bleed Port Gasket
03	CANCELLED	
04	Dec 4/80	Generator Control Wires 1P16B and 1P17B on Left Engine and 2P16B and 2P17B on Right Engine
05	Dec 4/80	Nose Wheel Steering System
06	Jun 12/81	ADF 60 Accuracy, 1124 Westwind Series
07	CANCELLED Sep 8/89	AP105/APS80 Capstan Tension Tests, 1123, 1124, and 1124A Westwind Series Aircraft
08	Jun 12/81	Manual VOR/RNAV Select, 1124 Westwind Series
09	Jun 12/81	Reduction of Pitch Bumps, 1124 Westwind Series
10 Rev. No. 2	Jun 20/85	Ledex Rotary Solinoid Failure
11	Jan 13/82	Cold Weather Tire Precautions
12	Mar 1/82	Airesearch Service Information Letter No. 21-L-526
13 Rev. No. 1	Nov 12/84	Rockwell-Collins WXR300 Radar System Dessicant Replacement
14	Mar 1/82	Airesearch Service Information Letter No. 21-L-522

## SERVICE INFORMATION LETTER INDEX

<u>NO.</u>	<u>DATE</u>	<u>SUBJECT</u>
15	Mar 1/82	1124 Time Limit Changes
16	Mar 1/82	Lear Siegler Starter/Generator Brush Inspection
17	Mar 1/82	1124 Westwind Fuel Management Procedure
18 Rev. No. 1	Jul 30/82	Flap System Flex Shaft Pin Replacement
19	May 1/82	Application Instructions for Skin Temperature Sensor
20B	Mar 20/85	Intertechnique Fuel Boost Pumps, P/N 5653744-1, -501 and -503 Brush Inspection
21	Aug 31/82	NCS31A Read Out Problems
22	Aug 31/82	Sperry GH14A/B Attitude Gyro Installations
23 Rev.	Nov 30/82	Intercom System Audio Clarity
24	Sep 7/82	Microphone System Update
25	Sep 7/82	Aft Baggage Compartment Mic Wiring Conformity Check
26	Sep 7/82	#1 or #2 Compass System - DG Switch Modification
27	Nov 30/82	Upper and Lower NLG Bearing Precautions
28	Nov 30/82	Learavia Battery Temp System Tests, 1124/1124A Westwinds
29	Nov 30/82	Wing Root Lower Access Panel Attachment Check
30	Feb 28/83	Use of BIOBOR JF Fuel Additive
31A	Jul 15/83	Replacement of Brake Assembly to Axle Mounting Bolts
32	Mar 31/83	Replacement of P/N 572375-3 Cooling Turbine with P/N 572375-2 Cooling Turbine
33	Mar 31/83	Engine Cross Start

**SERVICE INFORMATION LETTER INDEX**

<b><u>NO.</u></b>	<b><u>DATE</u></b>	<b><u>SUBJECT</u></b>
34	Apr 15/83	Intermittent Collins Rack Mount Connectors
35	CANCELLED May 22/87	Vibration Level for #2 Altimeter
36	May 16/83	1124 Westwind Refrigeration Unit Installaltion
37	Jul 1/83	Emergency Exit Checks
38	Nov 30/83	Inspection and Service Life on Gas Storage Bottles P/N 3753015 and 3753015-501



# 24-WESTWIND

## SERVICE INFORMATION LETTER

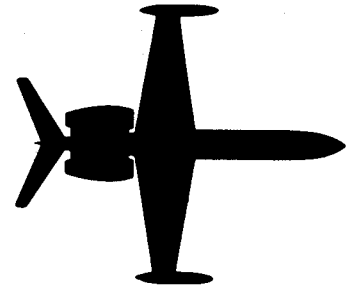

S I L No. 01A

November 30, 1982

(This Service Information Letter supercedes SIL No. 01, dated November 7, 1980 in its entirety.)

The Service Information Letter is an official publication of IAI/IAII and is a part of the Service Data Book. SIL's should be retained as a permanent reference document.

Service Information Letters will transmit data of an informative nature only and should not be interpreted as data approved by ICAA/FAA or IAI Engineering. SIL's will advise operators of maintenance hints, verifications of system configuration, announce approved changes in advance of formal publication and transmit some vendor data.

Page 1 of 1



SUBSIDIARY OF ISRAEL AIRCRAFT INDUSTRIES. LTD.  
BEN GURION AIRPORT, ISRAEL

# 24-WESTWIND

## SERVICE INFORMATION LETTER

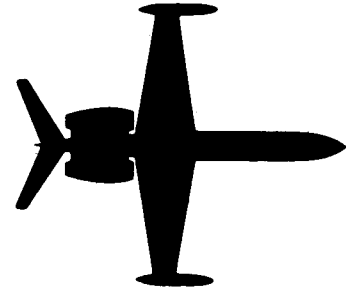

SIL No. 02

NOVEMBER 7, 1980

SUBJECT: HIGH PRESSURE BLEED PORT GASKET

Investigation of a reported ITT overlimit revealed high pressure bleed air leakage at the engine high pressure bleed port.

The leakage resulted from deterioration of a P/N 3071117 gasket. This gasket is an AiResearch shipping gasket and is not suitable for extended inservice use.

When an engine is returned from an AiResearch repair facility for reinstallation, or a Loaner Engine is installed, the shipping gasket should be removed and a gasket P/N F10A-5-P20244-15 installed on the high pressure bleed port.

Reference 1124 IPC, Chapter 71-00-00, Figure 5, Item 33

Page 1 of 1



SUBSIDIARY OF ISRAEL AIRCRAFT INDUSTRIES, LTD.  
BEN GURION AIRPORT, ISRAEL

# **24-WESTWIND**

## **SERVICE INFORMATION LETTER**

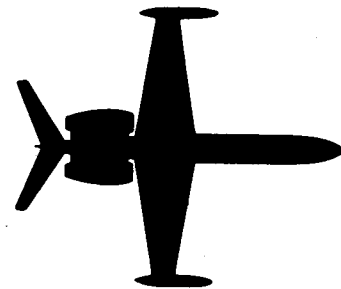

S I L No. 04

December 4, 1980

**SUBJECT: GENERATOR CONTROL WIRES 1P16B AND 1P17B ON LEFT  
ENGINE AND 2P16B AND 2P17B ON RIGHT ENGINE**

A recent inflight generator loss was attributed to control wires chafing on nacelle door frame.

Figures 1 and 2 depict the proper routing of the generator control wires along bottom of engine to the generator terminals.

The generator control wiring should be routed along and secured at the following points, (See Figures 1 and 2).

- 1) Wires attached to Oil Press. Transmitter bracket.
- 2) Wires attached to Engine Gang Drain bracket.
- 3) Wires attached to accessory gear box Attenuator mount pad.
- 4) Wires attached to Structural Brace with "Tie-Strap".

This routing should maintain proper clearance of wires from nacelle door frames.



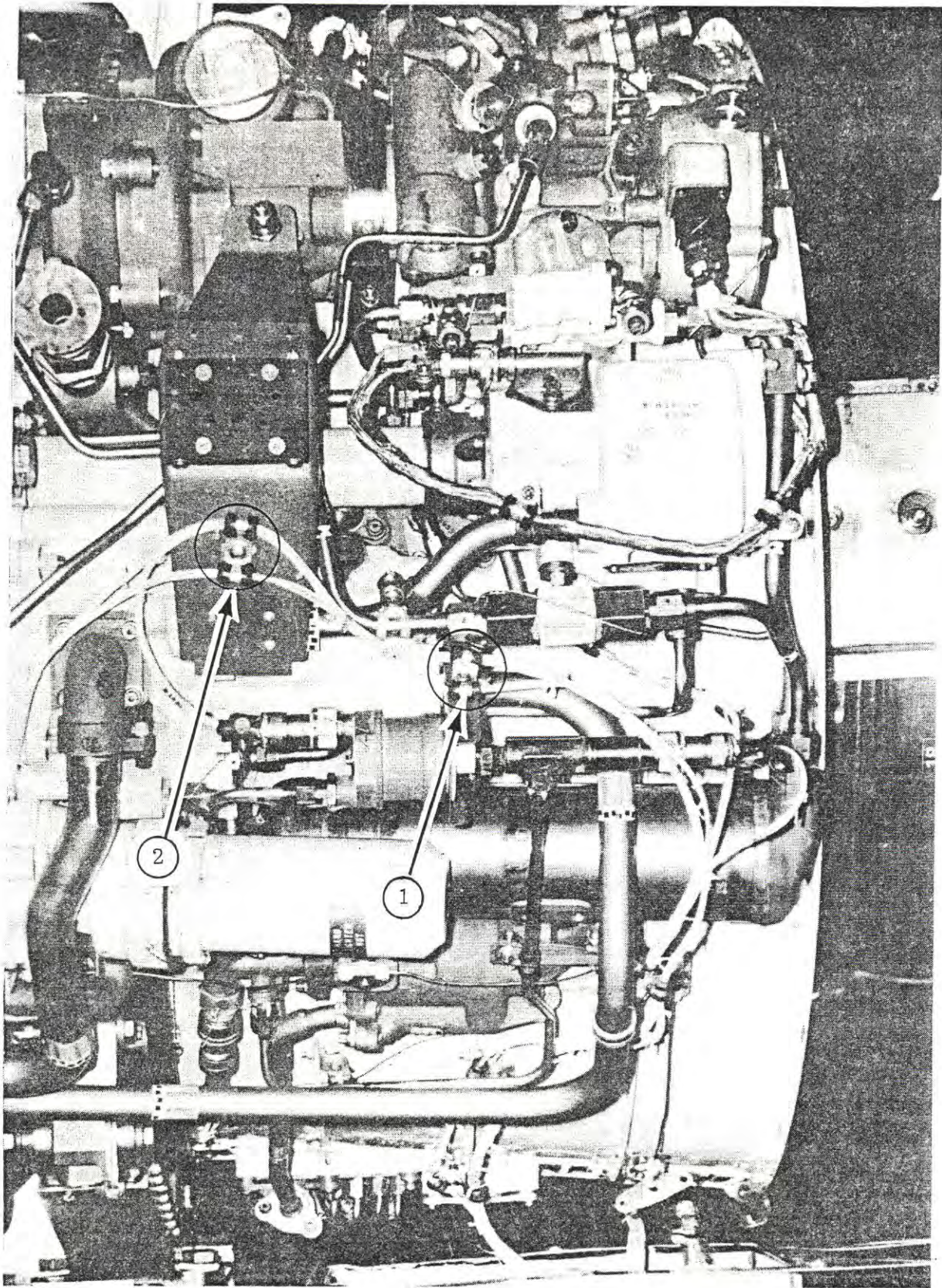

FIGURE 1



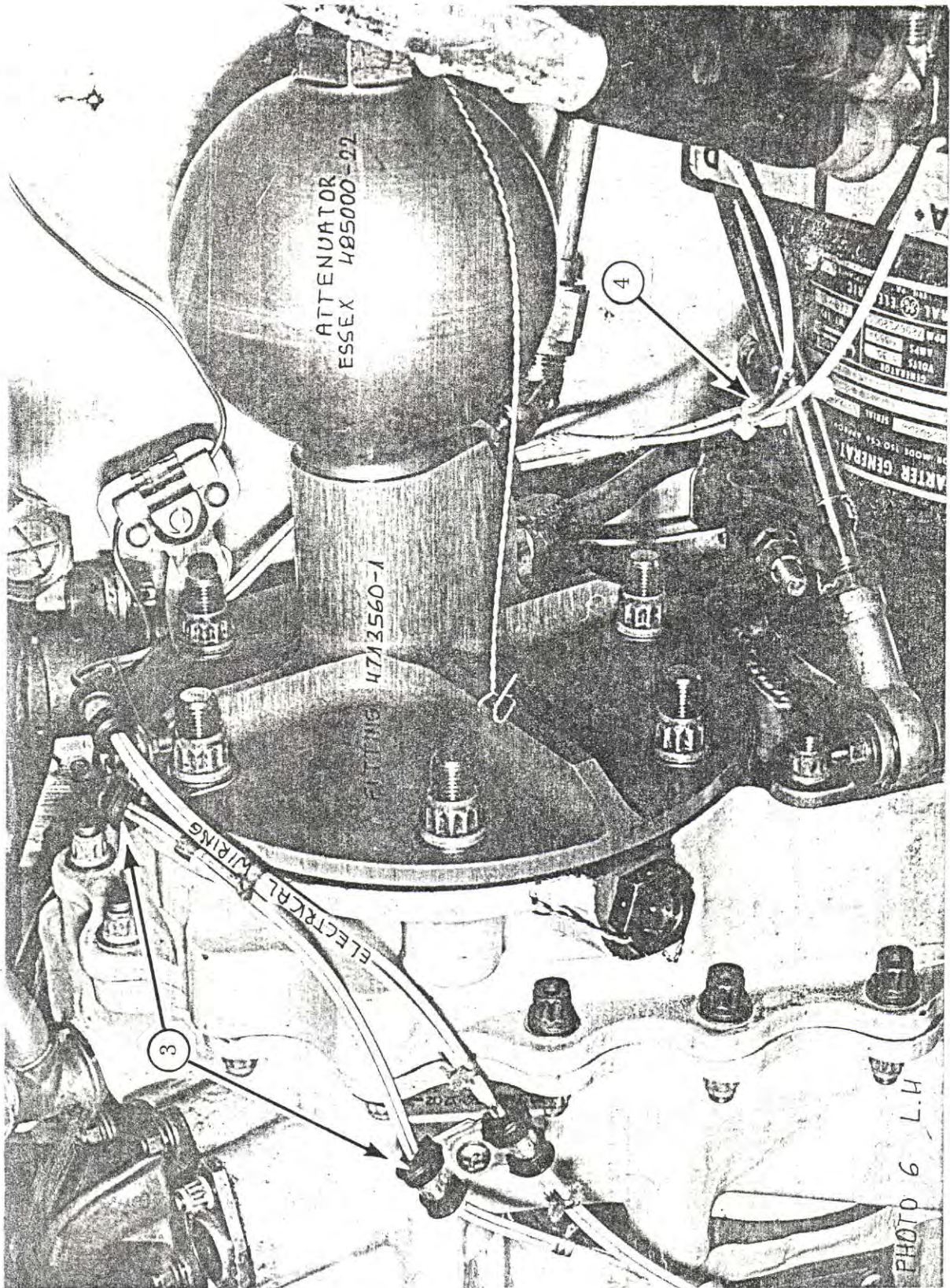
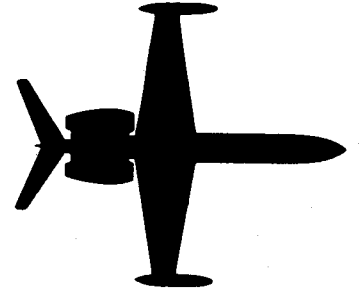

FIGURE 2

# **24-WESTWIND**

## **SERVICE INFORMATION LETTER**



S I L No. 05

December 4, 1980

**SUBJECT: NOSE WHEEL STEERING SYSTEM**

Investigation of reported "POPPING" noises coming from nose gear during ground taxi, revealed popping sounds were coming from nose steering brackets at radar bulkhead attach points, reference Figure 3, Chapter 35-50-00, 1124 IPC.

The attaching bolts (4 ea. AN4-10A) were not torqued down properly. Refer to Chapter 12-00-00, Page 10, 1124 Maintenance Manual for proper torque value for AN4 size bolts with MS20365 type nuts, also assure adequate washers are installed to prevent nuts from bottoming out on bolt shank.



SUBSIDIARY OF ISRAEL AIRCRAFT INDUSTRIES, LTD.  
BEN GURION AIRPORT, ISRAEL

Page 1 of 1

# 24-WESTWIND

## SERVICE INFORMATION LETTER

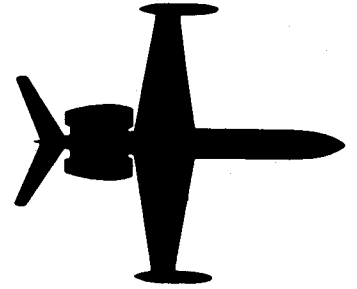

S I L No. 06

June 12, 1981

SUBJECT: ADF 60 ACCURACY, 1124 WESTWIND SERIES

To provide greater ADF accuracy, those aircraft equipped with ADF 60 systems may wish to change the Quadrantal Error correction from  $19^{\circ}$  to  $14^{\circ}$ . This can be accomplished by removing the jumper between pins 4 and 20, and adding two new jumpers; one between pins 4 and 12, and the other between pins 16 and 20.

The procedure described above applies only to the No. 1 ADF 60 in those aircraft with dual systems.

Page 1 of 1



**IAI** INTERNATIONAL INC.  
ISRAEL AIRCRAFT INDUSTRIES INTERNATIONAL INC

SUBSIDIARY OF ISRAEL AIRCRAFT INDUSTRIES, LTD.  
BEN GURION AIRPORT, ISRAEL



# **24-WESTWIND**

## **SERVICE INFORMATION LETTER**

---

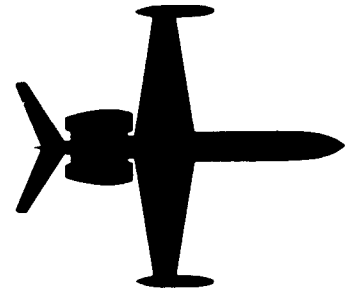

SERVICE INFORMATION LETTER NO. 07

September 8, 1989

SUBJECT: AP105/APS80 CAPSTAN TENSION TESTS, 1123, 1124 1124A  
WESTWIND SERIES AIRCRAFT

### CANCELLATION NOTICE

This service information letter is hereby cancelled. The information contained in this service information letter has been revised and reissued in Service Information Letter No. 1124-22-068.

June 12, 1981  
Revision 1, October 15, 1982  
Revision 2, September 8, 1989

SIL No. 07  
Page 1 of 1



# 24-WESTWIND

## SERVICE INFORMATION LETTER

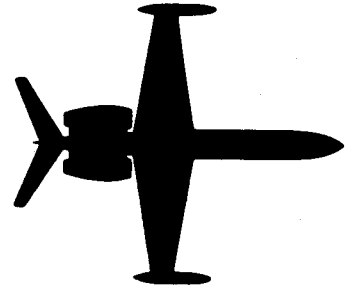

S I L No. 07

June 12, 1981  
Revised October 15, 1982

SUBJECT: AP105/APS80 CAPSTAN TENSION TESTS, 1123, 1124 AND 1124A  
WESTWIND SERIES AIRCRAFT.

A lot of poor, sloppy auto-pilot control has been traced to the servo mount capstan slipping. This condition can be ground tested as follows:

Using external power, inverters on, allow gyros to erect and engage A/P-YD. Neutralize system (no flight director modes) with pitch/roll command knobs, with control yoke, wheel, and rudder pedals in center of travel.

Operate control wheel, once, rapidly, to left or right stop and immediately release. Wheel should overshoot once and return to center. No response, or very slow response would indicate a "soft" capstan.

Neutralize system, repeat for pitch and yaw. Should this check indicate a soft capstan, contact your Collins Field Service Engineer for corrective action. It will be necessary to remove the servo, and disassemble the servo mount/capstan from the aircraft to readjust the system.

NOTE: Do not cycle controls "back and forth" prior to release for test. This creates an artificial condition that looks like a proper response.

Page 1 of 1



SUBSIDIARY OF ISRAEL AIRCRAFT INDUSTRIES LTD.  
BEN GURION AIRPORT, ISRAEL

# **24-WESTWIND**

## **SERVICE INFORMATION LETTER**

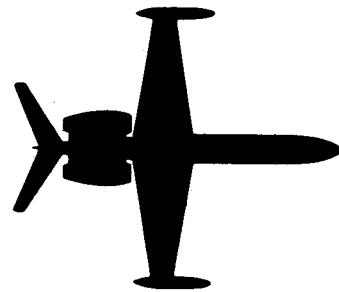

S I L No. 08

June 12, 1981

**SUBJECT: MANUAL VOR/RNAV SELECT, 1124 WESTWIND SERIES**

In response to requests to provide a method of manual select/deselect of RNAV information on the HSI, to provide RNAV PRU ground speed while navigating in STD VOR/DME mode, the following suggestion is provided.

Reference Chapter 34-50-13 and 34-50-02, Westwind Wiring Manual. For aircraft S/N 239 and prior, identify terminal strip T36-16, and cut jumper between T36-6 and T36-16. Ensure that T36-6 is a hard ground and that T36-16 grounds when the "VOR ONLY" switch is depressed, the ground must be removed when "VOR ONLY" is depressed the second time. Wire RP59A and RP59B should exist on T36-16.

For aircraft S/N 240 and subs, it may be necessary to add a ground wire from S5D-7 (VOR ONLY) to airframe, and a wire from S5D-5 to wire RP59A. Wire RP59A will have to be removed from terminal strip T4 and spliced to new wire from S5D5 at any convenient empty terminal.

With wire RP59A open (VOR ONLY) depressed, the HSI transfer system will not revert to RNAV, and VLF switch still assumes priority.

Page 1 of 1



SUBSIDIARY OF ISRAEL AIRCRAFT INDUSTRIES, LTD.  
BEN GURION AIRPORT, ISRAEL

# **24-WESTWIND**

## **SERVICE INFORMATION LETTER**

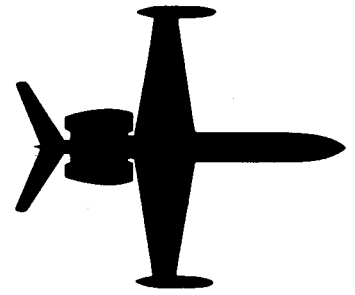

S I L No. 09

June 12, 1981

**SUBJECT: REDUCTION OF PITCH BUMPS, 1124 WESTWIND SERIES**

Complaints of pitch bumps over OM AND MM while in GLIDESLOPE CAPTURE, approach mode with auto-pilot on can be reduced by incorporating Collins Service Bulletin 23 in the 562A5M5 flight computer. Should Collins Service Bulletin 24 be installed in th 562A5M5, remove SB24 and restore to original configuration.

Reference Chapter 34-10-01, pin 43 of radio altimeter (B70) should go to T33-15 (A/C S/N 239 and prior) or T34-15 (A/C S/N 240 and subs) on wire SA16A20. If pin 24 (wire SA11A10) is used, change wire on terminal strip to allow use of 500 foot trip for smoother approaches.

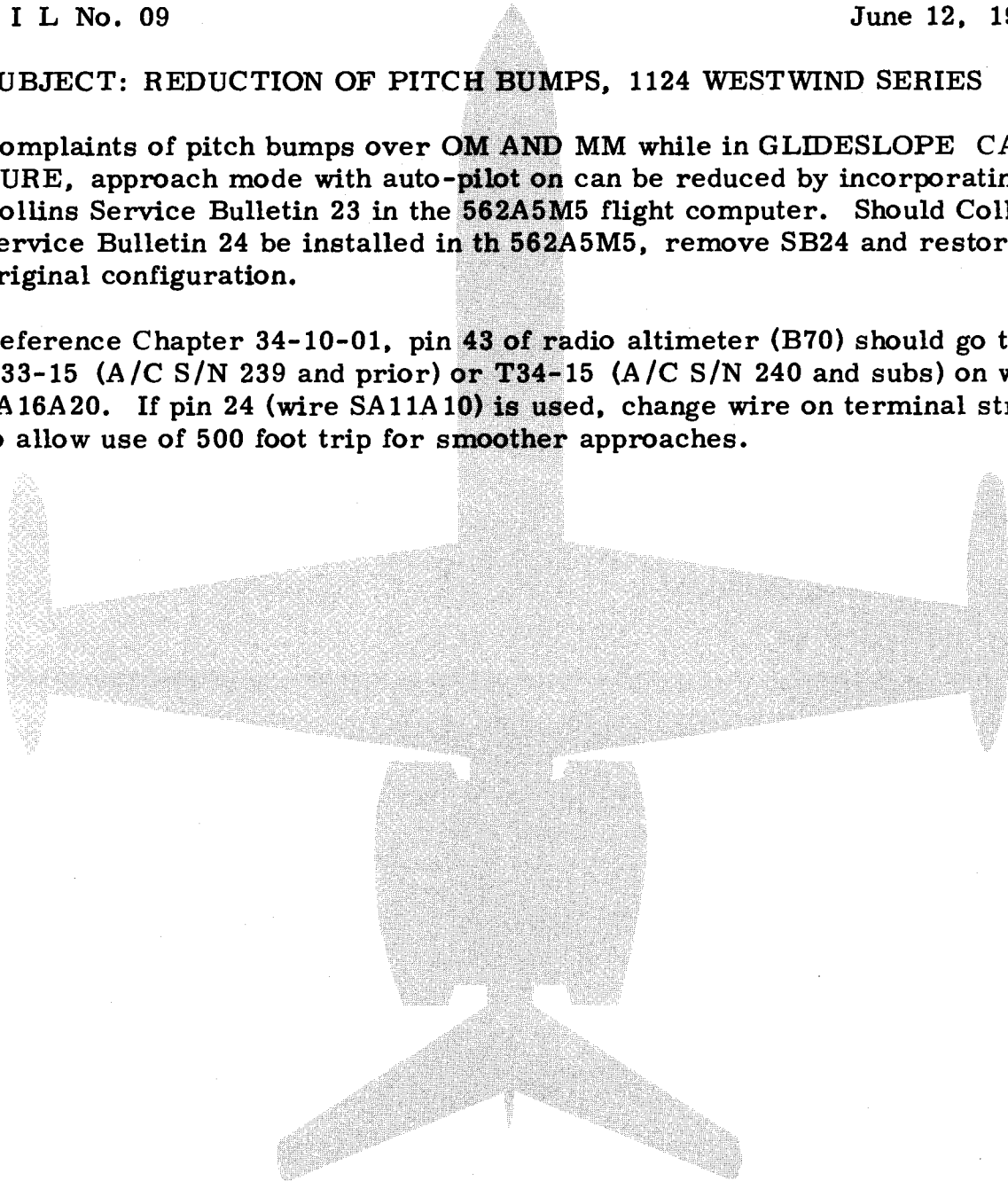

Page 1 of 1



SUBSIDIARY OF ISRAEL AIRCRAFT INDUSTRIES, LTD.  
BEN GURION AIRPORT, ISRAEL

# SERVICE PUBLICATIONS revision notice

---

SIL NO. 10 (Revision 2)

June 20, 1985

SUBJECT: LEDEX ROTARY SOLENOID FAILURE

REASON FOR

REVISION: To add a suitable substitute to P/N 187408-001.

After P/N 187408-001 add the word "or" and  
P/N 189151-001.

Page 1 of 1



INTERNATIONAL INC.  
ISRAEL AIRCRAFT INDUSTRIES INTERNATIONAL INC.  
SUBSIDIARY OF ISRAEL AIRCRAFT INDUSTRIES LTD.  
BEN GURION AIRPORT, ISRAEL

# 24-WESTWIND

## SERVICE INFORMATION LETTER

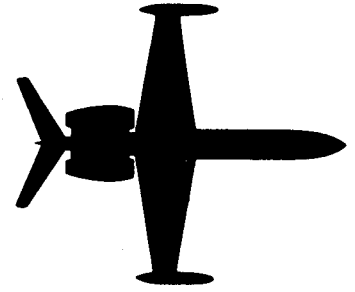

S I L No. 10

June 12, 1981

**SUBJECT: LEDEX ROTARY SOLENOID FAILURE**

To reduce the incidence of solenoid electrical failures, which is generally caused by failure or improper wiring of the Arc Suppression Diodes, the system should be checked as follows: (Use a Simpson 260 VOM or equiv.)

Locate the identification placard on the solenoid in question and identify the solenoid P/N. Refer to chart below for pins to be used in testing.

<u>A</u>	<u>B</u>	<u>C</u>	<u>D</u>	<u>E</u>
<u>SOLENOID P/N</u>	<u>SUPPRESSOR RED DOT</u>	<u>INTERNAL COMMONS</u>	<u>AIRFRAME GROUND</u>	<u>SUPPRESSOR COMMON</u>
175096-001	J1-43	J1-44, 45		
172934-001	J2-q	J2-m	J2-m	J2-m
172935-001	J1-f	J1-j	J1-j	J1-j
172936-001	J1-DD	J1-CC	J1-CC	J1-CC
172962-001	J1-42	J1-43, 44		
172963-001	J1-50	J1-54, 55		
172964-001	J1-42	J1-43, 44		

For those units using two pins for internal common, check both pins for airframe ground, (using Ohms X1 scale), whichever is grounded note in column D above. The ungrounded pin is suppressor common, enter pin number in column E above.

Using Ohms X10 scale, measure between column B and column E pins. You should see an open or a short, depending on meter lead polarity. Reverse the leads and the measured condition should also reverse, as we are looking for a diode across these pins.

Should you continue to read "open" in both directions, the suppressor is bad, or not wired properly. Reference Chapter 34-50-02 and 34-50-04 for your aircraft. Should a problem exist, replace the suppressor P/N 126911-004 or 122654-001, and ensure the red dot goes to pin shown in column B.

Information for repair of defective units may be obtained from Ledex, Inc. Telephone 513-898-3621.



INTERNATIONAL INC.  
ISRAEL AIRCRAFT INDUSTRIES INTERNATIONAL INC.  
SUBSIDIARY OF ISRAEL AIRCRAFT INDUSTRIES LTD.  
BEN GURION AIRPORT, ISRAEL

SIL NO. 10 (Revision 1)

November 16, 1984

(This Service Information Letter supercedes SIL NO. 10 dated June 12, 1981 in its entirety.)

SUBJECT: LEDEX ROTARY SOLENOID FAILURE

To reduce the incidence of solenoid electrical failures, which is generally caused by failure or improper wiring of the Arc Suppression Diodes. The system should be checked as follows using a Simpson 260 VOM (or equiv.).

Locate the identification placard on the solenoid in question and identify the solenoid P/N. Refer to chart below for pins to be used in testing:

<u>A</u> <u>SOLENOID P/N</u>	<u>B</u> <u>SUPPRESSOR</u> <u>RED DOT</u>	<u>C</u> <u>INTERNAL</u> <u>COMMONS</u>	<u>D</u> <u>AIRFRAME</u> <u>GROUND</u>	<u>E</u> <u>SUPPRESSOR</u> <u>COMMON</u>
175096-001	J1-43	J1-44, 45		
172934-001	J2-g	J2-m	J2-m	J2-m
172935-001	J1-f	J1-j	J1-j	J1-j
172936-001	J1-DD	J1-CC	J1-CC	J1-CC
172962-001	J1-42	J1-43, 44		
172963-001	J1-50	J1-54, 55		
172964-001	J1-42	J1-43, 44		
187408-001	J1-49	J1-50, 51	J1-51	J1-50

For those units using two pins for internal common, check both pins for airframe ground (Using Ohms X1 scale). Whichever pin is found to be a "ground" make the appropriate pin number entry under Column D, AIRFRAME GROUND. The ungrounded pin is suppressor common, enter pin number in column E above.

Using Ohms X10 scale, measure between Column B and Column E pins. You should see an open or a short, depending on meter lead polarity. Reserve the leads and the measured conditions should also reverse, as we are looking for a diode across these pins.

Should you continue to read "open" in both directions, the suppressor is bad, or not wired properly. Reference Wiring Manual, Chapter 34-50-02 and 34-50-04. Should a problem exist, replace the suppressor P/N 126911-004 or 122654-001, and ensure the red dot goes to pin shown in Column B.

1124/1124A of new manufacture may have the suppressors wired to the Ledex Solenoid on "pigtailed" at the solenoid itself, rather than on terminal strips as shown in ATA 34-50-02/04.

Information for repair of defective units may be obtained from Ledex, Inc. Telephone (513) 898-3621.

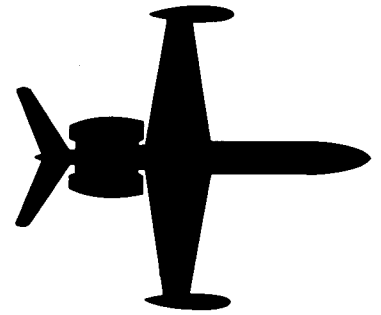

## SERVICE INFORMATION LETTER

---

S I L No. 11

January 13, 1982

SUBJECT: Cold Weather Tire Precautions

With the advent of colder weather, several cases of rapid tire pressure loss have been experienced on the Model 1124 main tires. This has been a reoccurring problem in cold weather operation.

Goodyear Aerospace has extensively tested a wheel and tire which had experienced this rapid pressure loss, but were unable to duplicate the rapid pressure loss. However, leakage was experienced through the wheel O-ring packing during simulated taxi at  $-55^{\circ}\text{F}$ , and a new O-ring packing has been designed which should be available for field testing in early February.

Since it has not been possible to duplicate the rapid tire pressure loss under controlled conditions, we suggest the following precautions be taken when operations are considered into or out of an area where the ambient temperature is below  $10^{\circ}\text{F}$ :

1. Insure that tires and wheels are installed and assembled in accordance with Goodyear Aerospace Manual AP-446 or Chapter 32-40-00 of the Model 1124/1124A Maintenance Manual. Particular attention should be given to inspection of the wheel O-ring packing, adequate greasing of the O-ring prior to installation, liberal application of Lubtork to the wheel assembly bolts, washers and nuts (see Goodyear GS-SL-11), and torquing of the bolts to the proper value.
2. Until new wheel O-ring packings have been tested and made available by Goodyear, it is recommended that MS9021-268 O-rings, manufactured by Parker Seal Co. be used when available. The Parker O-rings have better cold temperature characteristics than some other seals which also meet MS9021-268. The thickness of any new O-ring packing should be checked before installation on the wheel. Minimum thickness is 0.135 inch.

Page 1 of 3



SUBSIDIARY OF ISRAEL AIRCRAFT INDUSTRIES, LTD.  
BEN GURION AIRPORT, ISRAEL



SERVICE INFORMATION LETTER No. 11

3. The allowed leakage rate of a mounted and inflated tire is 5% or approximately 8 psi in 24 hours. Also, tire pressure will fluctuate with temperature. For each 5°F of temperature change the tire pressure will change approximately 1.5 psi. For these reasons, TIRE PRESSURE SHOULD BE CHECKED DAILY. If large temperature changes are to be encountered, then tire pressure should be serviced prior to each flight. When operations are to be made from a moderate temperature to a colder temperature, then tire pressure should be adjusted so that the pressure upon arrival will be approximately 140 psi. Use Figure 1 as a guide to adjust tire pressure to maintain a minimum of 140 psi. After returning to moderate temperatures, tire pressure should be reduced to the recommended pressure of 155 psi.
4. Goodyear recommends a maximum tire pressure of 166 psi be observed, however in some cases it may be necessary to exceed this value to insure adequate tire pressure upon arrival at a destination where very cold ambient temperatures are expected. Be advised that operations with tire pressures in excess of 166 psi will tend to reduce wheel and bolt life, depending on gross weight and taxi distances.
5. If the airplane has set for some time, it is recommended that the airplane be moved off the "flat spots" on the tires before tire pressure is checked.
6. After servicing tires, leak check valve core, then replace high pressure valve stem cap.

If you experience rapid tire pressure loss, please complete the enclosed questionnaire and forward it to IAI International, Oklahoma City, OK. This will help us determine the extent of the problem and will assist in the resolution.

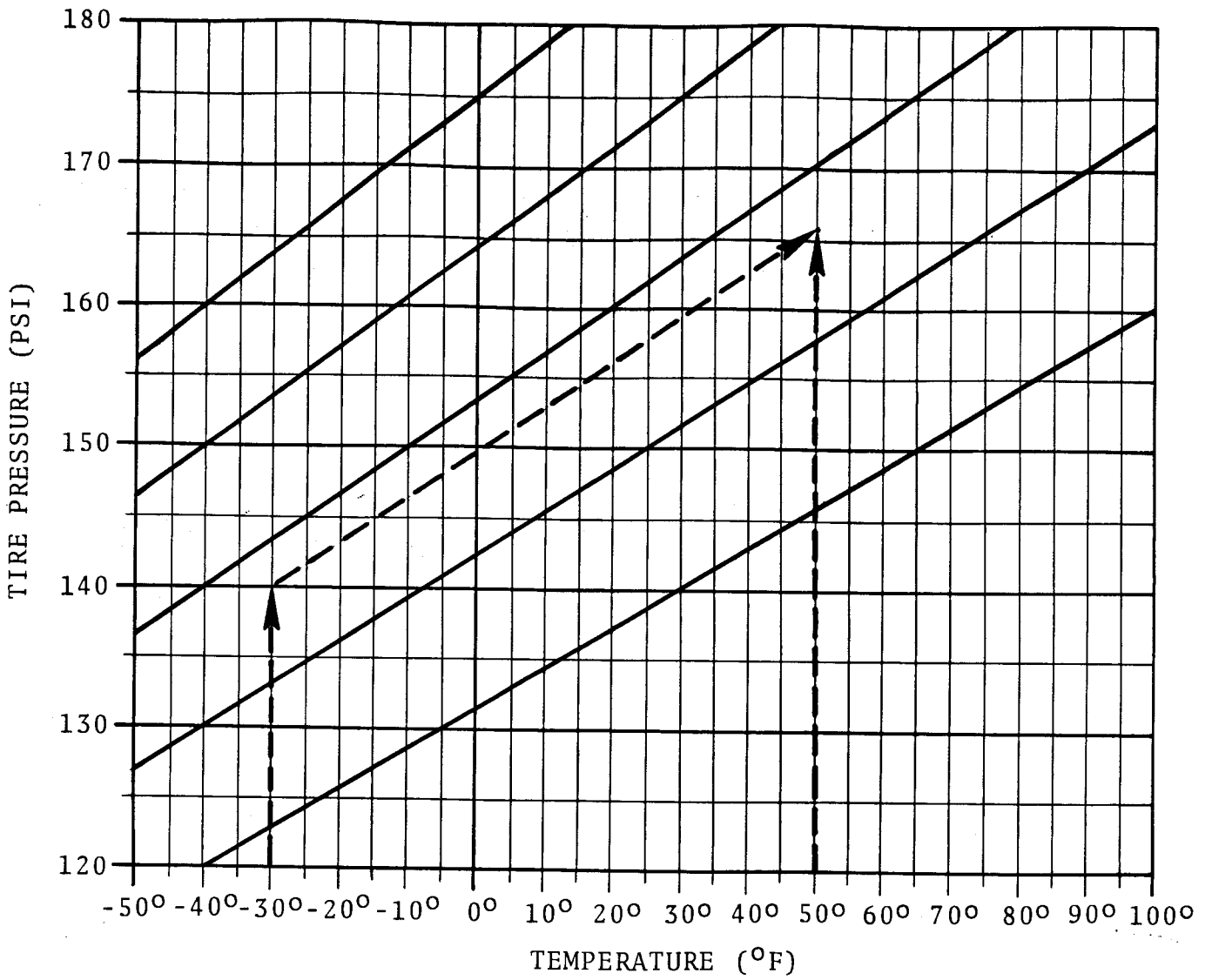

FIGURE #1

Figure 1 illustrates that with an expected destination temperature of  $-30^{\circ}\text{F}$ , tire pressure should be increased to 166 psi with an ambient temperature of  $50^{\circ}\text{F}$ .

REPORT OF RAPID TIRE PRESSURE LOSS

Model \_\_\_\_\_ S/N \_\_\_\_\_ Reg. No. \_\_\_\_\_

Date of Incident \_\_\_\_\_ Tire Involved: L.H. \_\_\_\_\_ R.H. \_\_\_\_\_

Number of Landings on Tire \_\_\_\_\_

Incident Occurred On: Taxi to T.O. \_\_\_\_\_ Approximate Speed \_\_\_\_\_  
Take-Off \_\_\_\_\_ Approximate Speed \_\_\_\_\_  
Landing \_\_\_\_\_ Approximate Speed \_\_\_\_\_  
Taxi After Landing \_\_\_\_\_

If incident occurred on Taxi or Take-Off, please complete the following:

Time on Ground \_\_\_\_\_ hrs. Hangared \_\_\_\_\_ Outside \_\_\_\_\_

Ambient Temp. \_\_\_\_\_ °F Time exposed to this Temp. \_\_\_\_\_

Tire Pressure \_\_\_\_\_ psi When was tire pressure checked \_\_\_\_\_

Approximate Gross Weight \_\_\_\_\_ Distance Taxied \_\_\_\_\_

Number of turns and direction while taxiing \_\_\_\_\_

If incident occurred on Landing or Taxi please answer:

Ambient Temp. at airport \_\_\_\_\_ °F

When was tire pressure last checked \_\_\_\_\_ Temp. \_\_\_\_\_ °F  
Pressure \_\_\_\_\_ psi

Please describe when tire pressure loss occurred. Include use of reverse thrust and amount of braking during rollout, number and direction of turns while taxiing.

\_\_\_\_\_  
\_\_\_\_\_  
\_\_\_\_\_

Please describe resulting damage to tire, wheel, etc., if any.

\_\_\_\_\_  
\_\_\_\_\_

Mail to: Jim Miller  
IAI International, Inc.  
2025 S. Nicklas  
Suite 115  
Oklahoma City, OK 73128

Reported by: \_\_\_\_\_  
Name \_\_\_\_\_  
Company \_\_\_\_\_  
Address \_\_\_\_\_  
Phone No. \_\_\_\_\_

# 1124-WESTWIND

## SERVICE INFORMATION LETTER

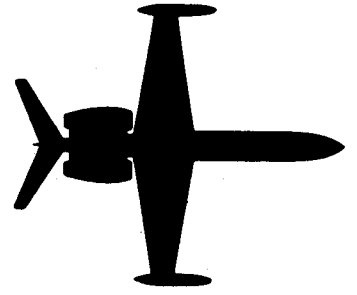

SIL No. 12

March 1, 1982

SUBJECT: AIRESEARCH SERVICE INFORMATION LETTER NO. 21-L-526

Attached you will find a copy of AiResearch Service Information Letter No. 21-L-526. This AiResearch publication covers oil change procedures for refrigeration units installed in 1124 Westwind series aircraft. IAI concurs with the procedures set forth in Airesearch SIL No. 21-L-526.

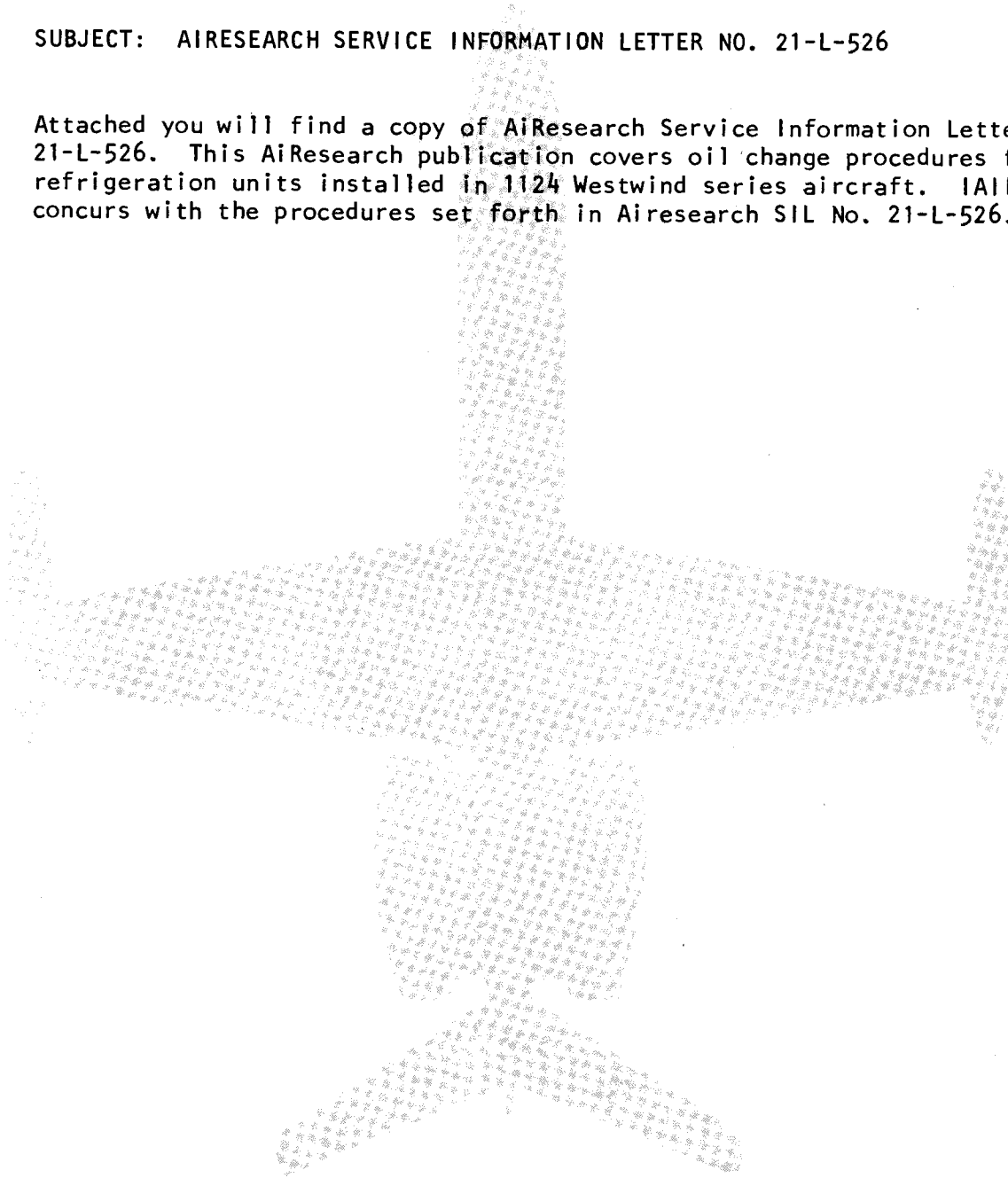

Page 1 of 1



SUBSIDIARY OF ISRAEL AIRCRAFT INDUSTRIES. LTD.  
BEN GURION AIRPORT, ISRAEL



# AIRESEARCH MANUFACTURING COMPANY OF CALIFORNIA

A DIVISION OF THE GARRETT CORPORATION

2525 WEST 190TH STREET • TORRANCE, CALIFORNIA 90509

TELEPHONE: (213) 323-9500, 321-5000 • CABLE: GARRETTAIR TORRANCE

S.I.L. 21-L-526  
December 7, 1981  
Page 1 of 1

## S E R V I C E   I N F O R M A T I O N   L E T T E R

TO: All 1124 Westwind Operators

SUBJECT: Recommended Oil Change Procedure for P/N 572375, Cooling Turbine Used in P/N 2200165, Refrigeration Unit

REFERENCE: Operations and Maintenance Instructions 4-272

Examinations of turbines returned from the field indicate that higher than desired operating temperatures occur during some flight and ambient conditions. The high temperatures contribute to carbon formation in the lubricating oil, which hinders the oil flow to the bearings. This restriction in flow reduces the lubrication at the bearing and can increase bearing wear and reduce turbine life.

AiResearch recommends that at the normal oil check period, the oil should be drained through the drain port on the bottom of the turbine, and fresh oil added to the top of the fill port per the referenced manual.

The referenced manual will be revised to incorporate this procedure.

Ernie Miller  
Customer Service Engineer

APPROVED:

Preston G. Holland  
Manager, Field Service

# **24-WESTWIND**

## **SERVICE INFORMATION LETTER**

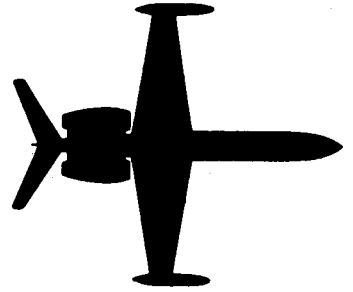

SIL NO. 13 (Rev. 1)

November 12, 1984

(This Service Information Letter supercedes SIL NO. 13 dated March 1, 1982 in its entirety).

**SUBJECT: ROCKWELL-COLLINS WXR300 RADAR SYSTEM DESSICANT REPLACEMENT.**

All aircraft equipped with the Rockwell-Collins WXR300 Radar System have a crystal dessicant bottle installed on a shelf in the right nose compartment.

The dessicant bottle should be checked frequently to determine if it is still effective. A color comparison chart is affixed to the bottle to assist in this check. Should the crystal color indicate replacement is required, a dessicant refill is available from any Rockwell-Collins dealer by ordering P/N 013-1399-020.

In the event it becomes necessary to replace the dessicant bottle, a complete plastic dessicator assembly may be obtained by ordering Rockwell-Collins P/N 013-1399-010. The plastic dessicator assembly includes one refill and is also available from any Rockwell-Collins dealer.



SUBSIDIARY OF ISRAEL AIRCRAFT INDUSTRIES. LTD.  
BEN GURION AIRPORT, ISRAEL

# **24-WESTWIND**

## **SERVICE INFORMATION LETTER**

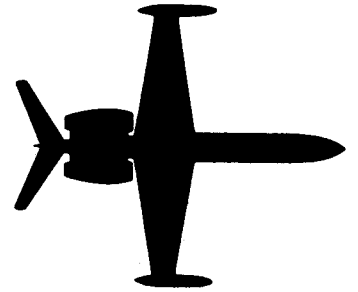

S I L NO. 13

MARCH 1, 1982

**SUBJECT: ROCKWELL-COLLINS WXR300 RADAR SYSTEM DESSICANT  
REPLACEMENT.**

All aircraft equipped with the Rockwell-Collins WXR300 Radar System have a crystal dessicant bottle installed on a shelf in the right nose compartment.

The dessicant bottle should be checked frequently to determine if it is still effective. A color comparison chart is affixed to the bottle to assist in this check. Should the crystal color indicate replacement is required, a dessicant refill is available from any Rockwell-Collins dealer by ordering P/N 01399-020.

In the event it becomes necessary to replace the dessicant bottle, a complete plastic dessicator assembly may be obtained by ordering Rockwell-Collins P/N 13-1399-010. The plastic dessicator assembly includes one refill and is also available from any Rockwell-Collins dealer.



Page 1 of 1



SUBSIDIARY OF ISRAEL AIRCRAFT INDUSTRIES, LTD.  
BEN GURION AIRPORT, ISRAEL

# 1124-WESTWIND

## SERVICE INFORMATION LETTER

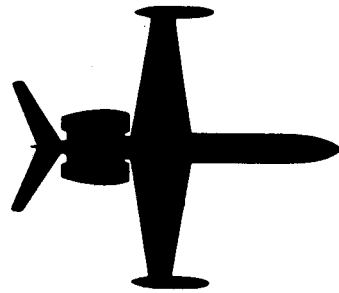

S I L NO. 14

MARCH 1, 1982

SUBJECT: AIRESEARCH SERVICE INFORMATION LETTER NO. 21-L-522

Attached you will find a copy of AiResearch Service Information Letter No. 21-L-522. This AiResearch publication covers P/N 188682-1 Heat Exchanger inspection and cleaning. These heat exchangers are part of the 1124 Westwind series refrigeration units. IAI recommends that each operator establish inspection intervals to suit his location and type of operation to obtain optimum service from the refrigeration unit.

Page 1 of 1



SUBSIDIARY OF ISRAEL AIRCRAFT INDUSTRIES, LTD.  
BEN GURION AIRPORT, ISRAEL





S.I.L. 21-L-522  
December 1, 1981  
Page 1 of 2

S E R V I C E   I N F O R M A T I O N   L E T T E R

TO:            All IAI Westwind 1124 Operators Using P/N 2200165 Refrigeration Units

SUBJECT:      P/N 188682-1 Heat Exchanger, Inspection and Cleaning

REFERENCE:   AiResearch Operation and Maintenance Instructions #4-272

Experience has indicated that high time heat exchangers, with approximately 5,000 hours or more, may develop leaks in the bleed air passages and/or can be plugged by foreign particles in the ram air passages.

Either condition can cause high bleed air temperatures to the cooling turbine, which can reduce turbine life, and can contribute to inadequate cabin cooling.

Due to the various degrees of environmental cleanliness, the actual flight hours before a heat exchanger problem occurs will vary considerably. The frequency of heat exchanger inspection and cleaning should, therefore, be established by individual operator experience.

AiResearch recommends an inspection and test of the heat exchanger be accomplished after the related E.C.S. System components have been checked for proper operation.

An on-site inspection and check can be accomplished as follows:

- 1) Remove refrigeration unit from aircraft and remove cooling turbine from heat exchanger.
- 2) Shine a light through cooling air passages and visually check for presence of particles.
- 3) Steam clean cooling air passages from side opposite normal air inlet side.
- 4) Reinspect cooling air passages for cleanliness.
- 5) Seal bleed air inlet and outlet for primary heat exchanger with suitable caps to apply air pressure to this primary bleed air section.
- 6) Apply air pressure of 250 psig to the primary bleed air section for two (2) minutes at room temperature. Reduce pressure to 140 psig and close the shutoff valve. Observe pressure decay for two (2) minutes. The pressure should not decay more than 60 psig during this time. Reduce pressure to ambient and inspect for deformation. There shall be no sign of permanent deformation.

(Continued...)

- 7) Repeat this procedure on the bleed air secondary heat exchanger. Pressurize this section to 150 psig for the proof pressure test. Reduce to 105 psig and observe decay for two (2) minutes. This decay should not exceed 35 psig during this time. Inspect for deformation.

Any heat exchanger determined to be unacceptable can be returned to AiResearch Manufacturing Company for more extensive cleaning and repair.

CAUTION: PROVIDE PERSONNEL WITH APPROPRIATE SAFETY PROTECTION.



Art Sitas  
Customer Service Engineer

APPROVED:



Preston G. Holland, Manager  
Field Service

# 1124-WESTWIND

## SERVICE INFORMATION LETTER

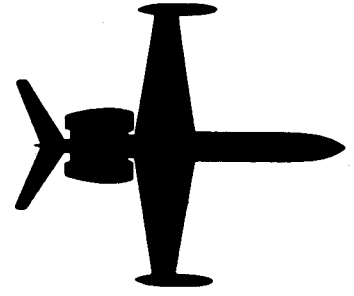

S I L NO. 15

MARCH 1, 1982

SUBJECT: 1124 TIME LIMIT CHANGES.

The following changes have been approved for incorporation into the Replacement and Overhaul section of 1124 Maintenance Manual Chapter 5.

<u>COMPONENT</u>	<u>P/N</u>	<u>OVERHAUL OR REPLACE</u>
REFRIGERATION UNIT - 3 Wheel Cooling Turbine	575375-1	O/C
	575375-2	O/C
	or 575375-3	O/C
OXYGEN SYSTEM - Control Panel Regulator Pressure Reduce	119077-12	O/C
	112031-06	O/C

These changes will appear in a forthcoming revision to Chapter 5 of the Maintenance Manual.



SUBSIDIARY OF ISRAEL AIRCRAFT INDUSTRIES, LTD.  
BEN GURION AIRPORT, ISRAEL

# 24-WESTWIND

## SERVICE INFORMATION LETTER

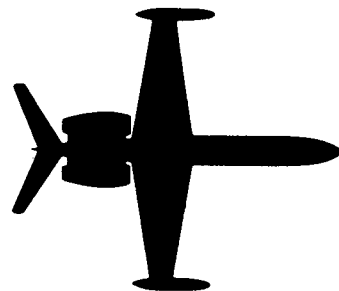

S I L NO. 16

MARCH 1, 1982

SUBJECT: LEAR SIEGLER STARTER/GENERATOR BRUSH INSPECTION

In response to reports of apparently excessive brush wear, the following information is provided.

1. The brush inspection data contained in the Westwind Maintenance Manual, Chapter 80-10-00, referred to in Chapter 5-20-00, Page 237, Para. 8.C. is applicable to the General Electric starter generator only.
2. Refer to your Lear Siegler Maintenance Manual, File No. 237-00, dated March 15, 1979, for brush inspection and replacement procedures.
3. Figure 2 of the manual illustrates brush wear stages. If the wear groove indication is compared to operating hours, you should be able to predict the approximate time that brush replacement will be required.

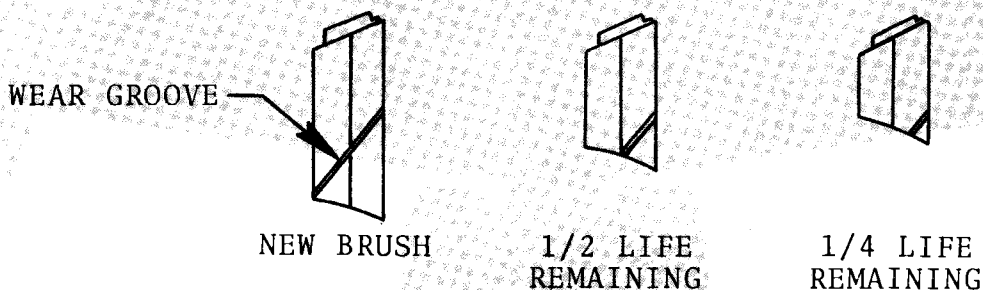

Figure 2. Illustration of Brush Wear Stages

If this procedure is followed, we believe it will provide satisfactory results for generator brush inspections and detect premature brush failure.

We recommend when new brushes are installed an evaluation inspection be performed between 10 and 20 operating hours.

# 1124-WESTWIND

## SERVICE INFORMATION LETTER

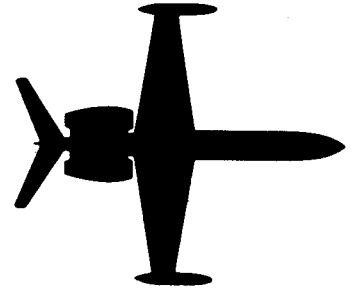

S I L NO. 17

MARCH 1, 1982

SUBJECT: 1124 WESTWIND FUEL MANAGEMENT PROCEDURE.

It is possible for fuel to be pumped overboard thru the fuselage fuel vent drain line after filling all tanks. This can occur if fueling is accomplished with electrical power ON and some fuel is introduced or left in the tip tanks.

This subject was covered in the August and September 1981 Westwind Communicators. A change has been made in the 1124A Airplane Flight Manual requiring the EXT PWR and BATTERY MASTER switches to be CYCLED OFF and ON during the PRE-START sequence. A similar change will be made to the 1124 Airplane Flight Manual.

If you must fuel the aircraft with electrical power ON (which IAI does not recommend), and do not want to cycle the EXT PWR and BATTERY MASTER switches OFF and ON, then it is possible to release the holding circuit of the Automatic Transfer Relay by pulling and resetting the Automatic Transfer circuit breaker.



INTERNATIONAL INC.  
ISRAEL AIRCRAFT INDUSTRIES INTERNATIONAL INC

SUBSIDIARY OF ISRAEL AIRCRAFT INDUSTRIES, LTD.  
BEN GURION AIRPORT, ISRAEL

# 24-WESTWIND

## SERVICE INFORMATION LETTER

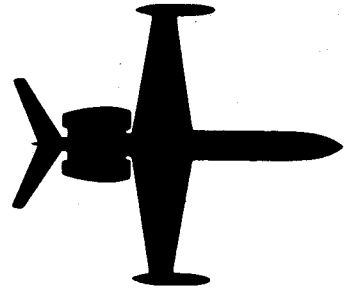

S I L NO. 18  
REVISION NO. 1

JULY 30, 1982

This revision superceeds S I L NO. 18, dated March 1, 1982 in its entirety.

SUBJECT: FLAP SYSTEM FLEX SHAFT PIN REPLACEMENT.

Groove pins have replaced roll pins on some flap system flex shafts P/N 193545-501 and -505 where the spline collar attaches at the in-board end. This has made compliance with Service Letter No. WW-2424 difficult. It is recommended that grooved pins be replaced with roll pins P/N MS9047-101 or MS9048-101 at time of next relubrication. Pin replacement may be accomplished as follows:

1. Remove flex shaft from aircraft.
2. Grind or file off peened end of pin.
3. Drive out pin with pin punch.
4. Comply with S/L WW-2424 reinstalling new roll pin during flex shaft reassembly.

#### NOTE

Hole dimension for both -101 pins must be .125 to .129 inch diameter. If hole dimension exceeds these limits it may be reamed to .156 to .160 and an oversize roll pin MS9047-132 or MS9048-132 should be installed.

Page 1 of 1



SUBSIDIARY OF ISRAEL AIRCRAFT INDUSTRIES. LTD.  
BEN GURION AIRPORT, ISRAEL

# **24-WESTWIND**

## **SERVICE INFORMATION LETTER**

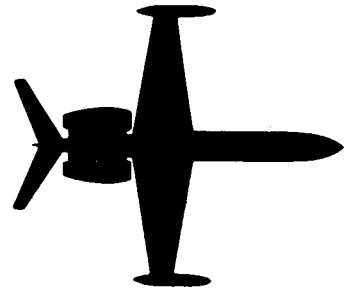

S I L No. 19

May 1, 1982

**SUBJECT: APPLICATION INSTRUCTIONS FOR SKIN TEMPERATURE  
SENSOR.**

Skin sensor should be applied to applicable surface at temperature above 50°. The sensor and skin surface must be dry and free from contamination.

1. Clean sensor mating surface and skin with MEK to remove any old adhesive or other contamination.
2. Apply transfer tape Scotch No. 467 to the sensor mating surface.
3. Remove adhesive protective liner and position skin sensor in desired location. Exert a uniform and firm hand pressure to ensure complete contact.

Page 1 of 1



SUBSIDIARY OF ISRAEL AIRCRAFT INDUSTRIES. LTD.  
BEN GURION AIRPORT. ISRAEL

# 1124-WESTWIND

## SERVICE INFORMATION LETTER

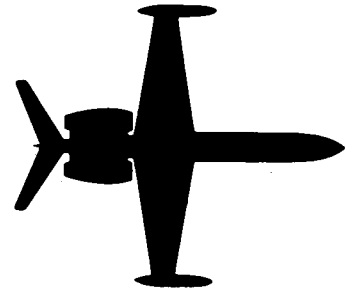

SIL NO. 20B

March 20, 1985

This SIL supersedes SIL No. 20A, dated February 1, 1984 in its entirety.

SUBJECT: INTERTECHNIQUE FUEL BOOST PUMPS, P/N 5653744-1, 501  
AND -503 BRUSH INSPECTION

Brush replacement and overhaul of the pumps have been changed to "On Condition."

It is recommended that operators continue to keep track of the actual operating time on the main and alternate pumps. Aircraft operating time may not be an accurate record of pump operating time especially with regard to the alternate pump.

Brush inspection requires removal of the pump from the aircraft and partial disassembly. After inspection, the pump is reassembled with a new seal. The pump must then be leak checked. The leak check can only be accomplished by an authorized overhaul agency.

Brush replacement and pump overhaul requirements in Chapter 5 of the Maintenance Manual will be changed to "On Condition" and Chapter 28 procedures will be updated to reflect those changes in the next revision of the 1124/1124A Maintenance Manual.



SUBSIDIARY OF ISRAEL AIRCRAFT INDUSTRIES, LTD.  
BEN GURION AIRPORT, ISRAEL



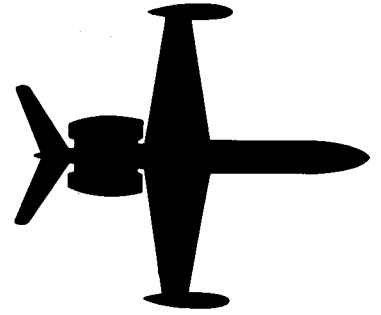

## SERVICE INFORMATION LETTER

---

S I L NO. 21

AUGUST 31, 1982

SUBJECT: NCS31A READ OUT PROBLEMS

Several problems have been encountered with the NCS31A system. Cold turn on errors, read out blinking or going blank when HSI selector changes are made. These problems occur only in those aircraft equipped with the Collins 639U-1 logic and lighting power supply used in the NCS31A system.

By accomplishing the following, the problems may be reduced or eliminated:

1. Visually check relays RL75, RL89, RL90, RL91, RL93, and RL120 for a 1N645 diode mounted across X1 and X2 terminals of each relay. Reference Wiring Manual pages 34-50-02 and 34-50-04 effective on your aircraft.
2. If diodes are not installed, add one 1N645 diode across each relay with the cathode end (bar or banded end) at X1 and the other end at X2.
3. Refer to S I L NO. 10 to check Ledex Rotary Solenoids.
4. Comply with Service Letter No. WW-2452 Part F, if not already accomplished.
5. If problems still exist, it may be necessary to replace the 639U-1 power supply.

Aircraft that use the KGS Model LT52A power supplies have not exhibited the same problems and may be used as a replacement for the Collins 639U-1 or the older EMP Model PS274A power supplies.

### NOTE

Refer to S/L WW-2452 Part C and D to properly program the KGS or EMP power supply.

# 24-WESTWIND

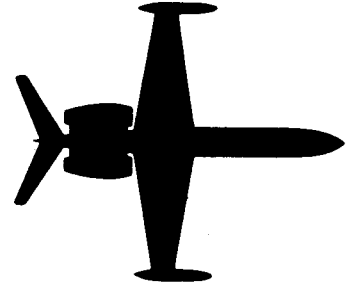

## SERVICE INFORMATION LETTER

S I L NO. 22

AUGUST 31, 1982

SUBJECT: SPERRY GH14A/B ATTITUDE GYRO INSTALLATIONS

The Sperry GH14A/B attitude gyro is used on the copilots side of single flight director equipped aircraft. Some of these gyros require shims P/N 883793-33/c be installed to correct displayed attitude to actual flight pitch angle.

The following Sperry GH14A/B attitude gyros may be installed in the Westwind:

<u>PART NUMBER</u>	<u>TILT ANGLE</u>	<u>SHIMS REQUIRED</u>	<u>ERROR REMAINING</u>
4020531-100	0°	YES	4°
4020531-150	6°	YES	0°
4020531-175	10°	NO	0°

Page 1 of 1



INTERNATIONAL INC.  
ISRAEL AIRCRAFT INDUSTRIES INTERNATIONAL INC

SUBSIDIARY OF ISRAEL AIRCRAFT INDUSTRIES, LTD.  
BEN GURION AIRPORT, ISRAEL

# 24-WESTWIND

## SERVICE INFORMATION LETTER

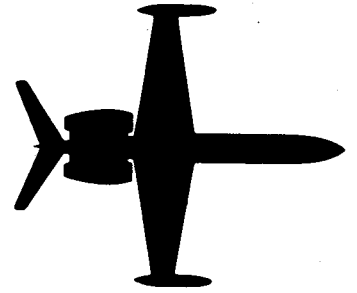

S I L NO. 23

AUGUST 31, 1982  
REVISED NOVEMBER 30, 1982

SUBJECT: INTERCOM SYSTEM AUDIO CLARITY.

1. Locate Pilot's and Co-Pilot's 346B3 audio control center units.
2. Check continuity between pin 49 in plug DB49C and pin 49 in plug DB50C.
3. If continuity exists between plugs, take the following corrective action:
  - a. Locate terminal board T13 (reference S/B WW-24-23 to assist in locating T13) terminal 13.
  - b. Disconnect wire RZ31A or RZ31B. Cap and stow disconnected wire to open cross over circuit.

#### NOTE

With cross over circuit open operation of the intercom system and hot mic will not be effected; however, intercom audio will be clearer.

4. Incorporate Rockwell-Collins Service Bulletin No. 8 on both 346B3 audio control centers and adjust in accordance with S/B 8.

Page 1 of 1



INTERNATIONAL INC.  
ISRAEL AIRCRAFT INDUSTRIES INTERNATIONAL INC.  
SUBSIDIARY OF ISRAEL AIRCRAFT INDUSTRIES, LTD.  
BEN GURION AIRPORT, ISRAEL

# 24-WESTWIND

## SERVICE INFORMATION LETTER

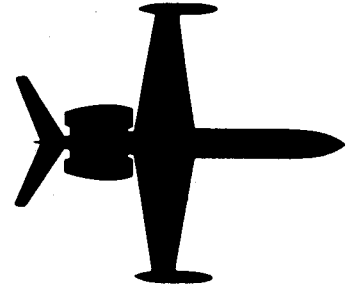

S I L NO. 24

SEPTEMBER 7, 1982

SUBJECT: MICROPHONE SYSTEM UPDATE

EFFECTIVITY: 1124/1124A WESTWINDS S/N 187 THRU 257, EXCEPT 254, AND ALL AIRCRAFT WITH COM 3 OPTION INSTALLED.

### NOTE

This S I L is for information and planning purposes only. For further details, contact the IAI Avionics Representative, Ray Negstad at 302 322-7344.

Production changes have been made in later serial number Westwinds that will allow independent use of the boom and oxygen mics (with wheel mounted switch) and the hand mic. This can be accomplished without unplugging any one of the mics to use any other, and without relay "pops". These changes will also allow use of the boom and oxygen mics on VHF 251 Com 3 option, if it is installed per IAI drawings. Presently VHF 251 is limited to hand mic operation.

Aircraft wiring will be upgraded to the following drawing configurations if this modification is accomplished:

23-50-01	Without	Com 3	-	page 9	(CMA07-2071-54C)
	With	Com 3	-	page 13	(CMA07-2071-72A)
23-50-02	Without	Com 3	-	page 8	(CMA07-2072-54D)
	With	Com 3	-	page 11	(CMA07-2072-72A)
23-50-04	With or W/O	Com 3	-	page 2	(CMA07-2074-51 New)

Changes are made in the following areas: Mic jacks, TB202 and TB203 (just aft of rudder pedals under floor), and both audio panels. It will be necessary to add diodes, switches, jack insulating washers and a third mic jack on some installations.

Page 1 of 1



SUBSIDIARY OF ISRAEL AIRCRAFT INDUSTRIES, LTD.  
BEN GURION AIRPORT, ISRAEL

# 24-WESTWIND

## SERVICE INFORMATION LETTER

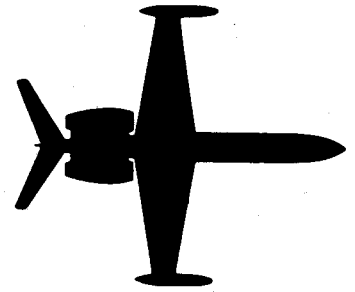

S I L NO. 25

SEPTEMBER 7, 1982

SUBJECT: AFT BAGGAGE COMPARTMENT MIC WIRING CONFORMITY CHECK.

EFFECTIVITY: 1124/1124A WESTWIND, S/N 240 AND SUBS.

1. Gain access to pilot's audio control center and terminal board T 14. In most aircraft the units are located at floor level behind vanity.
2. Reference Wiring Manual pages 23-50-03 effective on your aircraft and locate plug DB49C and terminal board T 14.
3. Accomplish the following checks with the aid of an ohm meter:
  - a. Assure that wires on terminal board T 14 terminals 10 and 14 are not reversed. Terminal 14 is grounded and should have wire shield grounds attached. Terminal 10 should have wire number RZ32A24 attached.
  - b. With ohm meter, assure that wire RZ32A24 connects between T 14 terminal 10 and DB49C pin 51. This wire must not go to pin 49 as has been found on some installations.
  - c. Make sure terminal board T 14 terminal 14 is properly grounded.
4. Reference Wiring Manual pages 23-50-06 effective your aircraft and ensure that wire shield ground for wire RZ337B24 is connected to terminal board T 14 terminal 14 and not terminal 15 as shown in Wiring Manual.
5. Check aft baggage mic and phone jacks to assure they are not grounded at their mounting (these jacks are grounded at the audio centers). Add insulating shoulder washers, if required, to insulate mounting of jacks.

Accomplishment of the 5 Steps listed above will correct weak or inoperative baggage compartment mic, or squealing in the cockpit intercom system.

The aft baggage compartment communication system is operational from pilot's side only. Should the cabin call bell ring when the aft headset is plugged in, the bell can be silenced by pulling DC circuit breakers for autopilot annunciator and flightphone.



INTERNATIONAL INC.  
ISRAEL AIRCRAFT INDUSTRIES INTERNATIONAL INC.  
SUBSIDIARY OF ISRAEL AIRCRAFT INDUSTRIES LTD.  
BEN GURION AIRPORT, ISRAEL

Page 1 of 1.

# 24-WESTWIND

## SERVICE INFORMATION LETTER

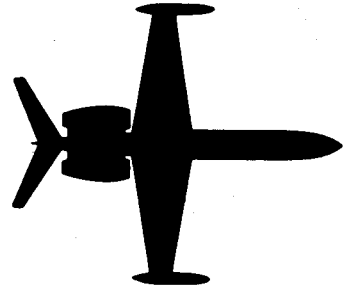

S I L NO. 26

SEPTEMBER 7, 1982

SUBJECT: #1 OR #2 COMPASS SYSTEM - DG SWITCH MODIFICATION.

EFFECTIVITY: 1124/1124A WESTWIND, S/N 154, 181, 205 AND SUBS,  
EXCEPT 288 AND 336.

The following modification will allow operation of the flight director and RNS 300 systems, without heading warning, when compass switch is moved to "DG" or free position.

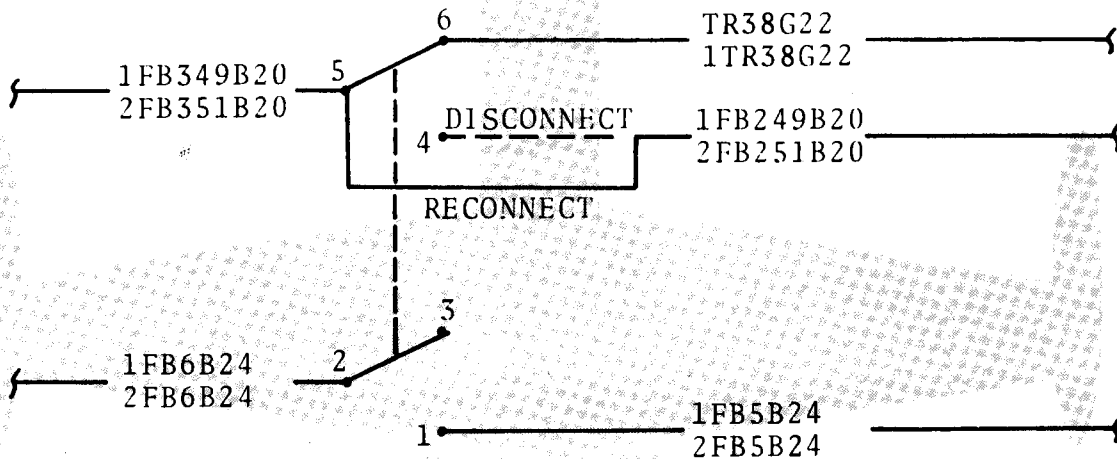

S31(#1) or S32(#2) DG SELECTOR SWITCH

These changes will still allow for proper system failure warnings.

# 24-WESTWIND

## SERVICE INFORMATION LETTER

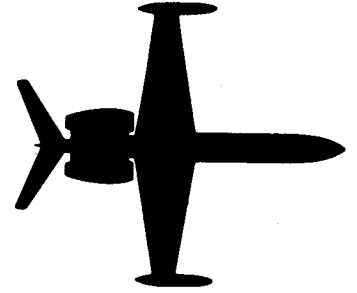

S I L No. 27

November 30, 1982

SUBJECT: UPPER AND LOWER NLG BEARING PRECAUTIONS

It has come to the attention of IAI that pressure washing procedures used in the area of the nose landing gear may be contributing to failures of the upper and lower strut bearings.

It is recommended that special precautions be taken to prevent water from being forced thru the strut seal areas during wash down of the nose gear. These areas should be covered while using pressure washers and the area hand cleaned and thoroughly dried after cleaning.

Compliance with Service Letter No. WW-2491 will improve the sealing of the strut and reduce the possibility of moisture getting to these bearings. Also the inspection and lubrication recommended by this service letter will further protect the bearings from damage and failure should any moisture get by the strut seals.

Page 1 of 1



SUBSIDIARY OF ISRAEL AIRCRAFT INDUSTRIES, LTD.  
BEN GURION AIRPORT, ISRAEL

# 24-WESTWIND

## SERVICE INFORMATION LETTER

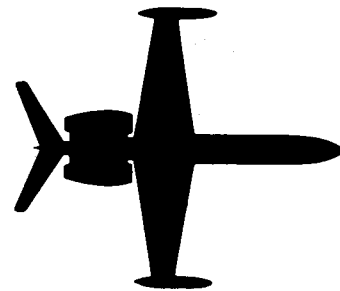

S I L No. 28

November 30, 1982

SUBJECT: LEARAVIA BATTERY TEMP SYSTEM TESTS, 1124/1124A WESTWINDS.

The system test built into the aircraft tests only the internal comparator and lamp driver, not the sensor probes or interconnect harness.

The following chart gives the equivalent resistance measurements for the 800508-1 (stud mount) and 800508-2 (bond mount) thermister probes used with the LearAvia Battery Temperature Indicator used in the Westwind:

<u>TEMP INDICATOR READING (°F)</u>	<u>EQUIVALENT RESISTANCE (IN OHMS)</u>
32°F	32,650
60°F	15,000
77°F	10,000
100°F	5,777
140°F	2,488
180°F	1,177
212°F	678

By disconnecting the temp probe plug at the battery case and substituting the above resistor values, an excellent accuracy test can be performed on the system.

Page 1 of 1



SUBSIDIARY OF ISRAEL AIRCRAFT INDUSTRIES, LTD.  
BEN GURION AIRPORT, ISRAEL



# 24-WESTWIND

**SERVICE**

## **INFORMATION LETTER**

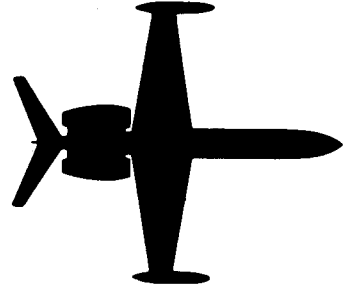

S I L No. 29

NOVEMBER 30, 1982

SUBJECT: WING ROOT LOWER ACCESS PANEL ATTACHMENT CHECK.

There are ten (10) screws in the lower wing root access plate on each wing. Removal of this plate was required to accomplish Service Letter No. WW-2466 and is required during routine inspection of the aircraft.

All screws should be removed from these access plates and the aileron push-pull tube checked for scratches that could have been caused by the one long screw, required in each plate, being installed in the wrong location. If scratches are found in push-pull tube they must be polished out before reinstalling access plates.

Reinstall access plates with 9 each MS24694S48 screws and 1 each MS24694S49 screw (longer screw must go thru spar cap angle). It is recommended that the longer MS24694S49 screw heads and their location on the access plates be color coded before reinstallation.

Page 1 of 1



SUBSIDIARY OF ISRAEL AIRCRAFT INDUSTRIES. LTD.  
BEN GURION AIRPORT, ISRAEL

# 1124-WESTWIND

**SERVICE**

**INFORMATION LETTER**

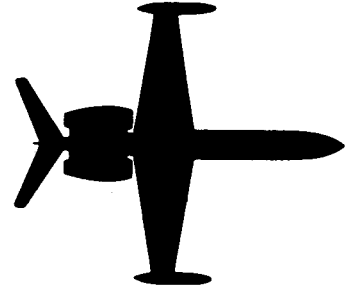

S I L NO. 30

February 28, 1983

SUBJECT: USE OF BIOBOR JF FUEL ADDITIVE

Attached is a copy of U.S. Borax Service Bulletin No. 978 on the use of Biobor JF fuel fungicide for your information.

Refer to Chapter 12 of the Maintenance Manual for use of Biobor JF in 1124/1124A Westwinds.

Page 1 of 1



SUBSIDIARY OF ISRAEL AIRCRAFT INDUSTRIES. LTD.  
BEN GURION AIRPORT, ISRAEL

# **24-WESTWIND**

## **SERVICE INFORMATION LETTER**

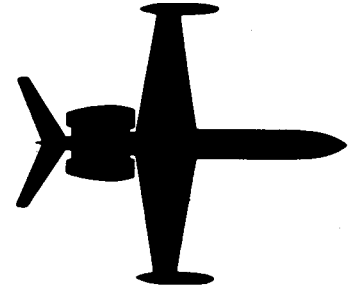

SIL No. 31A

JULY 15, 1983

This Service Information Letter supercedes SIL No. 31, dated March 1, 1983, in its entirety.

**SUBJECT: REPLACEMENT OF BRAKE ASSEMBLY TO AXLE MOUNTING BOLTS.**

A new replacement bolt has been approved for brake assembly to axle mounting. The new bolts P/N NAS 6705-U8 should be installed as soon as practical but not to exceed the accumulation of 400 landings on existing bolts or brake overhaul, whichever occurs first.

The new bolts are manufactured from corrosion resisting steel and will replace all earlier cadmium plated bolts. Cadmium plated bolts should no longer be used for this installation.

See Service Letter No. WW-24103 for further details.

Page 1 of 1



SUBSIDIARY OF ISRAEL AIRCRAFT INDUSTRIES. LTD.  
BEN GURION AIRPORT, ISRAEL

# 24-WESTWIND

## SERVICE INFORMATION LETTER

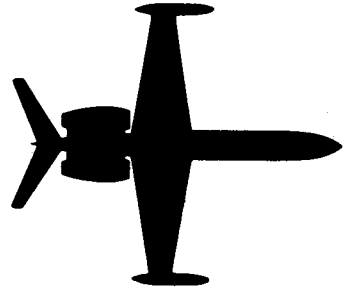

S I L No. 32

MARCH 31, 1983

SUBJECT: REPLACEMENT OF P/N 572375-3 COOLING TURBINE WITH P/N 572375-2 COOLING TURBINE.

Attached you will find a copy of Garrett AiResearch Service Bulletin No. 5-2297 dated Jan 15/81. This Garrett service bulletin provides the instructions for installation of Garrett Modification Kit No. 830164-2. This kit will allow a P/N 572375-2 turbine to replace a P/N 52375-3.

For updating of refrigeration units with P/N 572375-1 Series 2 turbines refer to Service Letter No. WW-2442.

Page 1 of 1



SUBSIDIARY OF ISRAEL AIRCRAFT INDUSTRIES. LTD.  
BEN GURION AIRPORT, ISRAEL



# SERVICE BULLETIN

Model 1124

REFRIGERATION UNIT - Conversion of 2200165-3 Refrigeration Unit (Field Retrofit) to 2200165-2 Refrigeration Unit (Production) by replacing cooling turbine

---

## SECTION 1

### PLANNING INFORMATION

#### A. Effectivity

This service bulletin is applicable to the following refrigeration units:

<u>Part No.</u>	<u>Serial No.</u>	<u>Aircraft Application</u>
2200165-3 Series 1	All	Model 1124

#### B. Reason

- (1) Problem: Requirement to install Part No. 572375-2 production Cooling Turbine in place of Part No. 572375-3 Cooling Turbine has occurred in the field.
- (2) Background: Part No. 572375-2 production Cooling Turbine is usable in Part No. 2200165-3 Refrigeration Unit with addition of an adapter.
- (3) Action: Replace Part No. 572375-3 Cooling Turbine with Part No. 572375-2 Cooling Turbine per this service bulletin.

#### C. Description

Replace 572375-3 Cooling Turbine with 572375-2 Cooling Turbine and add adapter assembly and cover plate to provide for connection to heat exchanger ram air inlet duct.

#### D. Approval

Not applicable.

#### E. Manpower

Approximately 2.0 man-hours are required for replacing cooling turbine, using 830164-1 Refrigeration Unit Modification Kit.

F. Materials - Availability

Description	Part No.	Qty per Unit	Remarks
Modification Kit, Refrigeration Unit	830164-2	1	*

\*Modification kit does not include 572375-2 Cooling Turbine.

G. Tooling - Price and Availability

No special tooling required.

H. Weight and Balance

None.

I. References

The sources of information used in the preparation of this service bulletin include AiResearch engineering documentation and applicable Operation and Maintenance Manual.

Operation and Maintenance Manual - Report No. 4-272

J. Other Publications Affected

None.

SECTION 2

ACCOMPLISHMENT INSTRUCTIONS

A. Method of Change

- (1) Remove 572375-3 Cooling Turbine (17, figure 1) from refrigeration unit. (Refer to Operation and Maintenance Manual - Report No. 4-272.)

NOTE: When removing turbine, sequence of parts removed (bolts, washers, etc) must be carefully noted for proper reassembly and installation of turbine.

- (2) Install new 2201977-1 Adapter Assembly with new 2201979-1 Cover Plate on replacement 572375-2 Cooling Turbine, using four new AN960PD10L Washers and four new NAS1351C3-10 Screws as shown in figure 2.

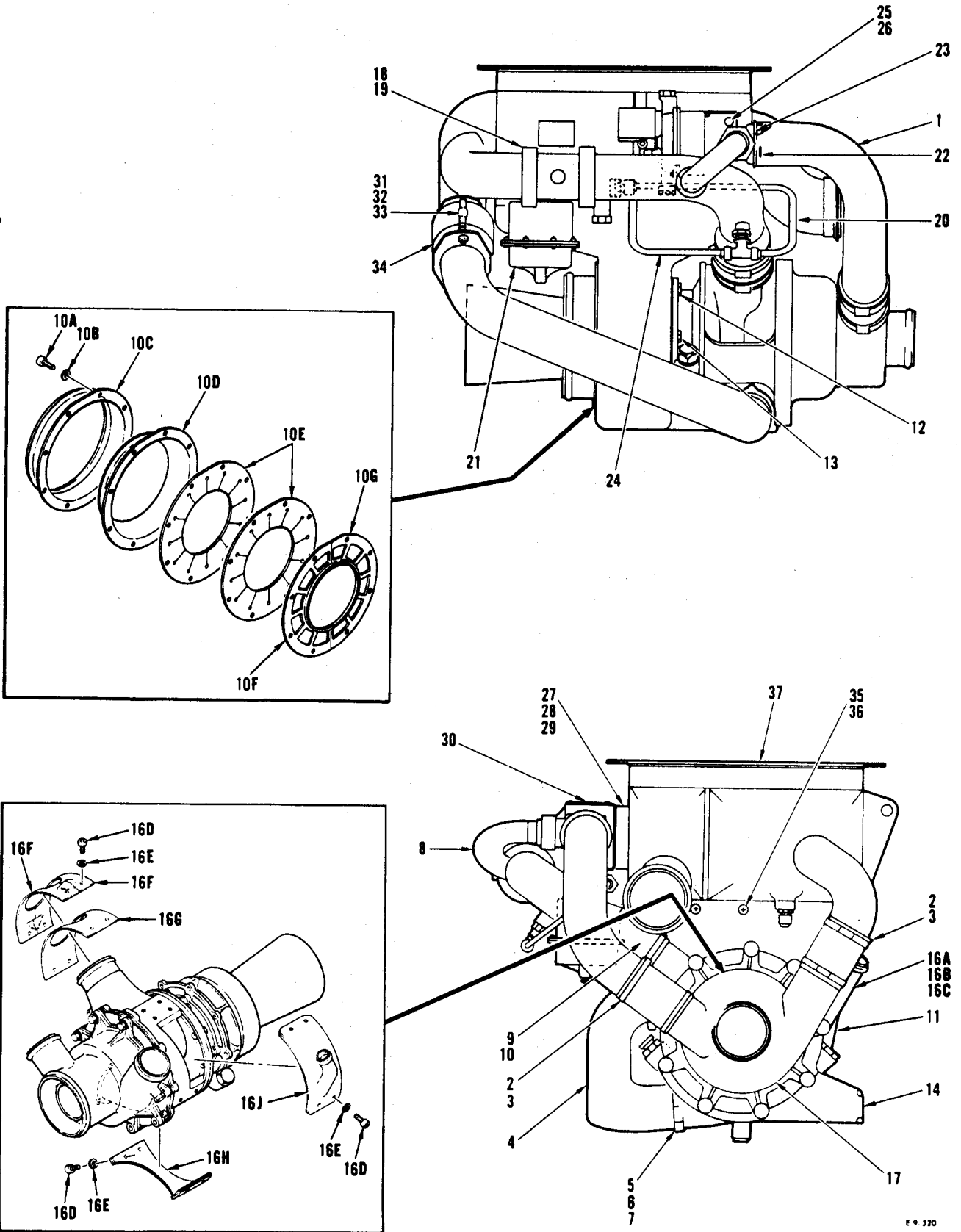

Aircraft Refrigeration Unit  
Figure 1

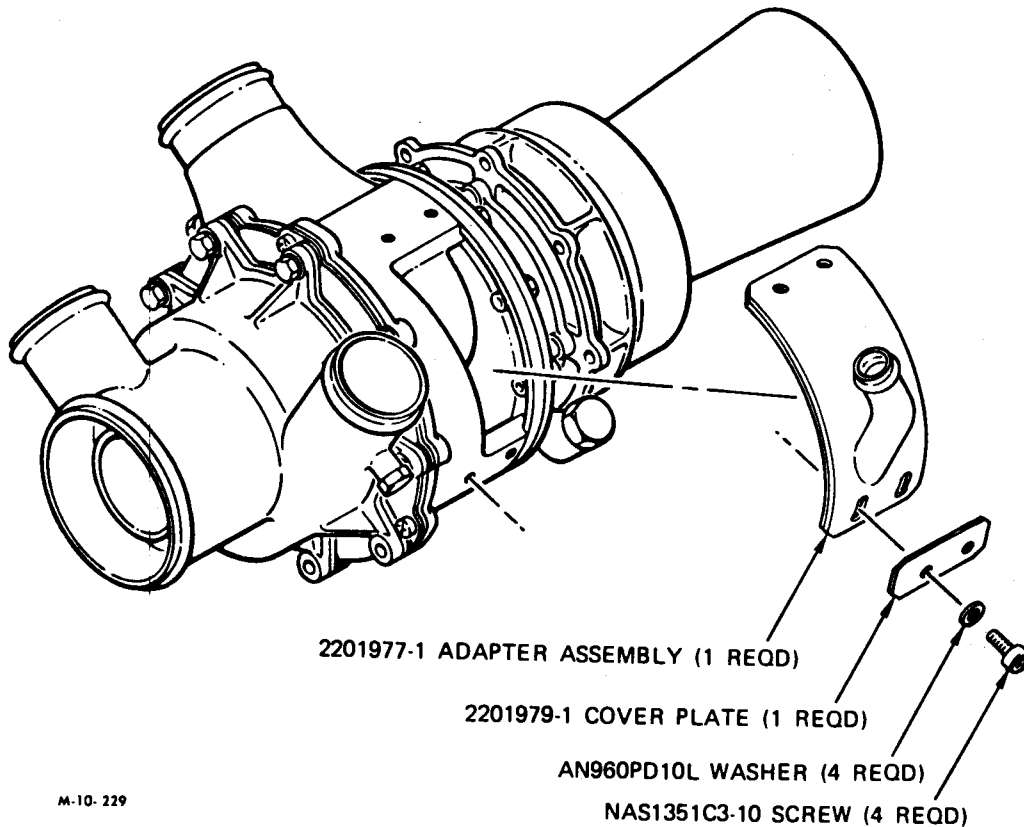

M-10-229

Installation of Adapter Assembly  
Figure 2

- (3) Add lubricating oil to cooling turbine and install cooling turbine in refrigeration unit in the aircraft. (Refer to Operation and Maintenance Manual - Report No. 4-272.)

NOTE: Install turbine in sequence noted during removal. When installing turbine bracket assembly (14, figure 1), torque the two turbine bolts 20 to 25 pound-inches.

- (4) Connect compressor outlet duct assembly (4), using new MS9068-032 Packing (7).
- (5) Connect anti-ice duct assembly (1), using new MS9068-132 Packing; install new MS24665-308 Cotter Pin (22) with head facing up.

#### B. Reidentification Instructions

- (1) After completing modification, reidentify 2200165-3 Series 1 Refrigeration Unit as 2200165-2 Series 1 Refrigeration Unit by replacing existing identification plate with new 2200799-2 Identification Plate. Transcribe all applicable data from old identification plate to new identification plate.



## SECTION 3

## MATERIAL INFORMATION

The following refrigeration unit modification kit is required for each refrigeration unit to be modified and may be obtained from Atlantic Aviation Corporation.

New Part No.	Qty	Key Words	Old Part No.	Instructions- Disposition
572375-2	1	Cooling Turbine	572375-3	A
830164-2	1	Modification Kit, Refrigeration Unit Consisting of:	---	---
220977-1	1	. Adapter Assembly	---	---
220979-1	1	. Cover Plate		
2200799-2	1	. Identification Plate	2200799-3	B
NAS1351C3-10	4	. Screw	---	---
AN960PD10L	4	. Washer	---	---
MS9068-032	1	. Packing	MS9068-032	B
MS9068-132	1	. Packing	MS9068-132	B
MS24665-308	1	. Cotter Pin	MS24665-308	B

Disposition Code A: Replace as specified in service bulletin.

Disposition Code B: Scrap.

# 24-WESTWIND

## SERVICE INFORMATION LETTER

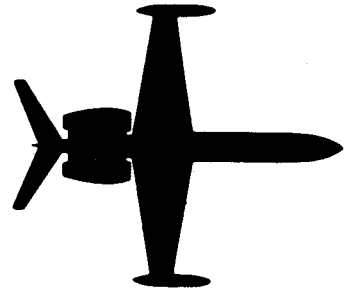

S I L No. 33

MARCH 31, 1983

SUBJECT: ENGINE CROSS START

Engine cross start is a normal procedure outlined in the AFM, titled "Starting Engines Using Battery Power".

Engine cross start may be defined as the procedure wherein the operating generator of the first engine started is operating in parallel with the aircraft batteries, thereby providing generator assist to the batteries for starting the second engine.

Step 16 of Normal Procedures reads "DC ammeter, operating engine - BELOW 100 AMPS (27.5V minimum).

Occasionally, the requirements of Step 16 may cause significant delay in initiating second engine start.

The operator may expedite second engine start by turning the operating generator switch OFF, then back ON. This will cause the generator to enter the 1.5 volt reduction mode and reduces generator output to less than 100 AMPS, during second engine start.

### NOTE

The procedure described for expediting start of the second engine may result in excessive discharge of batteries and thus shorten battery life.

Page 1 of 1



SUBSIDIARY OF ISRAEL AIRCRAFT INDUSTRIES, LTD.  
BEN GURION AIRPORT, ISRAEL

# 24-WESTWIND

## SERVICE INFORMATION LETTER

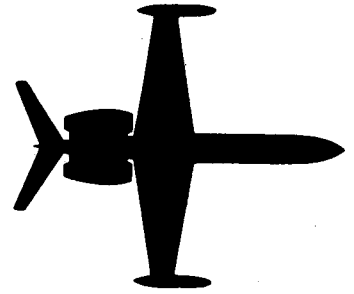

S I L NO. 34

APRIL 15, 1983

SUBJECT: INTERMITTENT COLLINS RACK MOUNT CONNECTORS.

Some aircraft are experiencing intermittent problems with the female "fork" contacts and coax connectors in the Collins "Thin Line" connectors used on the VIR 30, ADF 60, FCS 80, APS 80, etc.

These problems are generally observed while trouble shooting a system defect, and simply removing and reinstalling a suspect "black box" cures the problem.

For corrective measures, Collins has a kit available, containing a new connector, mounting adapter, and hardware for most "Pro Line" equipment.

Refer to Collins Pro Line Equipment Service Information Letter 1-82, dated 21 Jul 82 for kit part numbers. Pins are to be ordered separately.

This Collins SIL gives complete instructions, including special tooling required.

Page 1 of 1



INTERNATIONAL INC.  
ISRAEL AIRCRAFT INDUSTRIES INTERNATIONAL INC.  
SUBSIDIARY OF ISRAEL AIRCRAFT INDUSTRIES, LTD.  
BEN GURION AIRPORT, ISRAEL

# SERVICE PUBLICATIONS revision notice

---

SIL NO. 35

May 22, 1987

SUBJECT: VIBRATION LEVEL FOR #2 ALTIMETER

## CANCELLATION NOTICE

This Service Information Letter is hereby cancelled. All information contained herein has been incorporated in Service Bulletin No. 1124-34-071.

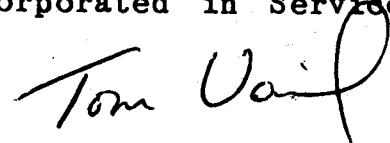

Tom Vail, Manager  
Technical Services

# 24-WESTWIND

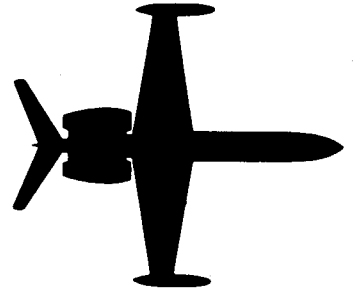

## SERVICE INFORMATION LETTER

S I L No. 35

May 16, 1983

SUBJECT: VIBRATION LEVEL FOR #2 ALTIMETER.

A small vibrator is built into the #2 altimeter to prevent needle sticking. On some aircraft a variable potentiometer (P1) is used to control voltage to the vibrator and thereby the level of vibration. There are other aircraft that have the vibrator circuit direct wired to receive a full 28V.

If your aircraft's #2 altimeter has developed sticking problems accomplish a voltage check by disconnecting the connector on the back of the altimeter and testing per Figure 1.

If voltage reads below 20V, locate printed circuit board P/N 5833513-9 (below copilot HSI) and adjust potentiometer (P1) to 16-18V or jumper potentiometer (P1) per Figure 2.

### NOTE

Noise level of vibrator will increase as voltage is increased.

Page 1 of 2



SUBSIDIARY OF ISRAEL AIRCRAFT INDUSTRIES, LTD.  
BEN GURION AIRPORT, ISRAEL

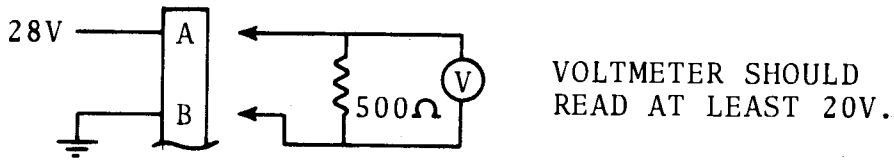
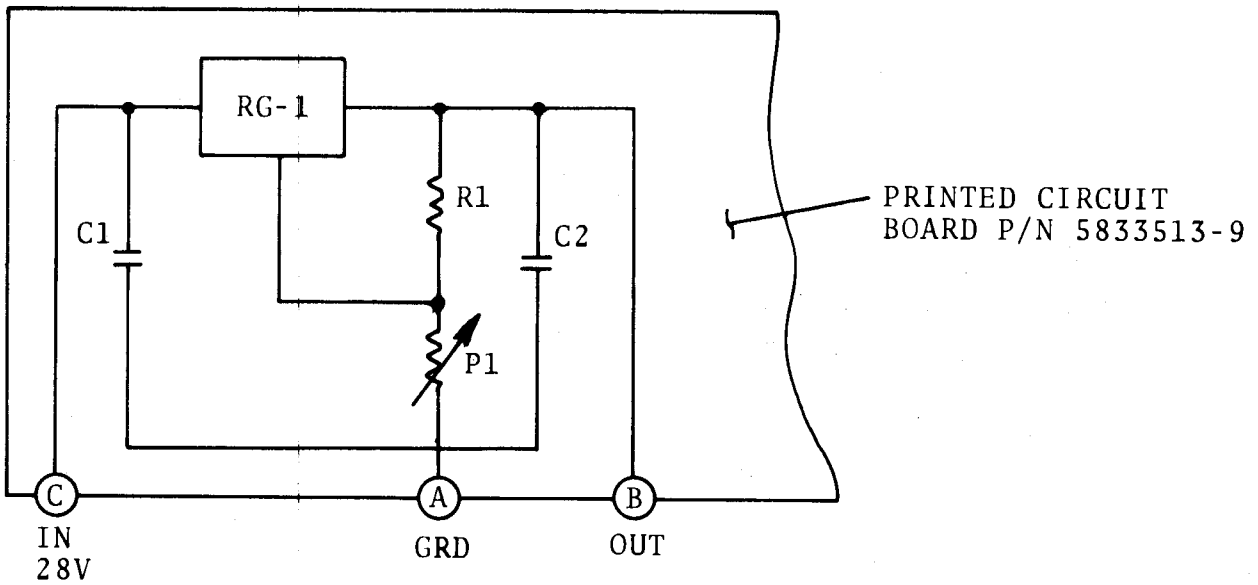

FIGURE 1 VOLTAGE TEST



NOTES

- Adjust P1 to 16-18V (A to B).
- OR
- Remove potentiometer P1 from circuit board.
- OR
- Jumper from B to C on female side of connector.

FIGURE 2 POTENTIOMETER P1 LOCATION

# 1124-WESTWIND

## SERVICE INFORMATION LETTER

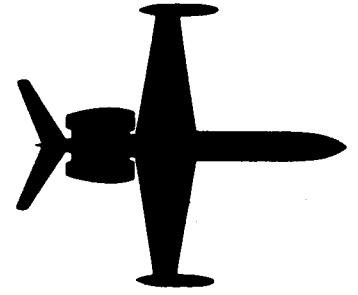

S I L No. 36

May 16, 1983

SUBJECT: 1124 WESTWIND REFRIGERATION UNIT INSTALLATION.

Attached is AiResearch Report No. 4-272 on the refrigeration unit used in 1124 Westwinds. This report covers operation and maintenance, including replacement of cooling turbine. Be sure and follow the procedures called out in Report 4-272, especially torque values for screws and bolts.

To further assure proper installation of refrigeration unit caution should be exercised in assembly of the Peri-Seal Coupling P/N 54A27 (located in the duct from the compressor outlet of the turbine to the secondary heat exchanger). New seals P/N 460-200 should be installed wherever Peri-Seal Coupling is disassembled or leakage is suspected. Reassemble Peri-Seal Coupling per Figure 1.

Page 1 of 2



SUBSIDIARY OF ISRAEL AIRCRAFT INDUSTRIES. LTD.  
BEN GURION AIRPORT, ISRAEL

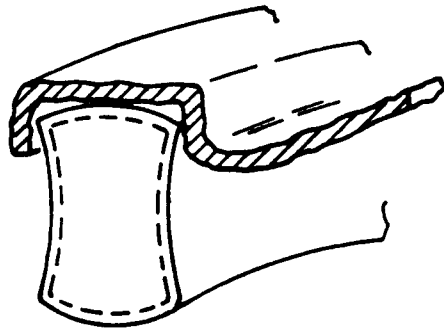
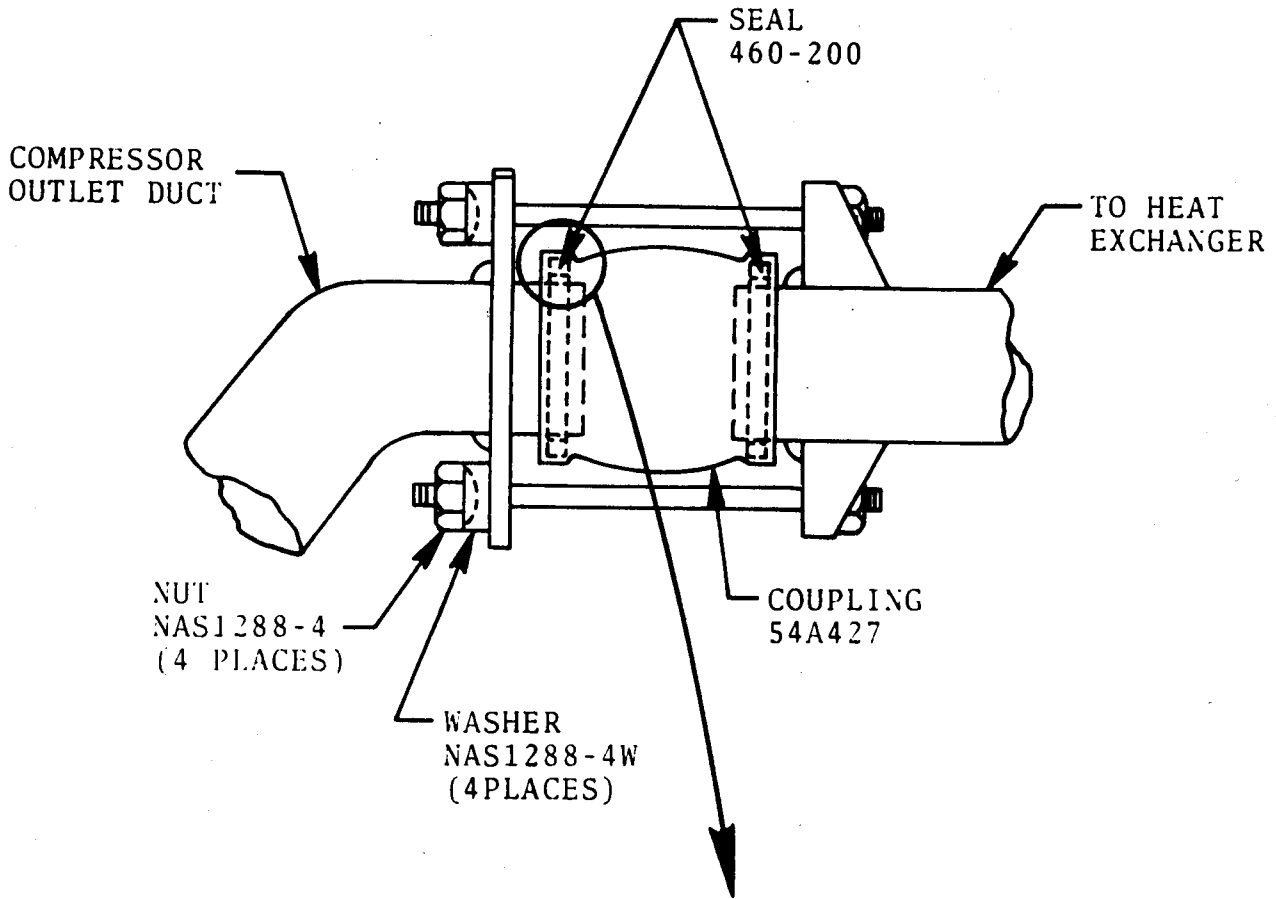

FIGURE 1 COOLING TURBINE  
COUPLING



**COMPLETE REPRINT**  
INCORPORATES ALL REVISIONS

1124

REPORT NO. 4-272

**Operation**  
**AND Maintenance**  
**INSTRUCTIONS**

AIRCRAFT REFRIGERATION UNITS

PART NO. 2200165-1

CONSISTING OF:

572375-1 THREE-WHEEL COOLING TURBINE  
188682-1 AIR/AIR DUAL HEAT EXCHANGER ASSEMBLY  
898730-1 FLUID PRESSURE REGULATING VALVE  
978836-1 MODULATING AND SHUTOFF VALVE

PART NO. 2200165-2

CONSISTING OF:

572375-2 THREE-WHEEL COOLING TURBINE  
188682-1 AIR/AIR DUAL HEAT EXCHANGER ASSEMBLY  
898730-1 FLUID PRESSURE REGULATING VALVE  
978836-1 MODULATING AND SHUTOFF VALVE

PART NO. 2200165-3

CONSISTING OF:

572375-3 THREE-WHEEL COOLING TURBINE  
188682-1 AIR/AIR DUAL HEAT EXCHANGER ASSEMBLY  
898730-1 FLUID PRESSURE REGULATING VALVE  
978836-1 MODULATING AND SHUTOFF VALVE

THIS PUBLICATION REPLACES REPORT NO. 4-272 DATED 1 MARCH 1982



**AIRESEARCH MANUFACTURING COMPANY OF CALIFORNIA**

A Division of The Garrett Corporation

2525 W. 190th Street, Torrance, California 90509

1 April 1983

**LIST OF EFFECTIVE PAGES**

INSERT LATEST REVISED PAGES. DESTROY SUPERSEDED PAGES.

NOTE: The portion of the text affected by the latest revision is indicated by a vertical line in the outer margins of the page.

TOTAL NUMBER OF PAGES IN THIS PUBLICATION IS 16, CONSISTING OF THE FOLLOWING:

Page  
No.

Title ..... Apr 1/83  
Blank ..... Apr 1/83  
A ..... Apr 1/83  
B Blank ..... Apr 1/83  
1 thru 4 ..... Apr 1/83  
4.1 ..... Apr 1/83  
4.2 Blank ..... Apr 1/83  
5 thru 10 ..... Apr 1/83

\* The asterisk indicates pages revised, added, or deleted by the current revision.

SECTION I  
INTRODUCTION

1-1. IDENTIFICATION.

1-2. This publication provides operation and maintenance instructions for Aircraft Refrigeration Units Part No. 2200165-1, 2200165-2 and 2200165-3, manufactured by AiResearch Manufacturing Company, Division of The Garrett Corporation, Torrance, California.

1-3. PURPOSE AND LEADING PARTICULARS.

1-4. This refrigeration unit is used to reduce the temperature of engine bleed air for use in an aircraft air conditioning system.

TABLE I. LEADING PARTICULARS

---

Cooling Turbine Part No. 572375-1, 572375-2, and 572375-3:	
Type .....	3 wheel
Lubricant .....	MIL-L-23699
Amount of Lubricant .....	120 cc (approx)
Weight .....	14.00 lb (approx)
Heat Exchanger Assembly Part No. 188682-1:	
Type .....	Air/Air
Weight .....	16.35 lb
Regulating Valve Part No. 898730-1:	
Type .....	Spring loaded normally open
Regulated Pressure .....	24 to 26 psig
Weight .....	2.10 lb max
Modulating Valve Part No. 978836-1:	
Type .....	Spring loaded normally closed
Operating Current .....	0 to 105 milliamps
Weight .....	2.35 lb max
Total Weight .....	40.00 lb (approx)

---

SECTION II  
DESCRIPTION

2-1. GENERAL. (See figure 1.)

2-2. The refrigeration unit consists of a three-wheel cooling turbine, a primary and secondary heat exchanger assembly, a fluid pressure regulating valve, and a modulating and shutoff valve.

2-3. DETAILED.

2-4. The three-wheel bootstrap-type cooling turbine consists of a turbine wheel, compressor impeller, and fan impeller mounted on a single shaft and arranged so that the fan and the turbine are located outboard with the compressor in the center. The turbine and compressor are placed back to back and mounted on one end of the shaft with the fan at the opposite end. A bearing assembly is located between the fan and the compressor.

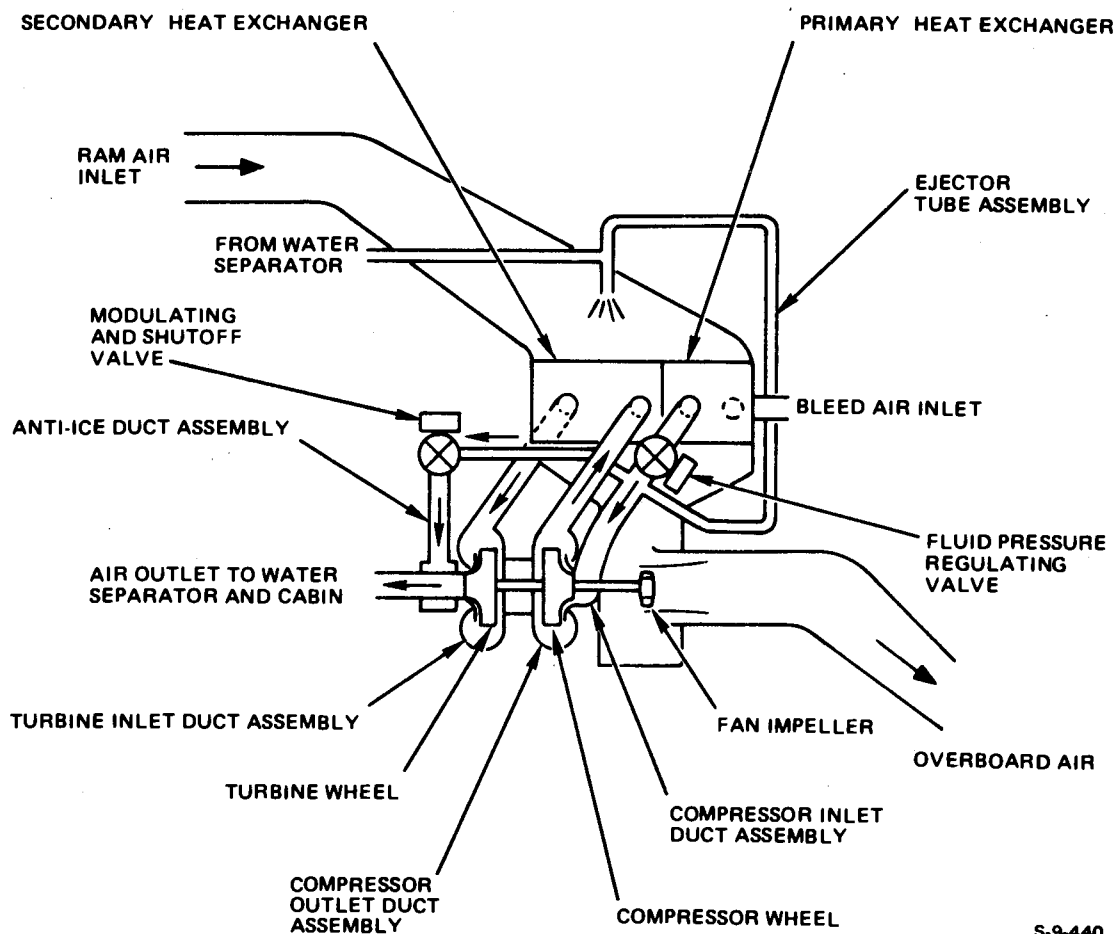

S-9-440

Figure 1. Aircraft Refrigeration Unit Schematic

2-5. The primary and secondary heat exchangers are air-to-air types consisting of a core assembly containing a series of plate tubes with integral tube fins separated by cooling air fins. The core assembly is enclosed within welded and brazed pan assemblies with integral fan and discharge ducts for directing hot inlet air and cooling air through the refrigeration unit. The heat exchanger is split so that approximately one third of the unit functions as the primary heat exchanger and two thirds as the secondary heat exchanger. The unit is of aluminum plate fin construction with each section a single pass crossflow configuration. Cooling air flows in parallel through the cold side passages of the core.

2-6. The fluid pressure regulating valve is a 2-inch line size, pneumatically actuated, spring loaded open butterfly-type valve which functions to control compressor inlet pressure to 25 psig.

2-7. The modulation and shutoff valve is a normally closed, 1-inch electro-pneumatically actuated right angle poppet-type valve. The valve controls the refrigeration unit cold air outlet to a minimum value of 35 degrees F (nominal) by modulating the flow of compressor inlet air to the anti-ice muff at the turbine discharge. The valve position is controlled by a torque motor which varies the valve actuator pressure in response to electrical signals from a 35 degree F temperature control/sensor located outside the refrigeration unit.

### SECTION III

#### OPERATION

3-1. Regulated hot bleed air entering the refrigeration unit passes first through the primary section of the heat exchanger where the air is partially cooled; then through the pressure regulator valve which controls bleed air pressure to a nominal value of 25 psig. The air then enters the compressor component of the three-wheel cooling turbine where the air undergoes an increase in pressure and temperature during the compression process. Upon leaving the cooling turbine compressor, the air flows through the secondary section of the heat exchanger where the air is cooled to nearly the temperature of ambient cooling air. Bleed air is then expanded through the turbine component of the three-wheel cooling turbine. This expansion process not only reduces the bleed air temperature well below that of the ambient air but produces shaft power to drive the compressor and fan. If the bleed air is cooled below the dewpoint during the expansion process in the turbine, water vapor in the air will condense out as small droplets (fog), or, if the temperature is below 32 degrees F, ice crystals form in the airstream. The cold turbine discharge air from the refrigeration unit is passed through a water separator (not part of the refrigeration unit) for moisture removal. Protection against ice formation in the water separator and downstream ducting during all modes of operation is achieved by the action of a temperature control/sensor (not part of the refrigeration unit) and a temperature/control valve to limit refrigeration unit discharge air to a minimum of 35°F (1.67°C).

3-2. The latent heat of condensed water collected in the water separator is utilized to increase the heatsink capability of the heat exchanger cooling air. The water injector nozzle assembly, which is part of the cooling turbine, uses a small quantity of bleed air from the heat exchanger outlet pan to eject and atomize this water and spray the water into the face of the secondary heat exchanger section of the heat exchanger core, thereby enhancing the heatsink capacity of the cooling air by evaporation.

3-3. About 70 percent of the power produced by the turbine is absorbed by the compressor and the remainder is absorbed by the fan, the function of which is to provide ambient cooling air for the heat exchanger during ground operation.

#### SECTION IV

##### SPECIAL SERVICE TOOLS

4-1. No special service tools are required.

#### SECTION V

##### PERIODIC INSPECTION

###### Note

The following inspection periods are recommendations only. If required, in order to be compatible with the nearest scheduled inspection periods, deviations not to exceed 10 percent of the recommended inspection periods are considered practical. Service experience will dictate actual inspection periods to be used.

###### 5-1. 150-HOUR INSPECTION.

a. Remove plug from oil drain port and allow oil to completely drain from cooling turbine. Install plug in oil drain port. Remove plug from oil fill port. Fill cooling turbine with oil (Specification MIL-L-23699) to top of fill port. Install plug in oil fill port.

■ 5-1A. (Deleted)

###### ■ 5-2. ON-CONDITION INSPECTION.

■ a. It is recommended that the cooling turbine be removed from the refrigeration unit and returned to an appropriate facility for repair/overhaul only if defective.

SECTION VI

MAINTENANCE

6-1. GENERAL.

a. Maintenance of the refrigeration unit is limited to replacement of components found defective in troubleshooting and the inspection outlined in Section V. Refer to Table II for troubleshooting information.

6-2. REPLACEMENT OF COOLING TURBINE. (See figure 2.)

- a. Remove anti-ice duct assembly (1) by removing clamps (2) and hose (3).

TABLE II. TROUBLESHOOTING INFORMATION

TROUBLE	PROBABLE CAUSE	REMEDY
Conditioned air output temperature too high.	Obstruction in cooling ram air duct.	Locate and remove obstruction.
	Leaking joints or connections.	Tighten loose joints or connections.
	Defective cooling turbine.	Replace cooling turbine.
	Defective primary or secondary heat exchanger.	Replace heat exchanger.
	Defective modulation and shutoff valve.	Replace valve.
	Defective fluid pressure regulating valve.	Replace valve.
	Flapper valve stuck open.	Repair or replace flapper valve.
Conditioned air output temperature too cold.	Defective modulation and shutoff valve.	Replace valve.
	Defective low limit sensor.*	Replace low limit sensor.
	Low limit sensor wiring loose or defective.	Tighten or replace wiring.
Oil mist in refrigeration unit discharge duct.	Defective cooling turbine.	Replace cooling turbine.
Excessive airflow.	Defective fluid pressure regulating valve.	Replace valve.

\*Not part of refrigeration unit.

- b. Remove remaining clamps (2) and hose (3) from turbine inlet duct.
- c. Remove compressor outlet duct assembly (4) by removing screws (5), washers (6), and packing (7).
- d. Remove compressor inlet duct assembly (8) by removing clamps (9) and hose (10).



- e. Remove screws (10A), washers (10B), flange (10C), dampener (10D), flappers (10E), and retainer halves (10F, 10G). If flappers (10E) are torn, wrinkled, or show evidence of deterioration, replace flappers.
- f. Remove bracket assembly (14), bolts (15), washers (16), and attaching parts.
- g. Remove cooling turbine (17) from plenum assembly (11) by removing bolts (12, 13).
- h. On Aircraft Refrigeration Unit Part No. 2200165-2, remove screws (16A), cover plate (16B), and adapter assembly (16C) from cooling turbine (17A). On Aircraft Refrigeration Unit Part No. 2200165-3, remove screws (16D), washers (16E), covers (16F), gasket (16G), cover assembly (16H), and adapter assembly (16J) from cooling turbine (17B).
- i. On Aircraft Refrigeration Unit Part No. 2200165-2, install adapter assembly (16C), cover plate (16B), and screws (16A) on replacement cooling turbine (17A). On Aircraft Refrigeration Unit Part No. 2200165-3, install adapter assembly (16J), cover assembly (16H), gasket (16G), covers (16F), washers (16E), and screws (16D) on replacement cooling turbine (17B). Torque screws (16A, 16D) to 10 pound-inches maximum. Safetywire screws, using MS20995C20 Lockwire.
- j. Install replacement cooling turbine (17) in plenum assembly (11) with bolts (12, 13); cross-tighten bolts. After bolts are installed, check that cooling turbine does not bind.
- k. Install bracket assembly (14) by installing bolts (15), washers (16), and attaching parts. The two bolts which secure the bracket assembly to the cooling turbine must be torqued to 20 to 25 inch-pounds. Check that cooling turbine does not bind after bracket assembly is installed.
- l. Install retainer halves (10F, 10G), flappers (10E), dampener (10D), flange (10C) and secure with washers (10B) and screws (10A).

CAUTION

Install flappers (10E) as shown in figure 2.

- m. Install compressor inlet duct assembly (8) by installing clamps (9) and hose (10).
- n. Install compressor outlet duct assembly (4) by installing screws (5), washers (6), and packing (7).
- o. Connect turbine inlet duct by installing clamps (2) and hose (3).
- p. Install anti-ice duct assembly (1) by installing clamps (2) and hose (3).

6-3. REPLACEMENT OF FLUID PRESSURE REGULATING VALVE. (See figure 2.)

- a. Remove compressor inlet duct assembly (8) by removing clamps (18) and packing (19).
- b. Remove tube assembly (20).

c. Install replacement fluid pressure regulating valve (21) by installing tube assembly (20), clamps (18), and packing (19).

6-4. REPLACEMENT OF MODULATING AND SHUTOFF VALVE. (See figure 2.)

- a. Remove anti-ice duct assembly (1) by removing pin (22) and packing (23).
- b. Remove tube assembly (24).
- c. Remove nut on end of tube of compressor inlet duct assembly (8).
- d. Remove bolts (25), washers (26), and shims (27, 28, 29).
- e. Install replacement modulating and shutoff valve (30) on heat exchanger assembly (37) by installing bolts (25), washers (26), and shims (27, 28, 29).
- f. Install attaching nut on end of tube of compressor inlet duct assembly (8).
- g. Install tube assembly (24).
- h. Install anti-ice duct assembly (1) by installing pin (22) and packing (23).

6-5. REPLACEMENT OF AIR/AIR HEAT EXCHANGER ASSEMBLY. (See figure 2.)

- a. Remove turbine inlet duct connection by removing clamps (2) and hose (3).
- b. Remove fluid pressure regulating valve (21) by removing clamps (18) and packing (19).
- c. Remove modulating and shutoff valve (30) by removing bolts (25), washers (26), and shims (27, 28, 29).
- d. Remove compressor outlet duct assembly (4) by removing nuts (31), washers (32), studs (33), and coupling (34).
- e. Remove plenum assembly (11), with cooling turbine (17) attached, by removing bolts (35) and washers (36).
- f. Install replacement heat exchanger assembly (37) on plenum assembly (11) by installing bolts (35) and washers (36). Apply adhesive-sealant (Military Specification MIL-A-46106A) between heat exchanger (37) and plenum assembly (11).
- g. Install compressor outlet duct assembly (4) by installing nuts (31), washers (32), studs (33), and coupling (34).
- h. Install modulating and shutoff valve (30) by installing bolts (25), washers (26), and shims (27, 28, 29).
- i. Install fluid pressure regulating valve (21) by installing clamps (18) and packing (19).
- j. Connect turbine inlet duct by installing clamps (2) and hose (3).

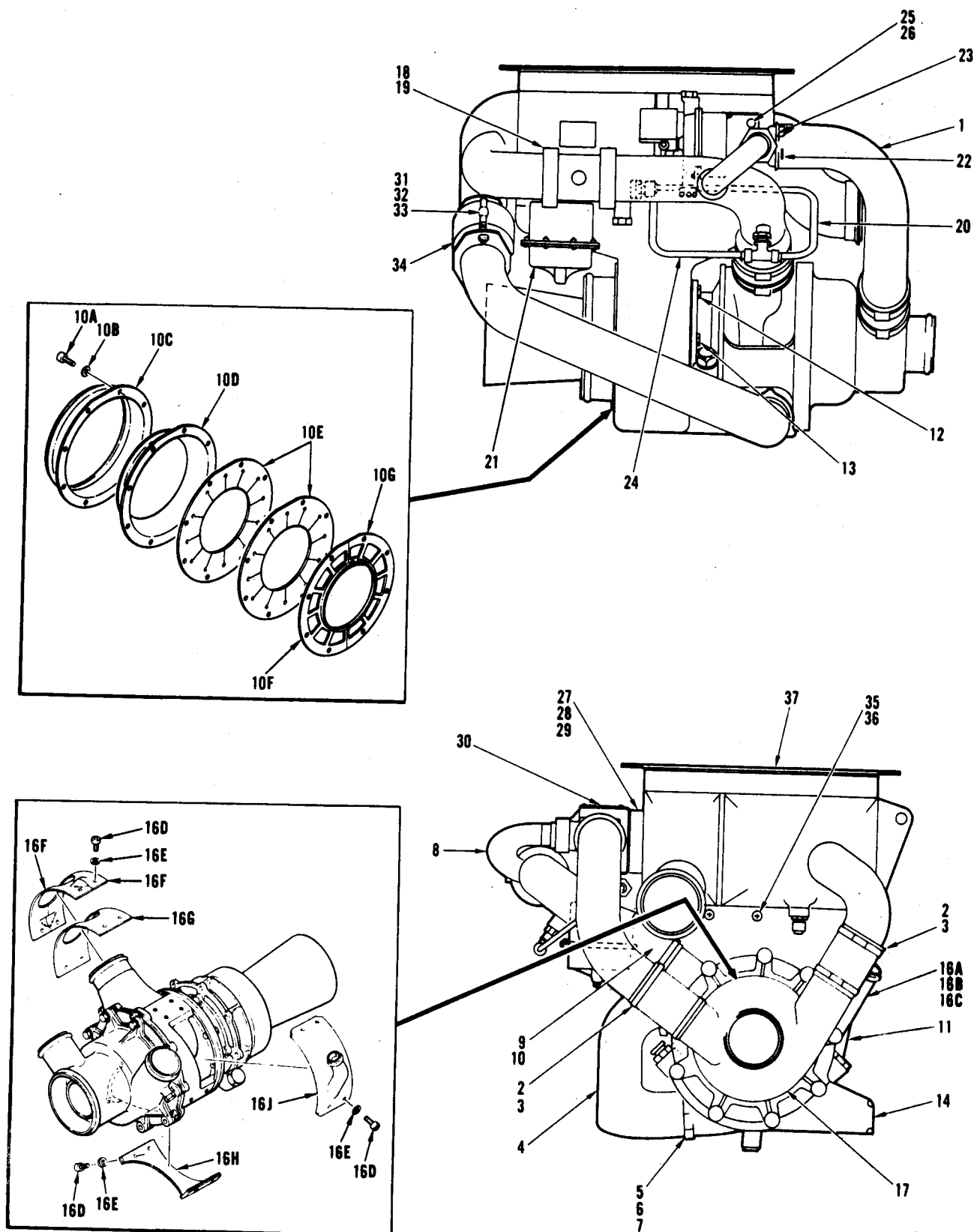

Figure 2. Aircraft Refrigeration Unit

E 9-520

TABLE III. LIST OF REPLACEABLE PARTS

Fig. and Index No.	Part No.	Nomenclature	Usage Code	No. Reqd
2	2200165-1	AIRCRAFT REFRIGERATION UNIT .....	A	RF
	2200165-2	AIRCRAFT REFRIGERATION UNIT .....	B	RF
	2200165-3	AIRCRAFT REFRIGERATION UNIT .....	C	RF
-1	2200278-1	ANTI-ICE DUCT ASSEMBLY .....		1
-2	WWD74KS3	CLAMP, STRAP (V66295) (AiR Spec No. 211-044-9013) .....		4
-3	171856-23	HOSE (V99135) (AiR Spec No. 171856-1) .		2
-4	2200388-1	DUCT ASSEMBLY, COMPRESSOR OUTLET .....		1
-5	NAS1351C3-12	SCREW .....		3
-6	AN960PD10L	WASHER .....		9
-7	MS9068-032	PACKING .....		1
-8	2200277-1	DUCT ASSEMBLY, COMPRESSOR INLET .....		1
-9	MS35842-13	CLAMP, STRAP .....		2
-10	171856-22	HOSE (V99135) (AiR Spec No. 171856-1) .		1
-10A	NAS1352C08-10	SCREW .....		8
-10B	AN960PD8L	WASHER .....		8
-10C	2200403-1	FLANGE, COOLING AIR DISCHARGE .....		1
-10D	2200508-1	DAMPENER, FLAPPER VALVE .....		1
-10E	2200394-1	FLAPPER, CHECK VALVE .....		2
-10F	2200397-1	RETAINER HALF, FLAPPER VALVE .....		1
-10G	2200397-2	RETAINER HALF, FLAPPER VALVE .....		1
-11	2200383-1	PLENUM ASSEMBLY .....		1
-12	AN3C4A	BOLT .....		6
-13	AN3CH4A	BOLT .....		2
	AN3C5A	BOLT (alternate part) .....		RF
-14	2200389-1	BRACKET ASSEMBLY, ACM SUPPORT .....		1
-15	AN3C4A	BOLT (not illustrated) .....		6
	AN3C5A	BOLT (not illustrated) (alternate part)		6
-16	AN960PD10L	WASHER (not illustrated) .....		6
-16A	NAS1351C3-10	SCREW .....	B	4
-16B	2201979-1	PLATE, COVER .....	B	1
-16C	2201977-1	ADAPTER ASSEMBLY .....	B	1
-16D	NAS1351C0844	SCREW .....	C	12
-16E	AN960PD8L	WASHER .....	C	12
-16F	2204007-1	COVER .....	C	2
-16G	2204008-1	GASKET .....	C	1
-16H	2204006-1	COVER ASSEMBLY .....	C	1
-16J	2204062-1	ADAPTER ASSEMBLY .....	C	1
-17	572375-1	COOLING TURBINE .....	A	1
-17A	572375-2	COOLING TURBINE .....	B	1
-17B	572375-3	COOLING TURBINE .....	C	1
-18	4265-281SH	CLAMP (V94581) (AiR Spec No. 234- 510-9012) .....		2
-19	MS9068-136	PACKING .....		2
-20	2200392-1	TUBE ASSEMBLY, REGULATING .....		1
		VALVE SUPPLY PRESSURE		
-21	898730-1	VALVE, FLUID PRESSURE REGULATING .....		1

TABLE III. LIST OF REPLACEABLE PARTS (cont)

Fig. and Index No.	Part No.	Nomenclature	Usage Code	No. Reqd
2-22	MS24665-308	PIN .....		2
-23	MS9068-132	PACKING .....		1
-24	2200393-1	TUBE ASSEMBLY, MOD VALVE SUPPLY .....		1
		PRESSURE		
-25	NAS604-12	BOLT .....		2
-26	AN960C416L	WASHER .....		2
-27	2200384-1	SHIM, 0.020 in. thick .....		AR
-28	2200384-2	SHIM, 0.062 in. thick .....		AR
-29	2200384-3	SHIM, 0.125 in. thick .....		AR
-30	978836-1	VALVE, MODULATING AND SHUTOFF .....		1
-31	NAS1288-4	NUT .....		4
-32	NAS1288-4W	WASHER .....		4
-33	927562-1	STUD .....		2
-34	54A427	COUPLING (V14711) (AIR Spec No. 234- ..		1
		040-9001)		
	460-200	. SEAL, PERI (V14711) .....		1
-35	AN3C3A	BOLT .....		18
-36	AN960PD10L	WASHER .....		AR
-37	188682-1	HEAT EXCHANGER ASSEMBLY, AIR/AIR .....		1
		DUAL		

VENDOR NAMES AND ADDRESSES

<u>CODE</u>	<u>MANUFACTURER</u>
V14711 .....	General Connectors Corp, Burbank, CA
V66295 .....	Wittek Mfg Co, Chicago, IL
V94581 .....	National Utilities Corp, Monrovia, CA
V99135 .....	Flexco Div. Co, Sherwood Indust. Inc, Bell Gardens, CA

# **1124-24-WESTWIND**

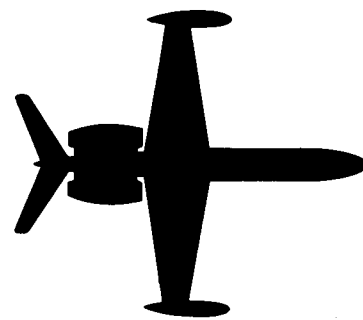

## **SERVICE INFORMATION LETTER**

---

---

**SIL NO. 37**

**REVISION 1**

**May 29, 1990**

**SUBJECT: EMERGENCY EXIT CHECKS**

### **CANCELLATION NOTICE**

This service information letter is hereby canceled. The information contained in this SIL has been incorporated in the 1124 Westwind Maintenance Manual, Chapter 5-20-02.

# 1124-WESTWIND

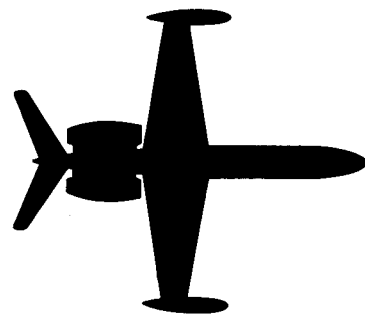

## SERVICE INFORMATION LETTER

S I L NO. 37

July 1, 1983

SUBJECT: EMERGENCY EXIT CHECKS

CANCELLED

Chapter 5 of the 1124/1124A Maintenance Manual, in 5-20-00 page 210 item (10) requires that the emergency exit seal be cleaned and lubricated at each 150 hour interval.

It has come to IAI's attention that some operators may not be accomplishing the 150 hour cleaning and lubrication due to the difficulty in reinstalling the emergency exit and the possibility of pressurization leaks after the exit has been removed. Keeping the seals clean and lubricated will prevent the seal from sticking and being damaged during removal of the emergency exit.

Flight crew members may wish to accomplish the exit removal to assure their proficiency and familiarity with the procedure. Complying with the required exit removal schedule will also assure that there will be no problem should an emergency occur.

### CAUTION

Flush adjustment of the emergency exit trim panel, at the top edge could result in the trim panel catching under the metal cornice thereby restricting removal of the emergency exit. To assure trim panel does not catch under edge of cornice spacers may be added as necessary under the wood strip containing trim retention magnets.



SUBSIDIARY OF ISRAEL AIRCRAFT INDUSTRIES, LTD.  
BEN GURION AIRPORT, ISRAEL

# 24-WESTWIND

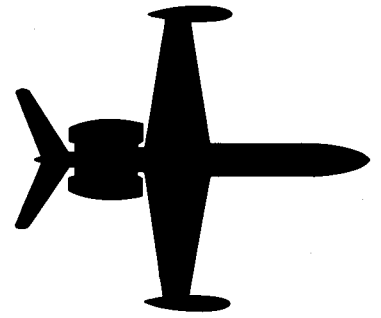

## SERVICE INFORMATION LETTER

---

---

SIL NO. 38

NOVEMBER 30, 1983

SUBJECT: INSPECTION AND SERVICE LIFE ON GAS STORAGE BOTTLES  
P/N 3753015 AND 3753015-501

Important changes are being made to the inspection requirements and life limits of gas storage bottles used in the thrust reverser and landing gear systems.

The following requirements will appear in Revision No. 12 to the 1124/1124A Maintenance Manual:

Gas Storage Cylinder P/N 3753015  
(Walter Kidde P/N 211597 or P/N 240737)

- a. Accomplish a visual inspection each year of both the exterior and interior of the bottle.
- b. Hydrostatic test bottle every three years.
- c. Bottles must be replaced after 15 years in service or 20,000 pressurization cycles, whichever occurs first.

#### NOTE

Time count for inspections, testing or replacement shall commence from date bottle was originally placed in service or certification date of aircraft.

Gas Storage Cylinder P/N 3753015-501  
(HTL Industries, Inc. P/N 36200071)

- a. Hydrostatic test bottle every five years. Time count shall commence from date bottle was originally placed in service or certification date of aircraft.
- b. There is no service life limit on this bottle. It should be replaced on condition.



SUBSIDIARY OF ISRAEL AIRCRAFT INDUSTRIES, LTD.  
BEN GURION AIRPORT, ISRAEL